

Operator's Manual

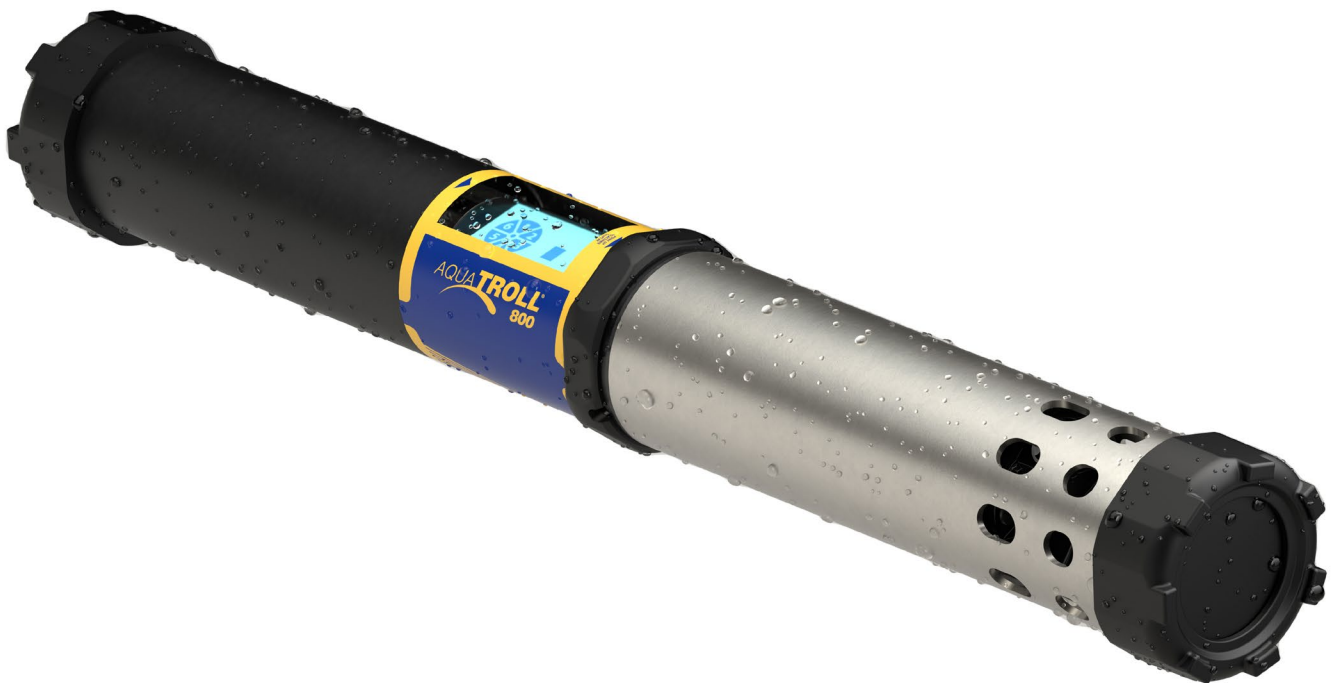

For Sales & Service Contact

geotech

2650 E. 40th Ave. • Denver, CO 80205
Phone 303-320-4764 • Fax 303-322-7242

1-800-833-7958

www.geotechenv.com

Information subject to change without notice. In-Situ, In-Situ logo, "Water Simplified", VuLink, RDO, RuggedCable, TROLL, BaroTROLL, HydroVu, VuSitu, Baro Merge, and Win-Situ are trademarks or registered trademarks of In-Situ Inc. ©2023. All rights reserved. This product may be covered by patents identified at www.in-situ.com/patents



For a list of local compliance representatives, see <https://in-situ.com/us/faq/regulatory-compliance/compliance-information/global-market-contacts>

Contents

Introduction	7
Serial Number Location	7
Instrument Description.....	7
Document Conventions	7
Unpacking and Inspecting	7
Safety	8
Intended Use	8
Instrument Specifications	9
External Power Source Requirements	10
About the Aqua TROLL 800	11
Features	11
Instrument Dimensions	11
End View	12
Sensor.....	12
Detail	12
Exploded View 1	12
Exploded View 2	12
Sensor Specifications	13
Sensor Summary	13
Solutions	14
Potential Interferents.....	15
RDO Cap Chemical Incompatibility	15
Conductivity/Temperature Sensor	15
Ammonium, Chloride, and Nitrate Interferent Concentrations	16
Fluorometer Wavelengths	17
Additional Information	17
Required Accessories	18
Communication Device	18
Telemetry + Communication Device	18
Software	18
Wireless TROLL Com.....	18
Cable.....	19
Sensors.....	19
Rugged Twist-Lock Cable	19
System Components	20

Aqua TROLL 800 Quickstart Guide	23
Getting Started	23
Box Contents.....	23
Parameters and Sensors	26
Using the RDO Sensor and Sensor Cap.....	26
Handling pH and Ion-Selective Electrode Sensors	26
Using Ion-Selective Electrode Sensors	27
Ammonium Sensor Requirements	27
Chloride, Nitrate, and pH/ORP Sensor Requirements.....	27
Derived Parameters.....	28
LCD Screen	29
Starting a Basic Log	29
Possible Port Statuses.....	29
Possible Power Statuses.....	29
Possible Log Statuses.....	29
Possible Connected Statuses.....	29
Error Messages	29
Micro SD Card.....	30
Calibrating Sensors	32
Solution-Based Calibration.....	32
Turbidity Sensor Calibration	32
Fluorometer Calibration	32
RDO 100% Saturation Calibration: Water Saturated Air.....	33
Calibrating with an Antifouling Restrictor	34
RDO Salinity Setting.....	34
Reported Depth.....	35
Batch Calibrating Sensors in VuSitu.....	38
Different Sensor Types (Quick Cal Solution)	38
Multiple Sensors of the Same Type	39
VuSitu Mobile App.....	40
VuSitu	40
Connected Instrument Screen	40
VuSitu Menu Options	41
Selecting with Long-press and Swipe	41
Live Readings in VuSitu.....	42
Snapshot Mode.....	42
Live Readings Mode.....	42
Viewing and Sharing Data	43

Downloading Your Data	43
Sharing Data	43
Viewing Data on a Mac or PC.....	43
VuSitu Locations	44
About VuSitu Locations	44
How to Create a Location.....	44
How to Edit or Delete a Location.....	44
How to Select a Location.....	45
Instrument Bluetooth	45
Disabling Instrument Bluetooth.....	45
Logging	46
Creating a Log with VuSitu	46
Remote Monitoring with VuLink	47
Claim VuLink.	47
Configure and deploy.....	47
Connect the instrument.	47
View data in HydroVu.	47
Barometric Compensation of Non-Vented Instruments.....	48
Configure the VuLink Log.....	48
Configure the Instrument Log.....	48
HydroVu	49
Connecting the Aqua TROLL 800 to a PLC or Data Logger	50
Flying Leads Wire Diagram	50
Configuring SDI-12 Settings	54
About SDI-12	54
Configure SDI-12 Settings in VuSitu.....	54
Modbus PLC Interface	54
Overview	54
Setting Up Instrument	55
Programming the PLC	55
Reading Device Information	55
Reading Parameters	56
Turning on Instrument Bluetooth with a PLC.....	56
Care and Maintenance	57
Storage.....	57
Cleaning the Sonde.....	57
Removing the Restrictor.....	57
Maintenance Schedule	58

User-Serviceable Parts.....	58
Wiper Maintenance	58
Replacing Desiccant.....	59
Replacing O-Rings	59
Cleaning and Storing the pH/ORP Sensor and Ion-Selective Electrode (ISE) sensors.....	60
Cleaning and Storing the RDO Sensor	62
Cleaning and Storing the Turbidity Sensor.....	62
Cleaning and Storing the Conductivity Sensor.....	63
Cleaning the Copper Antifouling Restrictor.....	63
Service and Repair.....	64
Obtaining Repair Service.....	64
Guidelines for Cleaning Returned Equipment	65
More Information	66
Declaration of Conformity	67
Appendix	69
Appendix A: Parameter Numbers and Locations	69
Appendix B: Unit IDs	72

Introduction

Serial Number Location

The instrument serial number is on the product label affixed to the instrument body. Serial numbers for individual sensors are engraved on the sensor body.

Instrument Description

The Aqua TROLL 800 uses the latest sensor and electronics technology to provide laboratory-quality measurements for field use. Parameters include water level, pH, dissolved oxygen, and more. The Aqua TROLL 800 is designed for applications that require parameters from up to 6 sensors with a single instrument. An optional water level/pressure sensor and a barometric pressure sensor are integrated into the sonde. Additional sensors may be selected and replaced to suit your project's needs. An optional motorized sensor wiper may also be included on the instrument.

Use the Aqua TROLL 800 for long-term monitoring in freshwater and marine environments. It's also ideal for the following applications:

- Coastal monitoring
- Surface water monitoring
- Environmental monitoring
- Regulatory compliance
- Aquaculture
- Remediation
- Stormwater monitoring
- Profiling

The built-in LCD screen displays battery status, connectivity info, and other vital information. Setup is easy with the VuSitu app and a Bluetooth-enabled mobile device. The Aqua TROLL 800 records data to internal memory and to a micro SD card simultaneously. It can also work with external PLCs and integrates seamlessly with VuLink telemetry for remote data monitoring.

Document Conventions

Throughout this document you will see the following symbols:



A checkmark highlights a tip or feature.



The exclamation point calls your attention to a requirement, safety issue, or important action that should not be overlooked.

Unpacking and Inspecting

Your equipment was carefully inspected before shipping. Check the equipment for any physical damage sustained during shipment. Notify In-Situ and file a claim with the carrier if there is any such damage; do not attempt to deploy or operate the instrument.



Save packing materials for future storage and shipping of your equipment.

Accessories may be shipped separately and should be inspected for physical damage and order fulfillment.

Safety



Read the safety information on this page before deploying or configuring your Aqua TROLL 800. If you have questions, contact In-Situ Technical Support for assistance.

- Use only D-cell alkaline batteries.
- Do not use the Aqua TROLL 800 in any manner not specified by the manufacturer.
- Do not use batteries of different ages or types.
- Do not submerge the Twist-Lock connector ends of the cable or instrument when they are not connected.
- Do not submerge the Wireless TROLL Com or your mobile device in liquid.
- Ensure that sensors or sensor plugs, are completely inserted into the ports, so that no liquid can enter the instrument.
- Ensure that the RDO Sensor Cap is pressed firmly over the sensor lens and is flush with the instrument before submerging in liquid.
- Replace the cable if insulation or connectors are damaged.
- Make sure the probe and sensor O-rings are clean and free of damage.

Intended Use

The Aqua TROLL® 800 Multiparameter Sonde is designed to be safe:

- during indoor or outdoor use;
- in ambient temperatures from -5 to 50° C;
- above or below 2000 m;
- in any relative humidity levels;



If the equipment is used in a manner not specified by the manufacturer, the protection provided by the equipment may be impaired.

Instrument Specifications

Operating temperature	-5 to 50° C (23 to 122° F) Nitrate and Ammonium Sensors: 0 to 40° C (32 to 104° F) Chloride Sensors: 0 to 50° C (32 to 122° F)
Storage temperature	Components without fluid: -40 to 65° C (-40 to 149° F) pH/ORP sensors: -5 to 65° C (23 to 149° F) Nitrate and Ammonium Sensors: 0 to 40° C (32 to 104° F) Chloride Sensors: 0 to 50° C (32 to 122° F)
Dimensions	Diameter: 7.21 cm (2.84 in) O.D. without bumpers; 8.23 cm (3.24 in) O.D. with bumpers Length: 63.70 cm (25.08 in.) (includes connector) With bail: 74.72 cm (29.42 in.)
Weight	3.23 kg (7.12 lbs) - includes all sensors, batteries, and bail
Wetted materials (sonde and sensors)	Buna-N, Noryl™, Nylon, Polyphenylsulfone, Polycarbonate, Acetal, EPDM/Polypropylene TPV, FKM Fluoroelastomer, Titanium, Flourocarbon Coating, Ceramic, Acrylic Adhesive Film
Environment rating	IP68 with all sensors and cable attached. IP67 with sensors removed or cable detached
Max pressure rating	Up to 350 PSI Ammonium/Nitrate up to 30 PSI
Communication	RS485/MODBUS, SDI-12, Bluetooth®
Reading rate	1 reading every 2 seconds for one parameter, no wipe
Internal memory	16 MB
Additional memory, micro SD card ²	16+ GB included, any size micro SD up to 32 GB accepted
Logging rate	1 minute to 99 hours
Logging modes	Linear, Linear Average
Data logging	50 logs (defined, scheduled to run, or stored)
LCD screen	Integrated display shows status of sonde, sensor ports, data log, battery, and connectivity
Internal power Battery life ³	(2) user-replaceable D-cell alkaline batteries > 6 months typical with wiping > 9 months typical without wiping
External power voltage ⁴ External power current ⁴	8-36 VDC Sleep: < 0.2 mA typical Measurement: 40 mA typical, 75 mA Max
Cable	Vented or non-vented polyurethane or vented Tefzel®

Hex screw driver	0.050 in. (1.3 mm)
Software interface	Android/iOS: VuSitu Mobile App (see app store for OS requirements) Data Services: HydroVu
Certifications	CE, FCC, WEEE, RoHS, UKCA Compliant
Warranty	2 year - sonde, sensors (excluding ISE Sensors) 1 year - Nitrate, Chloride, and Ammonium Sensors Other - see warranty policy at www.in-situ.com
Notes	Specifications are subject to change without notice. Android is a trademark of Google, Inc. Bluetooth is a trademark of Bluetooth SIG, Inc. Noryl is a registered trademark of SHPP Global Technologies B.V.

¹For 30 parameters > 100,000 data records, > 3 years at 15 minute interval. A single data record includes timestamp, temperature, RDO, pH, ORP, turbidity, and conductivity logged in Linear or Linear Average mode.

²Log data recorded to SD card in comma delimited variable (CSV) file format.

³Logging all sensors at 15 minute interval on 2 D-cell alkaline batteries. Battery life dependent on site conditions and wiping.

⁴Dependent on display and wiping

External Power Source Requirements



Current from an external power source must not exceed 4 amps.

About the Aqua TROLL 800

The Aqua TROLL 800 is a scientific instrument for water monitoring. It's capable of measuring numerous water-quality parameters at the same time. These parameters include:

- pH
- ORP
- Dissolved oxygen
- Turbidity
- Conductivity
- Temperature
- Pressure
- BGA-PE Fluorescence
- BGA-PC Fluorescence
- Chloride
- Chlorophyll-a Fluorescence
- Nitrate
- FDOM Fluorescence
- Crude oil Fluorescence
- Fluorescein
- Rhodamine
- Total Dissolved Solids
- Total Suspended Solids

Features

This instrument supports six removable wet-mate sensors and an optional wiper to keep sensor faces clean.

The Aqua TROLL includes an LCD screen that displays sensor status and instrument details. Additionally, the Aqua TROLL 800 includes internal memory and logging capabilities.

Instrument Dimensions



Exploded View 1

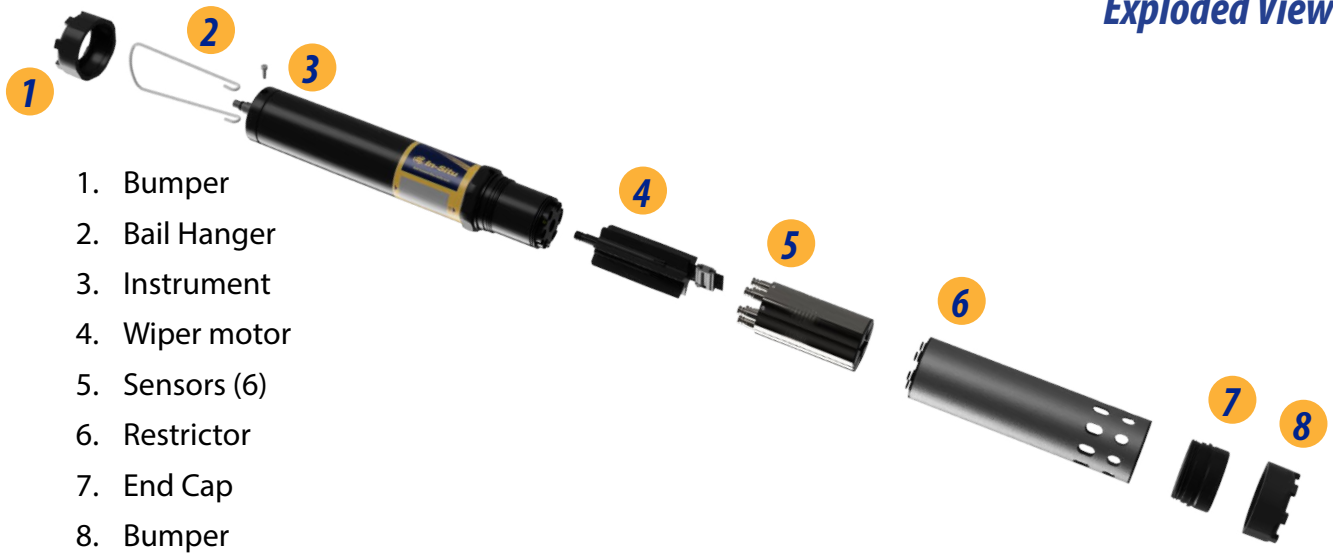

Exploded View 2



End View

Flat edge of connector aligns with flat edge of Rugged Cable.



Sensor Detail

6 Interchangeable sensors

Wiper or wiper plug



Sensor Specifications

Sensor Summary

Sensors	Expected Lifetime*	Recommended Calibration Frequency	Pressure Rating - PSI	Usable Depth		Operational Temperature Range
				m	ft	
pH/ORP	2 years or greater**	10 to 12 weeks**	350	250	820	- 5 to 50° C
RDO	2 years or greater	12 months**	350	250	820	- 5 to 50° C
Conductivity	2 years or greater	User calibration only if needed	350	250	820	- 5 to 50° C
Temperature	2 years or greater	NA	350	250	820	- 5 to 50° C
Turbidity	2 years or greater	User calibration only if needed	350	250	820	- 5 to 50° C
Pressure	2 years or greater	User calibration only if needed	12.8	9	30	- 5 to 50° C
			14.2	10	33	
			42.7	30	100	
			108	76	250	
			142	100	328	
			285	200	650	
			350	250	820	
Barometric Pressure	2 years or greater	User calibration only if needed	NA	NA	NA	- 5 to 50° C
Ammonium	6 to 12 months**	Monthly**	30	25	70	0 to 40° C
Chloride	1 year or greater**	Monthly**	350	250	820	0 to 50° C
Nitrate	6 to 12 months**	Monthly**	30	25	70	0 to 40° C
Chlorophyll a	2 years or greater	User calibration only if needed	350	250	820	- 5 to 50° C
BGA-PC	2 years or greater	User calibration only if needed	350	250	820	- 5 to 50° C
BGA-PE	2 years or greater	User calibration only if needed	350	250	820	- 5 to 50° C
Rhodamine	2 years or greater	User calibration only if needed	350	250	820	- 5 to 50° C
Fluorescein	2 years or greater	User calibration only if needed	350	250	820	- 5 to 50° C
FDOM	2 years or greater	User calibration only if needed	350	250	820	- 5 to 50° C
Crude Oil	2 years or greater	User calibration only if needed	350	250	820	- 5 to 50° C

* Expected lifetime includes total shelf life and deployment lifetime.

** Lifetime and calibration frequency depend on site and storage conditions.

Solutions

Solution	Shelf Life - Unopened	Shelf Life - Opened
Quick Cal	4 months. Store in a cool, dark place. Shake before use.	7 to 21 days (± 10 mV, ± 0.05 pH, ± 50 $\mu\text{S}/\text{cm}$)
ZoBell's	9 months. Store in a cool, dark place.	3 to 6 months
Low Conductivity (147 $\mu\text{S}/\text{cm}$)	12 months	Hours (± 1 $\mu\text{S}/\text{cm}$, check before use)
Other Conductivity	12 months	3 to 6 months
pH Calibration Buffers	24 months	3 to 6 months
Sensor Reference Filling Solution	24 months	12 months
pH Storage Solution	24 months	12 months
Sodium Sulfite	12 months	3 to 6 months
Turbidity	12 months	12 months from expiration date
Deionized Water	24 months	Hours, check before use for calibration
Ammonium	12 months	3 to 6 months
Chloride	12 months	3 to 6 months
Nitrate	12 months	3 to 6 months

Potential Interferents

pH

Sodium salts (at pH >12)

Dissolved Oxygen

Temperature, atmospheric pressure, salinity, chlorinity

Ammonium

Cesium, Potassium, Thallium, pH, Silver, Lithium, Sodium

Nitrate

Perchlorate, Iodide, Chlorate, Cyanide, Bromide, Nitrite, Hydrogen Sulfide (bisulfite), Hydrogen Carbonate (bicarbonate), Carbonate, Chloride, Dihydrogen Phosphate, Hydrogen Phosphate, Phosphate, Acetate, Fluoride, Sulfate

Conductivity

Temperature

ORP

Ions that are stronger reducing agents than hydrogen or platinum, e.g., chromium, vanadium, titanium, etc.

Chloride

Hydroxide, Ammonia, Thiosulfate, Bromide, Sulfide, Iodide, Cyanide

BGA-PC, BGA-PE, Chlorophyll a, Rhodamine WT
Turbidity

RDO Cap Chemical Incompatibility



The following chemicals will damage the RDO sensing element.

- Alcohols > 5%
- Hydrogen peroxide > 3%
- Sodium hypochlorite (commercial bleach) > 3%
- Gaseous sulfur dioxide
- Gaseous chlorine
- Do not use in organic solvents (e.g., acetone, chloroform, methylene chloride, etc.), which may destroy the sensing element

Conductivity/Temperature Sensor



Soaking the Conductivity/Temperature sensor in vinegar for longer than one hour can cause serious damage.

Ammonium, Chloride, and Nitrate Interferent Concentrations

Ammonium

The table below lists concentrations of possible interfering ions that cause 10% error at various levels (in ppm) of NH_4^+ .

Ion	100 ppm NH_4^+	10 ppm NH_4^+	1 ppm NH_4^+
Cesium (Cs^+)	100	10	1
Potassium (K^+)	270	27	2.7
Thallium (Tl^+)	3100	310	31
pH (H^+)	pH 1.6	pH 2.6	pH 3.6
Silver (Ag^+)	270,000	27,000	2,700
Lithium (Li^+)	35,000	3,500	350
Sodium (Na^+)	11,100	1,100	110

Chloride

The table below lists concentrations of possible interfering ions that cause 10% error at various levels (in ppm) of Cl^- .

Ion	100 ppm Cl^-	10 ppm Cl^-	1 ppm Cl^-
Hydroxide (OH^-)	3,840	384	38.4
Ammonia (NH_3)	6	0.6	0.06
Thiosulfate ($\text{S}_2\text{O}_3^{2-}$)	3	0.3	0.03
Bromide (Br^-)	0.68	0.068	6.8×10^{-3}
Sulfide (S^{2-})	9×10^{-5}	9×10^{-6}	9×10^{-7}
Iodide (I^-)	1.8×10^{-4}	1.8×10^{-5}	1.8×10^{-6}
Cyanide (CN^-)	1.5×10^{-5}	1.5×10^{-6}	1.5×10^{-7}

Nitrate

The table below lists concentrations of possible interfering ions that cause 10% error at various levels (in ppm) of NO_3^- .

Ion	100 ppm NO_3^-	10 ppm NO_3^-	1 ppm NO_3^-
Perchlorate (ClO_4^-)	7×10^{-2}	7×10^{-3}	7×10^{-4}
Iodide (I^-)	4	0.4	0.04
Chlorate (ClO_3^-)	30	3	0.3
Cyanide (CN^-)	20	2	0.2
Bromide (Br^-)	400	40	4
Nitrite (NO_2^-)	230	23	2
Hydrogen Sulfide (HS^-)	230	23	2

Bicarbonate (HCO ₃ ⁻)	440	440	44
Carbonate (CO ₃ ²⁻)	8,600	860	86
Chloride (Cl ⁻)	7,600	760	76
Dihydrogen Phosphate (H ₂ PO ₄ ⁻)	34,640	3,464	346
Hydrogen Phosphate (HPO ₄ ²⁻)	34,300	3,430	343
Phosphate (PO ₄ ³⁻)	33,900	3,390	339
Acetate (OAc ⁻)	104,200	10,420	1,042
Fluoride (F ⁻)	81,400	8,140	814
Sulfate (SO ₄ ²⁻)	685,700	68,570	6,857

Fluorometer Wavelengths

Sensor	Excitation Wavelength (nominal)	Detection Wavelength
Chlorophyll a	430 nm	675 nm to 750 nm
BGA-PC	590 nm	640 nm to 690 nm
BGA-PE	498 nm	575 nm to 625 nm
Rhodamine	530 nm	580 nm to 660 nm
Fluorescein	462 nm	525 nm to 570 nm
FDOM	375 nm	455 nm to 530 nm
Crude Oil	365 nm	430 nm to 505 nm

Additional Information

For additional sensor details including accuracy, range, resolution, methodology, detection limits, response time, and more, view the [Aqua TROLL specification sheet at www.in-situ.com](http://www.in-situ.com).

Required Accessories

Communication Device

You can use a communication device to calibrate, configure and deploy the Aqua TROLL 800.



Wireless TROLL Com

Provides power to the Aqua TROLL 800 to extend battery life.

Calibrate, configure, and deploy with a Bluetooth-enabled Android or iOS device.

Telemetry + Communication Device



VuLink

Provides power to the the Aqua TROLL 800 in remote-monitoring applications

Calibrate, configure, and deploy with a Bluetooth-enabled Android or iOS device.

Send data to HydroVu or an external FTP Server

Software



VuSitu Mobile App

Calibrate, configure and deploy the Aqua TROLL 700 from a Bluetooth-enabled Android or iOS device.

Get it from your device's app store.

Cable



Rugged Twist-Lock Cable

Connects the Aqua TROLL 800 to a Wireless TROLL Com or VuLink.

Vented or non-vented.

Stripped and tinned available for connecting to 3rd-party equipment

Sensors



Available Sensors

1. Temperature
2. Conductivity/temperature
3. pH/ORP
4. RDO
5. Turbidity
6. Ammonium
7. Chloride
8. Nitrate
9. Chlorophyll a Fluorescence
10. BGA-PC Fluorescence
11. BGA-PE Fluorescence
12. Rhodamine WT
13. Fluorescein WT
14. FDOM Fluorescence
15. Crude Oil Fluorescence

System Components

Sensors	
RDO Sensor - includes RDO-X Cap	0063450
RDO Sensor - includes RDO Fast Cap	0038520
Combination pH/ORP Sensor	0063470
Turbidity Sensor	0063480
Combination Conductivity/Temperature Sensor or standalone Temperature Sensor	0063460, 0063490
Ammonium Sensor	0033700
Nitrate Sensor	0033710
Chloride Sensor	0033720
Chlorophyll A Sensor	0038900
Phycocyanin (BGA-PC) Sensor	0038920
Phycoerythrin (BGA-PE) Sensor	0038930
Rhodamine WT Sensor	0038890
Fluorescein WT Sensor	0096050
Crude Oil Sensor	0096060
Fluorescent Dissolved Organic Matter (FDOM) Sensor	0096070
Sensor Port Plugs (2)	0063510
Communications	
Wireless TROLL Com for Android	0031240
Mobile Device for Android	0064860
TROLL Com RS-232 Cable Connect	0056140
TROLL Com USB Cable Connect	0052500
TROLL Com RS-232 Direct Connect	0056150
TROLL Com USB Direct Connect	0052510
Accessories	Part Number
Alkaline Batteries (2)	0042020
Dual Titanium Restrictor/Storage Chamber	1012140
Rubber Bumpers (2)	1012150
Wiper or Wiper Port Plug	1012110, 1012130

Cable	
Stripped-and-tinned Cable with male connector	0053310
Twist-lock Bulkhead Connector	0053240
Twist-lock Backshell/Hanger, Titanium	0051480
Cable Extender	0051490
Large Desiccant (titanium connector)	0051810
Large Desiccant (ABS connector)	0053550
Small Desiccant (3 pack) - storage desiccant	0052230
Desiccant Refill Kit for Large or Outboard Desiccant	0029140
Calibration and Maintenance	
RDO Classic Cap Replacement Kit	0079790
pH/ORP Replacement Reference Junction Kit	0078990
Wiper Brush Kit	1012120
Maintenance Kit	1014170
Copper Antifouling Guard	1014500
Quick-Cal Solution for calibrating DO, Cond., pH & ORP	0033250
Dissolved Oxygen Calibration Kit	0032110
Conductivity Calibration Kit (Full)	0032090
Conductivity Calibration Kit (Low)	0032630
Conductivity Calibration Kit (High)	0032640
pH Calibration Kit	0032080
pH/ORP Calibration Kit	0032120
pH Storage Solution	0065370
Individual Calibration Solutions	See website
Ammonium Calibration Kit (includes 1 liter each: 14 ppm, 140 ppm, 1400 ppm, DI water)	0032140
Chloride Calibration Kit (includes 1 liter each: 35.5 ppm, 355 ppm, 3545 ppm, DI water)	0032150
Nitrate Calibration Kit (includes 1 liter each: 14 ppm, 140 ppm, 1400 ppm, DI water)	0032130
Fluorescein WT Solid State RFU Calibrator	1012180
FDOM Solid State RFU Calibrator	1012170
Crude Oil Solid State RFU Calibrator	1012190

RuggedCable System

RuggedCable Systems are custom-built, durable, direct-read cables that include the following items:

- Titanium twist-lock connectors for quick, reliable connections to the instrument, desiccant, and communication cable
- Metal shield beneath the cable jacket to prevent electrical interferences
- Kellems grip for secure instrument deployment
- Small desiccant for vented systems (for storage only)

Vented or Non-Vented Cable

Vented cable is used with vented pressure sensors to produce gauged measurements. The cable vent tube ensures that atmospheric pressure is applied to the back of the sensor diaphragm.

Non-vented cable is used with non-vented instruments for absolute measurements. Compensate absolute measurements by using a VuLink and HydroVu.



Vented cable is shipped with a small desiccant to protect against condensation. Larger desiccants are necessary for deployment.

Jacket Options

Tefzel (vented) or thermoplastic polyurethane (TPU, vented or non-vented)

Customizable Cable Lengths

Cables can be ordered up to 1,219 m (4,000 ft).

Cable Termination

Cables can be ordered with a twist-lock termination (female connector) on both ends that connect to the instrument, the TROLL Com Communication Device, desiccant, and other accessories.

Cables can also be ordered with stripped-and-tinned termination for wiring to a data logger or controller using SDI-12 or Modbus communication protocol.



1	RuggedCable System with female to female connectors
2	Stripped-and-tinned RuggedCable System with female connector
3	Stripped-and-tinned RuggedCable System with male connector (short length that converts a cable with a twist-lock connector to a stripped-and-tinned cable)



Box Contents

1. Instructions
2. Instrument with sensors and wiper or wiper plug installed
3. Hex Wrench
4. Screwdriver
5. RDO Sensor Cap (if RDO Sensor is included)
6. Batteries
7. pH/ORP or ISE Sensors (if selected)
8. Accessories
9. pH maintenance kit (if pH/ORP or ISE sensors are included)

Getting Started

1 Install the batteries.



Unscrew the battery cover to remove it.



Bend rubber cover back and insert the batteries.



Replace the battery cover.



Your Aqua TROLL 800 ships with all sensors installed except for pH/ORP or ISE sensors. If your instrument does not include pH/ORP or ISE sensors, all six sensors are installed by the factory. All sensors are factory calibrated and do not need to be recalibrated unless required by site procedures.

2 Install the RDO Cap (RDO sensor only).



Remove the restrictor.



Use included hex wrench to loosen set screw on RDO sensor.



Use the small hole at the bottom of the sensor to lever the sensor out.



Remove the dust cover from the RDO sensor.



Install the RDO cap on the sensor.



Insert RDO sensor into instrument sensor port.



Tighten screw at base of sensor with hex wrench. Do not overtighten.

3 Install the pH/ORP Sensor or ISE Sensors.



Remove tape and cap from sensor.



Apply a pea-sized drop of lubricant to sensor O-rings.



Insert sensor in empty sensor port.



Tighten screw at base of sensor with hex wrench. Do not overtighten.

4 Prepare Instrument for Deployment.



(Optional) Install restrictor with vent holes at base of instrument for calibration.



(Optional) Calibrate sensors. Calibration procedures may be found in user manual.



After calibration, flip the restrictor with the vent holes away from the center of the instrument.



Install the end cap on the restrictor for deployment.

5 Connect the Rugged Cable and communication device.

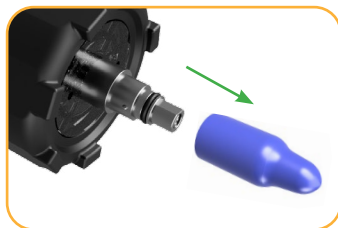

Remove protective caps from instrument and cable.

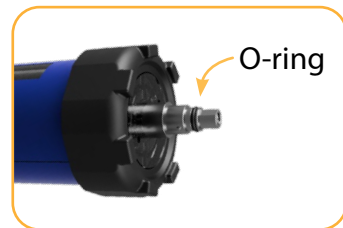

Apply a pea-sized drop of grease to the O-ring.

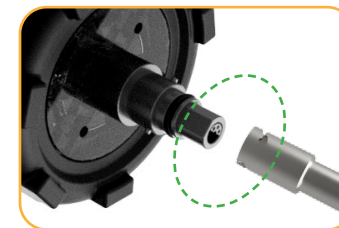

Align the flat edges of the instrument connector and the cable.

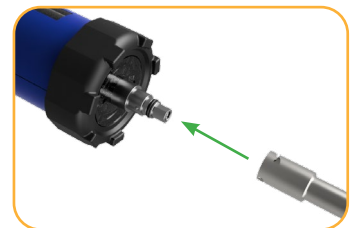

Slide connector into the cable end.

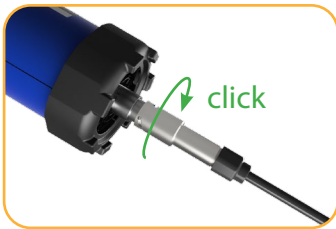

Twist and push the sleeve until you hear a click.



If desiccant is present, remove it from cable.



Align TROLL Com connector with cable end. Push and twist until you hear a click.

6 Connect to the software.



You must have the VuSitu mobile app to use the instrument with a mobile device. Download VuSitu from the Google Play Store or the Apple App Store.

iOS

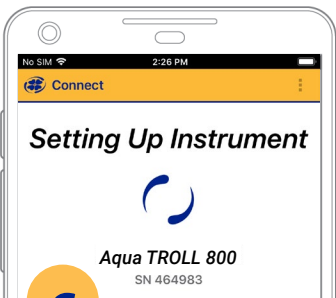

a

An iOS device automatically connects to the closest In-Situ instrument.

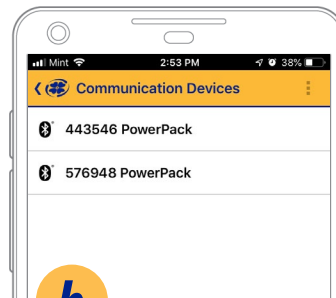

b

To connect to another instrument, press **Disconnect** and then **Choose or Add Device**. VuSitu displays a list of available connections.

Android

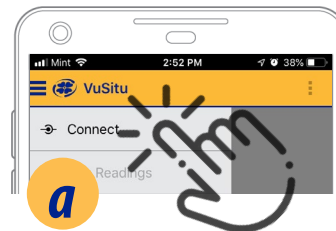

a

Launch VuSitu and tap **Connect**.

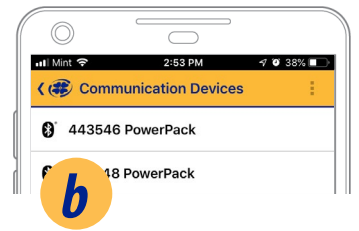

b

The app locates and displays nearby In-Situ devices.



c

Tap the serial number of the instrument or Wireless TROLL Com.

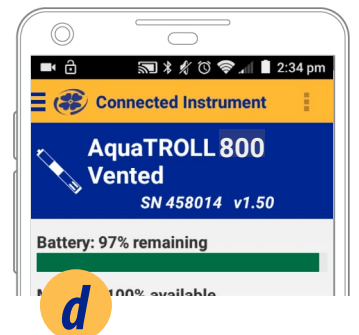

d

VuSitu displays the Connected Instrument screen when pairing is complete.



VuSitu's on-screen instructions will guide you through instrument calibration, logging, live readings, and data sharing.

Parameters and Sensors

Using the RDO Sensor and Sensor Cap



The wiper can severely reduce the life of the RDO Fast Cap. Wear will vary by application. Verify sensor performance prior to use and replace the Fast Cap if damaged.



Do not look directly at the sensor LED or point it at the eyes. Doing so can cause eye damage.

Handling pH and Ion-Selective Electrode Sensors



Salt may accumulate around the reference junctions of the ammonium, chloride, nitrate and pH sensors. Rinse with deionized water to remove any buildup.



Before using the **ISE sensors** for the first time, replace the reference filling solution. Condition the sensors by soaking in calibration standard for 4-24 hours prior to deployment. This step is not necessary for the pH sensor.

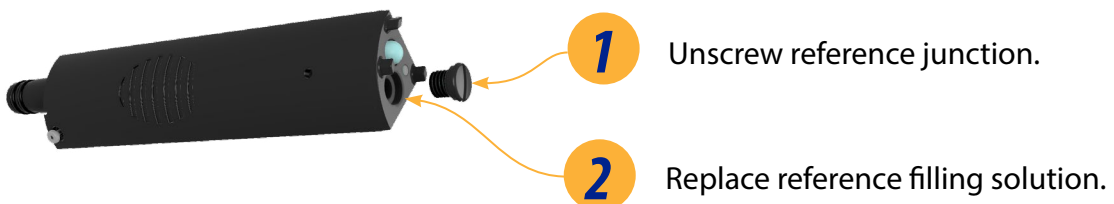

Using Ion-Selective Electrode Sensors



ISE sensors require one or more additional sensors to function. See the details below and install the required sensors to use an ISE.

Ammonium Sensor Requirements

**Conductivity/
Temperature Sensor**



or

Temperature Sensor



To calculate ammonia...

**Conductivity/
Temperature Sensor**



and

pH Sensor



Chloride, Nitrate, and pH/ORP Sensor Requirements

**Conductivity/
Temperature Sensor**



or

Temperature Sensor



Derived Parameters

VuSitu can derive estimates for additional parameters based on correlations with measured parameters. Scale factors for derived parameters are unique for each deployment site, so they must be determined by laboratory analysis of grab samples. Examples of derived parameters include:

- TDS (Derived from Conductivity and Temperature)
- TSS (Derived from Turbidity and Temperature)
- BGA-PC and BGA-PE Concentration (Derived from Relative Fluorescence)
- Chlorophyll a Concentration (Derived from Relative Fluorescence)
- Chlorophyll a Cell Count (Derived from Relative Fluorescence)
- FDOM Concentration (Derived from Relative Fluorescence)
- Crude Oil Concentration (Derived from Relative Fluorescence)

Enable derived parameters and input a scale factor in VuSitu under **Instrument Settings > Derived Parameters**.

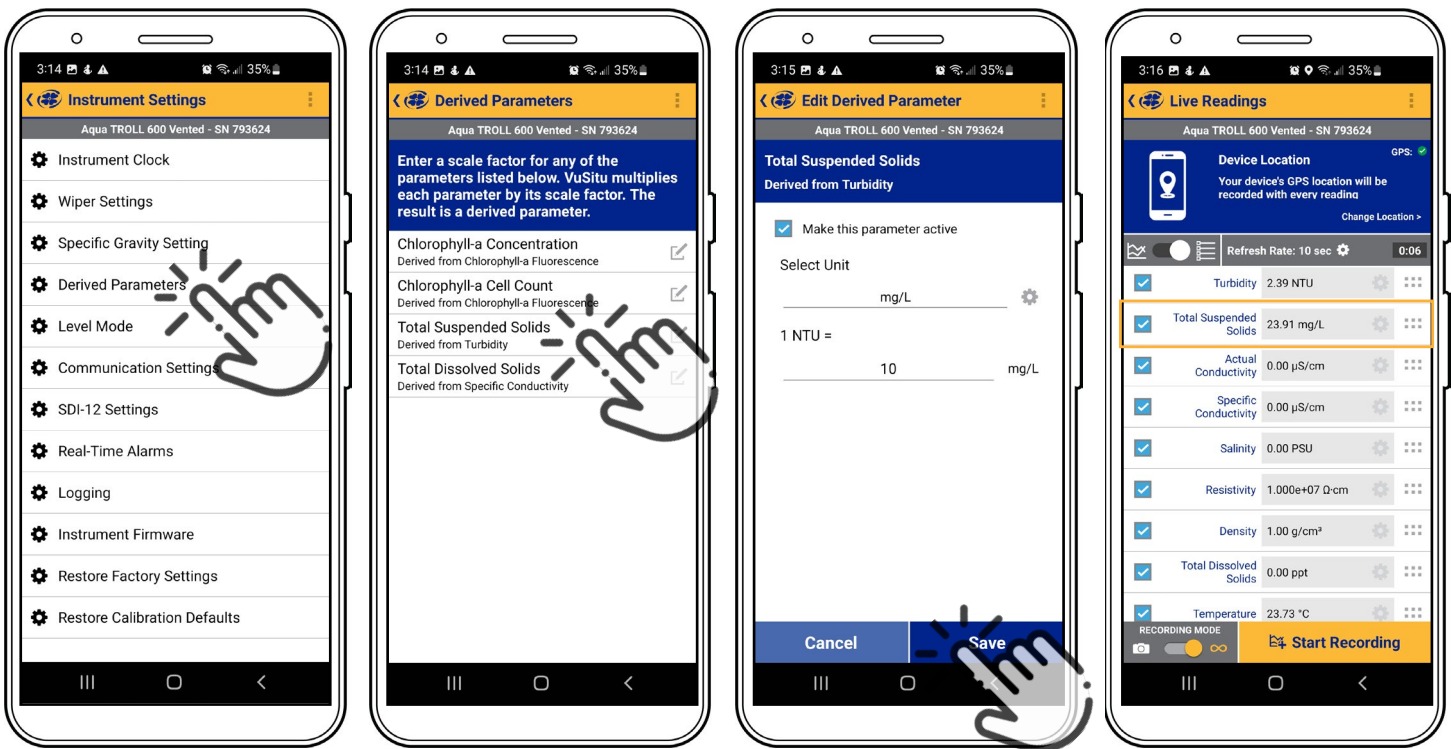

Select **Derived Parameters** in the **Instrument Settings** menu.

View the list of available derived parameters. Select the edit icon to configure a parameter.

Select units and enter a linear scale factor. Scale factors are highly site-specific and must be determined by laboratory analysis of grab samples.

The derived parameter is now listed next to measured parameters.

LCD Screen



View instrument status and start a basic log via the LCD screen.

Starting a Basic Log



Use the steps below to start a log when connection to VuSitu is not possible. If no logs are ready to start, a basic log will be created to record all available parameters every 15 minutes.



Remove the battery cover.



To create a basic log on the instrument, press the button inside the battery cover 5 times.



Replace the battery cover.



The LCD screen will show that the log has been started.

Possible Port Statuses



Sensors installed



Port plugs installed



Sensor/port error

Possible Power Statuses



Battery level indicator



External power provided



Battery below 10% or Battery error

Possible Log Statuses



Log is Running



Log is Scheduled



Log is Paused



No Log Set Up

Possible Connected Statuses



Connected via Bluetooth



Connected via cable

Error Messages



Port(s) empty



RDO Cap expired!

RDO cap is reaching the end of its expected lifespan.



Refer to the VuSitu section of this manual for information on Instrument Bluetooth.

Full-Text Messages

The LCD will display text messages instead of status icons when certain conditions are met. The highest priority status will display until it is resolved.

Text Message	Cause and Remedy
Close battery cover	Battery cover is not fully closed. Ensure the battery cover is tightened.
Install wiper	Wiper sensor port is open. Install wiper or wiper port plug into center port.
Install all sensors	Sensor ports are open. Install sensors or sensor port plugs.
Temperature Recommended	No Temperature or Conductivity/Temperature sensor detected. Install a sensor with Temperature.
Install RDO Cap	RDO Cap not detected on RDO sensor. Install RDO cap.
RDO Cap expired	RDO cap is reaching the end of its expected lifespan. Install a new RDO Cap if it is worn or damaged or if sensor is not calibrating properly.
RDO Cap: XXX days remaining	Temporary text message update on the lifespan of the RDO Cap.

Micro SD Card

The Aqua TROLL 800 uses a micro SD card for data storage. You can remove the SD card and replace it with another for data download, or use the same card. An SD card is not required to log data.

Removing the Micro SD Card

The micro SD card is housed in a slot near the positive battery terminal and the twist-lock connector.

1. Remove the battery cover from the end of the instrument.
2. Push the micro SD card in towards the instrument to release the card.
3. Remove the card from the slot.
4. To reinstall the card, push the card into the slot until you hear a click.

Downloading and Deleting Data from the Micro SD Card

1. Remove card from the sonde and insert it into a micro SD card adapter.
2. Insert the adapter into a PC or laptop.
3. Open the micro SD card using the file explorer.
4. Open the folder titled "Serial Number.LOG." For example, "424690.LOG."



Logs are named by date and then number. For example, a log started on November 12, 2022 would be named "22111200.CSV" - 22 is the year, 11 is the month, 12 is the day, and 00 is the log number. If multiple logs are recorded on the same day the last number will increase by one for each consecutive log.

5. Select the logs you wish to download and move them to the destination.
6. Select the logs you wish to delete and press Delete on the keyboard. Deleted logs cannot be recovered.

Error Code	Error Description	Recommended Actions
UC[0]	User Calibration (UC) Expired	1.) Perform a user calibration on the sensor in a known calibration standard 2.) Follow individual sensor instructions or user SOPs for calibration.
FC[0]	Factory Calibration (FC) Expired	Call (800-446-7488) or contact In-Situ Technical Support (support@in-situ.com). Send the instrument back to In-Situ for factory calibration
OL	Sensor Offline (OL) and no longer communicating with the instrument	1.) Remove sensor and check for water in the connection port. Dry sensor and sonde connector. Reinstall sensors. 2.) Remove two sensors and reinstall in separate port. 3.) Call (800-446-7488) or contact In-Situ Technical Support (support@in-situ.com).
WU[0]	Wiper Error - wiper is not turning correctly or interfering with sensor performance	1.) Inspect wiper to ensure surface is free of debris and the wiper is spinning correctly. 2.) Remove wiper brush and install a new brush holder with new brushes. 3.) Remove the wiper and check for water in the connection port. Dry the wiper port and the sonde connector. Reinstall wiper. 3.) Call (800-446-7488) or contact In-Situ Technical Support (support@in-situ.com).
ERR[0]	Sensor is performing outside of expected range	1.) Make sure the sensor is submerged in solution. 2.) Recalibrate sensor in a fresh batch of calibration standard. 3.) Reset sensor back to factory defaults and check reading in a calibration standard. Recalibrate. 4.) Call (800-446-7488) or contact In-Situ Technical Support (support@in-situ.com).
DIS[0]	Sensor is not set up correctly, being used outside of temperature or sensor range or returning a sentinel value due to internal malfunction or damage	1.) Verify that the RDO sensor cap is installed, the sensing foil is intact and the cap has not expired. 2.) Clean the surface of the sensor to remove any excess debris 3.) Verify that the instrument and sensors are not being used outside of temperature or sensor specifications. 4.) Verify that the sensor is not physically damaged 5.) Call (800-446-7488) or contact In-Situ Technical Support (support@in-situ.com).

Calibrating Sensors

Solution-Based Calibration

Use the solution-based procedure described below to calibrate all sensors except RDO and fluorometers (BGA-PC, BGA-PE, Chlorophyll-A, FDOM, Crude Oil, Fluorescein, and Rhodamine). You will need the following items.

- Calibration standard, or multiple standards for multi-point calibrations
- Bluetooth-enabled mobile device

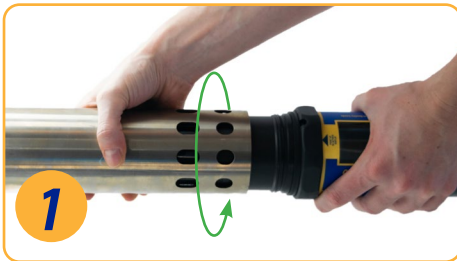

Place the restrictor in calibration mode (holes near the center of the instrument).

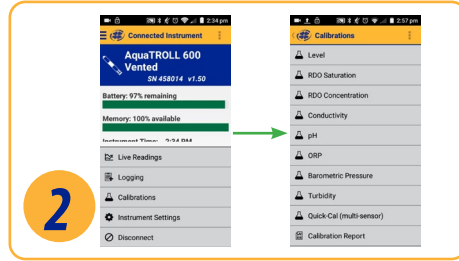

In VuSitu, click Calibrations from the Connected Instrument screen and choose sensor to calibrate.



Remove cap from instrument and pour 20-40 mL of DI water into restrictor.



Gently shake the sonde in a circular motion to rinse the inside of restrictor and sensors.



Discard the DI water and repeat rinsing procedure two more times with 20-40 mL of your first calibration standard.

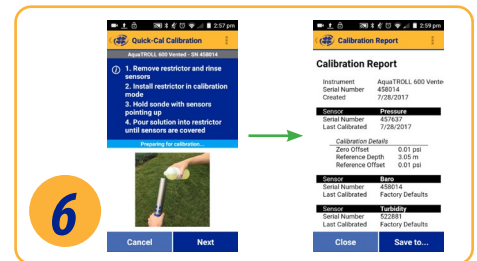

Pour 90 mL of calibration solution into the restrictor and cover with the end cap. Follow the instructions in VuSitu to start the calibration.

Turbidity Sensor Calibration



You must calibrate the turbidity sensor with In-Situ's turbidity standard, or formazin. The app may not automatically detect the formazin concentration. Instead, a field will appear in which you can enter the appropriate value. Select **Set User Defined** to begin calibrating with the new value. If you are using an In-Situ standard and the app does not automatically detect it, perform the sensor cleaning and maintenance procedure, then select **Retry Auto Detect**.

Fluorometer Calibration



Fluorometer sensors (BGA-PC, BGA-PE, Chlorophyll-A, FDOM, Crude Oil, Fluorescein, and Rhodamine) require more calibration solution than other solution-based calibrations. Use a solid-state calibrator for fluorometer calibrations if one is available. If solution-based calibration is required, use 180 mL of calibration solution for accurate calibration.



Do not look directly at the sensor LED or point it at the eyes. Doing so can cause eye damage from UV light emitted by the LED.



Place the restrictor in calibration mode (holes near the center of the instrument).



Connect to the VuSitu mobile app. Select **Calibrations**.

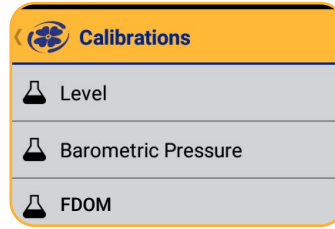

Select **FDOM** from the list of calibrations.



Place the calibrator in the end of the restrictor.



Enter the standard value from the top of the Calibrator.

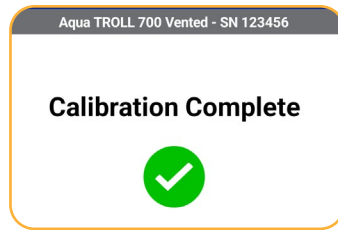

Follow the on-screen instructions to complete the calibration.



After calibrating, install the restrictor in deployment mode.

RDO 100% Saturation Calibration: Water Saturated Air

Use the procedure below to calibrate the Aqua TROLL 800 RDO sensor, or see the next section for an alternative method.

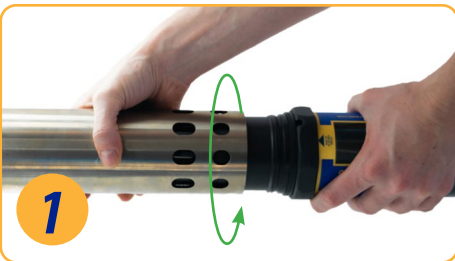

Place the restrictor in calibration mode (holes near center of instrument).

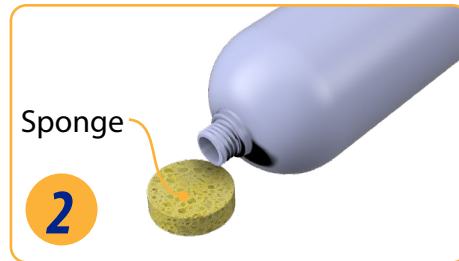

Saturate a small sponge with water.



Place the sponge on the restrictor cap.



Loosely install the end cap, keeping the sensor face dry and allowing for air flow.



Leave sponge in restrictor for five minutes.

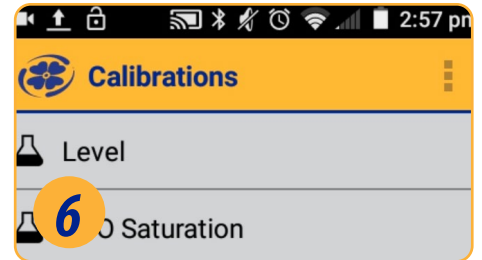

Follow the instructions in VuSitu to finish calibration.

Calibrating with an Antifouling Restrictor

When using an antifouling restrictor, do not flip the restrictor into calibration mode. Instead, follow the steps below.



Leave the restrictor in deployment mode. Slide the calibration sleeve over the holes.



Calibration sleeve is ready when it clicks into place and is flush with the end of the restrictor.



Continue the rest of the calibration as described above.

RDO Salinity Setting

The Aqua TROLL 800 includes automatic salinity compensation. This feature requires a conductivity sensor and RDO sensor. With both sensors installed, the sonde uses salinity compensation by default. To change the compensation value, follow these steps:

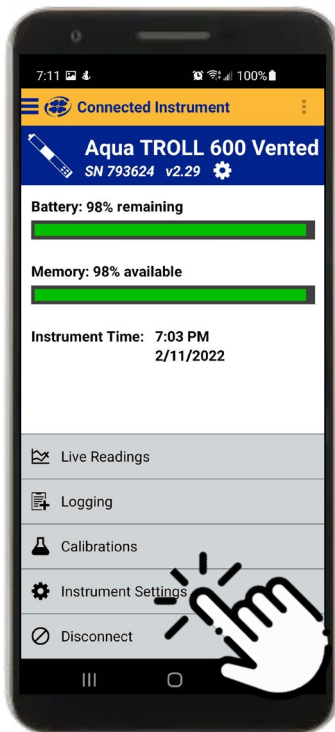

Select **Instrument Settings** from the menu at the bottom of the screen.

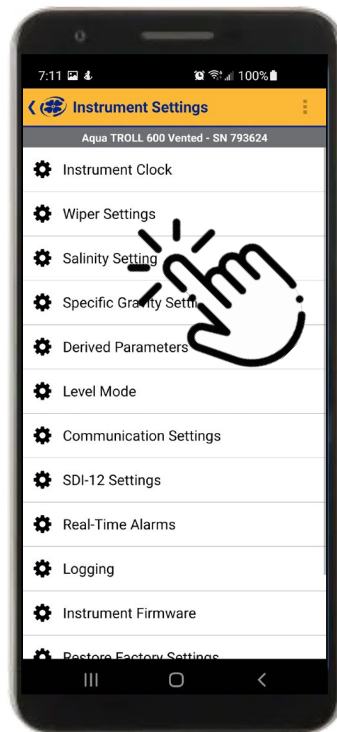

From the Instrument Settings menu, select **Salinity Setting**.

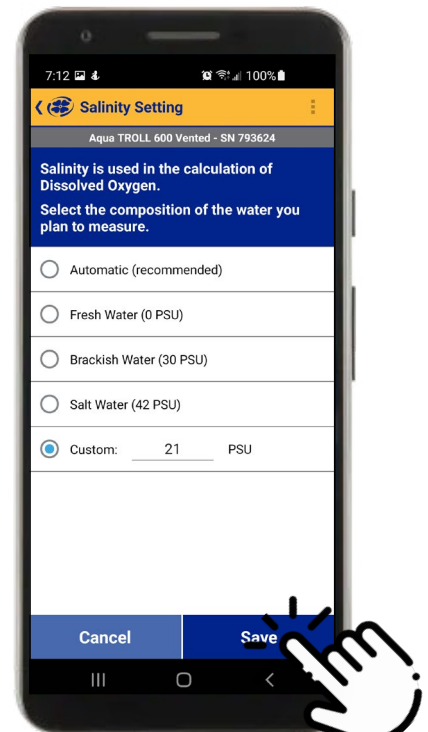

Enter your desired salinity compensation setting and press **Save**.

Reported Depth

If a pressure sensor is included, Aqua TROLL 800 uses its pressure reading and specific gravity value to calculate depth. The pressure sensor is located at the center of the instrument, but depth is reported at the smart sensor faces. An embedded gyroscope compensates for the distance between these sensors and allows the sonde to be deployed in any orientation (vertical, horizontal, angled).

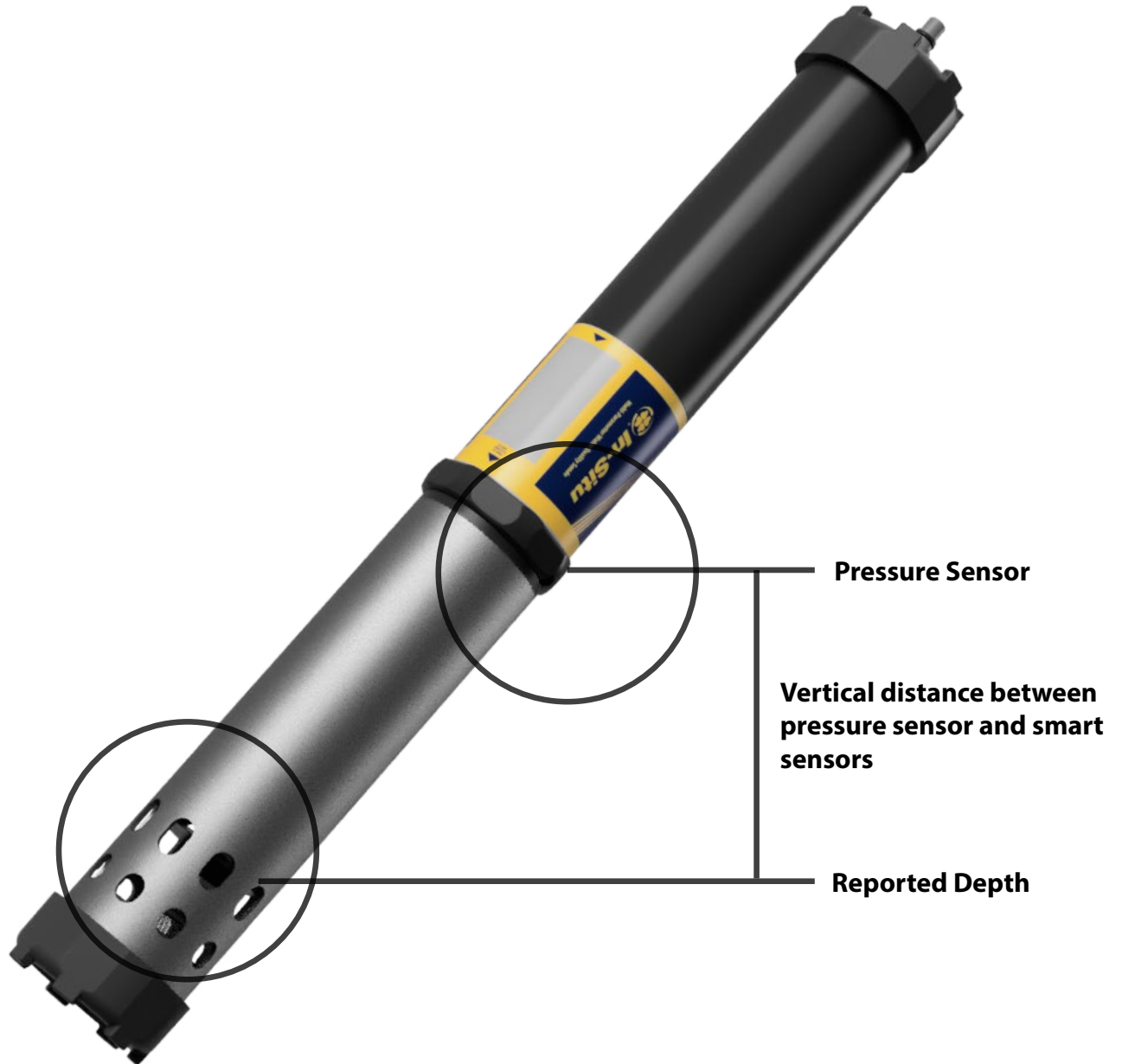

Calibration Frequency Recommendations

In-Situ sensors are factory calibrated across the entire range of each sensor, and thus achieve a very high degree of accuracy and stability for extended periods of time without user calibration. In-Situ recommends inserting the instrument into a known calibration standard to check the accuracy of a sensor prior to performing any user calibration if you suspect drift, unless a user calibration is required by a standard operating procedure.

Sensor	Recommended User Calibration Frequency	Recommended Factory Calibration Frequency	Notes
Conductivity	Only when required by user protocol	12 months	K-cell value: 0.7 to 1.3
Conductivity + Temperature	Only when required by user protocol	12 months	K-cell value: 0.7 to 1.3
pH	10 to 12 weeks or as required by user protocol or site conditions	12 months	Single point: Theoretical mV ± 30 mV 2- or 3-point Slope: -66 to 50 mV/pH 2- or 3-point Offset: ± 30 mV at pH 7
ORP	10 to 12 weeks or as required by user protocol or site conditions	12 months	Offset: ± 30 mV
RDO	12 months or as required by user protocol	12 months	2-point Slope: 0.7 to 1.3 2-point Offset: ± 0.3 mg/L
Temperature	Only when required by user protocol	Only when required by user protocol	Offset: ± 0.5
Turbidity	Only when required by user protocol	12 months	Slope: 0.7 to 1.3
Pressure/Depth	Only when required by user protocol	Only when required by user protocol	<2 times the full scale accuracy specification
Barometer	Only when required by user protocol	Only when required by user protocol	<2 times the full scale accuracy specification
Ammonium	Monthly	N/A	Slope > 20 mV/decade
Chloride	Monthly	N/A	Slope < -20 mV/decade
Nitrate	Monthly	N/A	Slope < -20 mV/decade

Chlorophyll a	Only when required by user protocol	12 months	
BGA-PC	Only when required by user protocol	12 months	
BGA-PE	Only when required by user protocol	12 months	
Rhodamine WT	Only when required by user protocol	12 months	
Fluorescein WT	Only when required by user protocol	12 months	
FDOM	Only when required by user protocol	12 months	
Crude Oil	Only when required by user protocol	12 months	

Factory Calibration

Factory calibration includes a thorough cleaning, full functionality check and sensor adjustments to all applicable sensors over the entire calibrated temperature range. We recommend a factory calibration every 12 months or when the unit appears to drift significantly.

Batch Calibrating Sensors in VuSitu

Different Sensor Types (Quick Cal Solution)



Use Quick Cal standard to calibrate conductivity, pH, and ORP with a single solution. Quick Cal solution can also be used for 100% RDO Saturation calibration. To calibrate multiple sensors of the same type, follow the instructions on the next page.

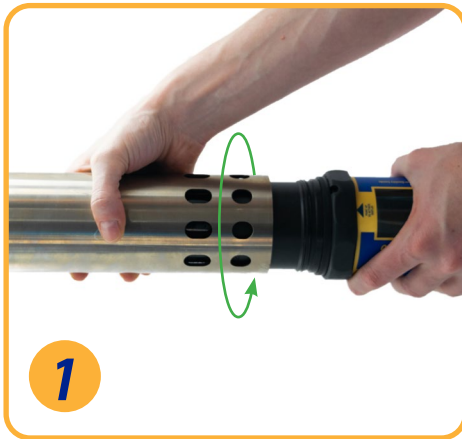

1
Install the restrictor in calibration mode (with holes closest to the instrument body).



2
In VuSitu, click **Calibrations** from the Connected Instrument screen. Choose **Quick Cal** from the menu.

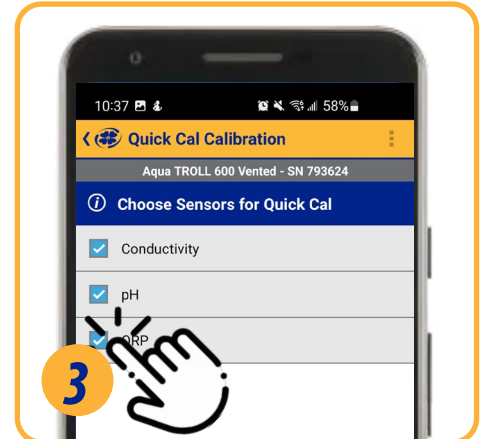

3
Select sensors to calibrate.



4
Set up the calibration. Make sure that all sensors are completely submerged.



5
When all sensors have stabilized, tap **Accept**. Review the calibration report for the completed sensors.



6
Flip the restrictor back into deployment mode and install the end cap.

Multiple Sensors of the Same Type



For some parameters (pH, ORP, RDO, turbidity, and conductivity), you can calibrate multiple sensors of the same type together. Use this feature when you need to batch calibrate a group of sensors prior to field deployment.



1 Install the sensors to calibrate. (pH/ORP sensors also require a temperature sensor.) Install the restrictor in calibration mode.



2 In VuSitu, click **Calibrations** from the Connected Instrument screen. Choose a calibration to perform.



3 Set up the calibration. Make sure that all sensors are completely submerged or in the same calibration environment.

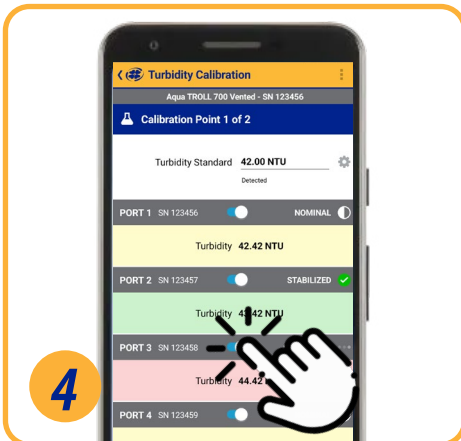

4 Wait for calibrations to complete. If one sensor isn't stabilizing, use the toggle switch to turn that sensor off and continue calibrating the others.

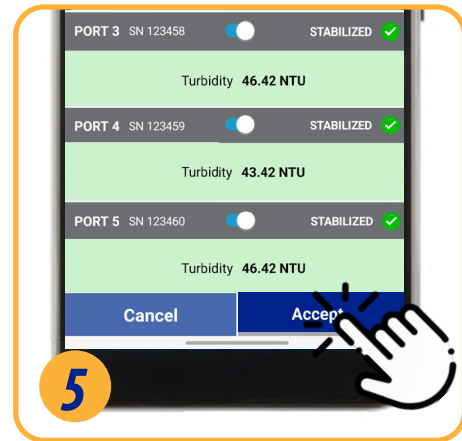

5 When all sensors have stabilized, tap **Accept**. Review the calibration report for the completed sensors.



6 Remove sensors and install them in the instruments they will be deployed in.

VuSitu Mobile App

VuSitu



Use VuSitu to calibrate, configure, and deploy your Aqua TROLL 800. Download the app for free from the Google Play Store or the Apple App Store.

Connecting with Bluetooth

The Aqua TROLL 800 can connect to a Bluetooth-enabled device for wireless communication with the VuSitu mobile app.

- If the Aqua TROLL 800 is connected to a Wireless TROLL Com, press the button on the Wireless TROLL Com. Then open VuSitu to connect.
- To connect to the Aqua TROLL 800 directly, turn on the Aqua TROLL 800 LCD screen by holding the sonde vertical with the sensor end facing up. Then open VuSitu to connect.

Connected Instrument Screen

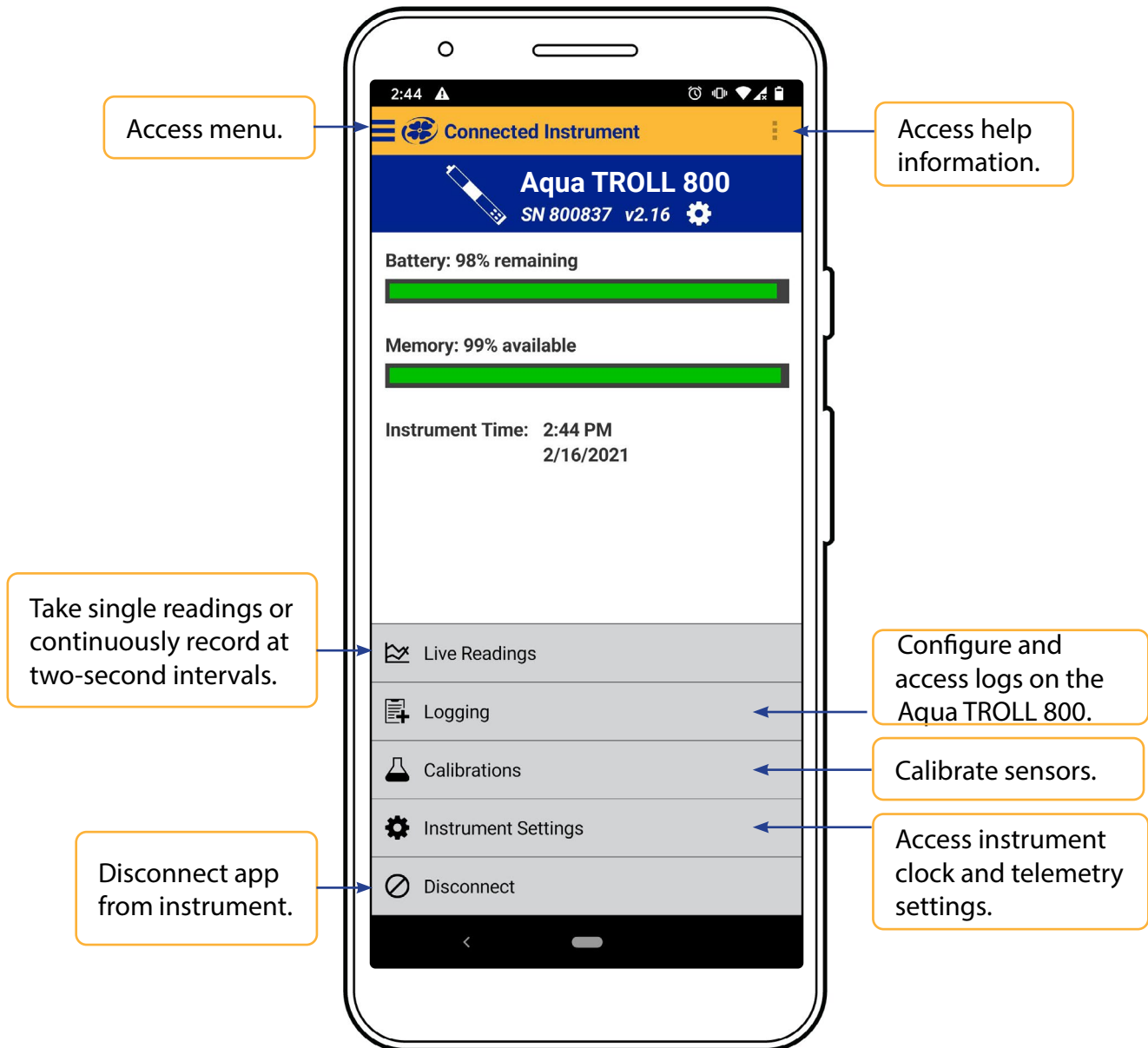

VuSitu Menu Options



The features available in the VuSitu mobile app vary slightly depending on the instrument to which it is connected.

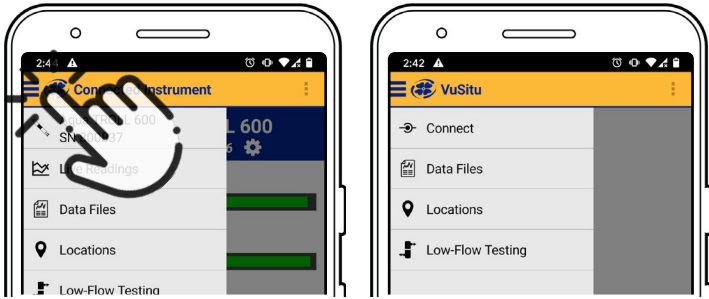

Tap the menu icon in the upper left portion of the screen to view options. Tap the icon again to close.

Some features aren't available when VuSitu isn't connected to an instrument.

Selecting with Long-press and Swipe

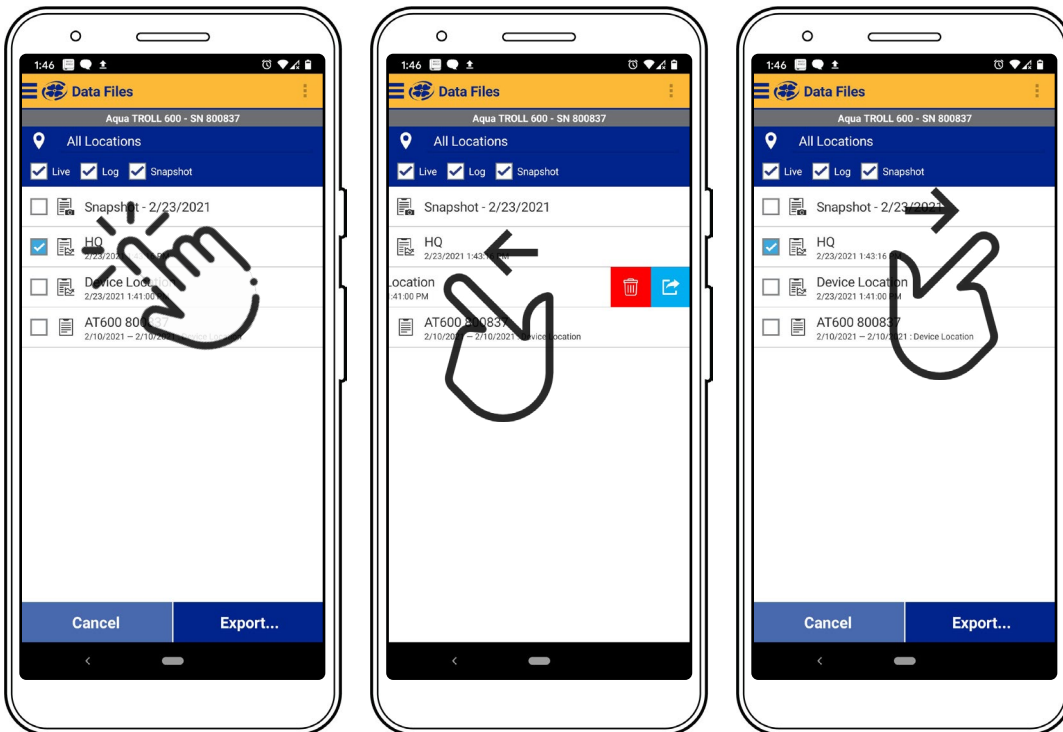

Press and hold any item in a list of files. You can now select multiple files.

Press and swipe left to reveal the delete and share icons.

Press and swipe right to reveal the sharing icon.

Live Readings in VuSitu



The live readings screen displays measurements taken from the instrument every two seconds. You can save these readings and share them via email or cloud storage.

Snapshot Mode

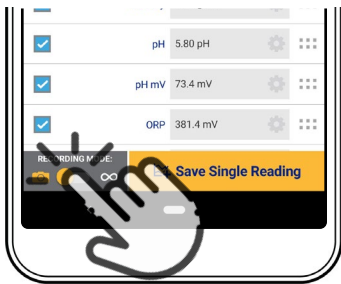

Tap the button on the bottom left to toggle between snapshot and live readings modes.

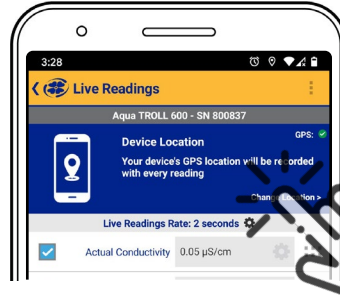

Tap **Change Location** in the top right corner if you wish to associate this data with a different location.

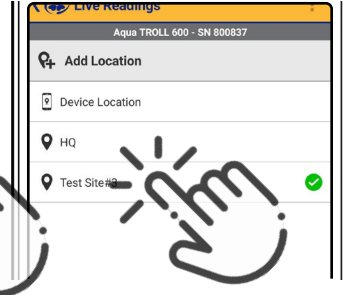

Choose the desired location and press **Save** in the bottom right corner of the screen.



Tap **Save Single Reading** to create a snapshot.

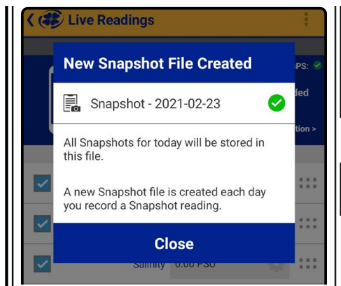

VuSitu confirms the new snapshot file.

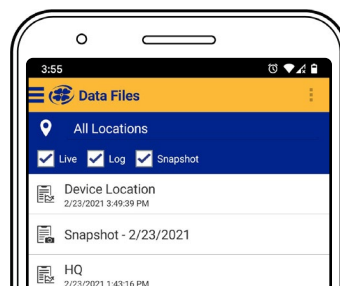

View the file from the Data Files screen.

Live Readings Mode

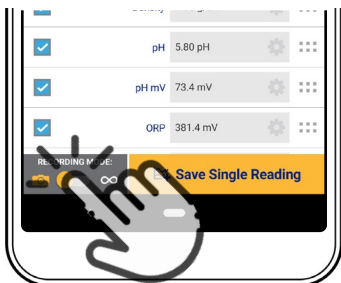

Tap the button on the bottom left to switch from snapshot mode to live readings mode.



Tap **Start Recording**. The instrument takes a reading every two seconds.



Tap **Stop** to end the recording. VuSitu displays a summary of the live readings data.

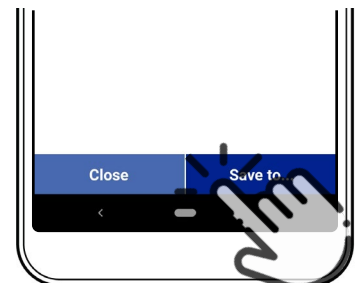

Tap **Save to** if you wish to share the Live Readings file via email or cloud storage.

Viewing and Sharing Data

Downloading Your Data



You can transfer a data file from your mobile device to a PC via Bluetooth, email it to yourself or any valid email address, or upload it to Google Drive.

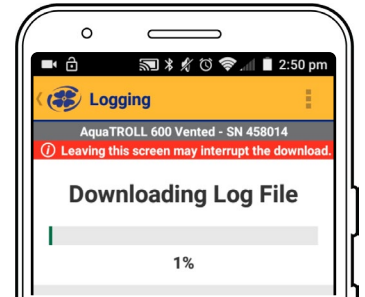
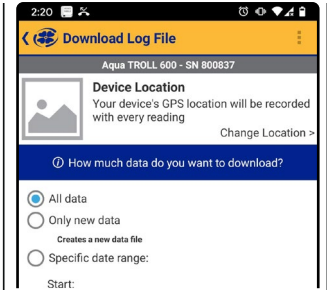
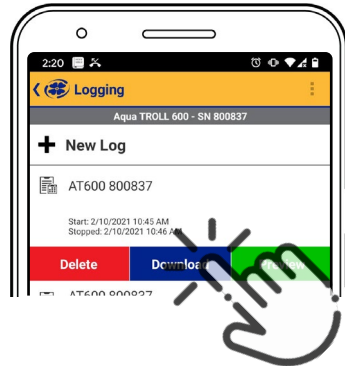
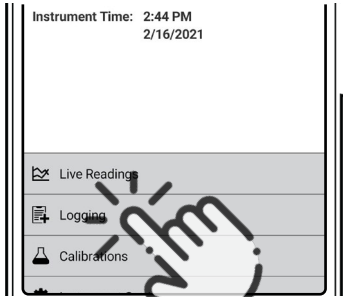

Pair VuSitu with the instrument. Select **Logging** from the Connected Instrument screen.

Tap a log and press the **Download** button.

Choose the data you wish to download. To save the entire log to your phone, choose **All data**.

VuSitu displays a progress bar while downloading.

Sharing Data

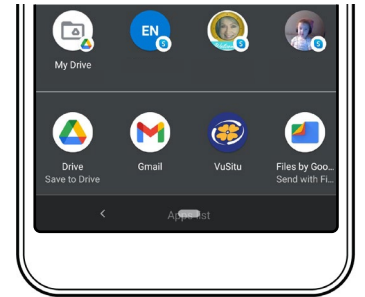
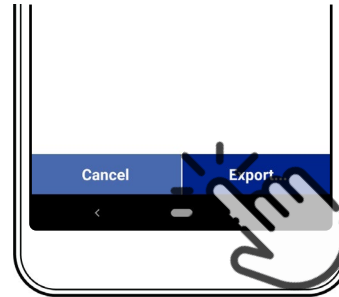
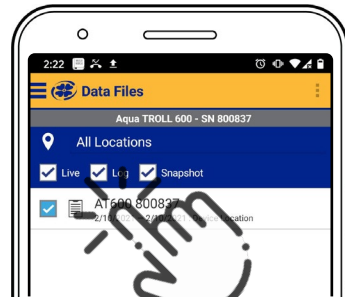
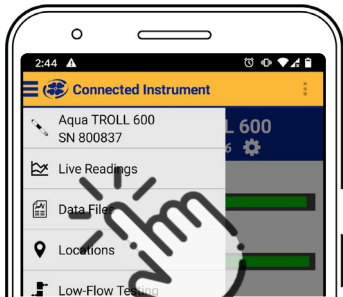

Select **Data Files** from the menu at the top left corner of the screen.

Tap and hold the name of the log you want to share.

Select **Export**.

Choose email, cloud storage, or another sharing option.



To save data locally on your mobile device, export to a third-party file management app.

Viewing Data on a Mac or PC



You'll need to extract your files to view them. To do that on a Mac, double-click the Zip folder. On a PC, right-click on the folder and choose **Extract**. Then open your files in Excel.

VuSitu Locations

About VuSitu Locations

A VuSitu location represents the physical spot where an instrument collects data. You can create a VuSitu location for any monitoring site. If you don't create a location, your data defaults to "Device Location." Location names appear on the live readings screen, in snapshot files, and in log files.

How to Create a Location

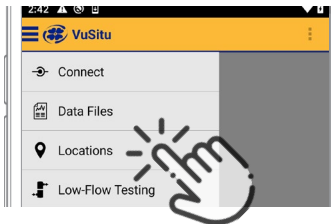

Select **Locations** from the main menu.

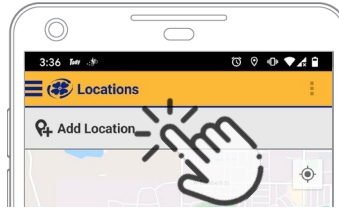

Tap **Add Location**.

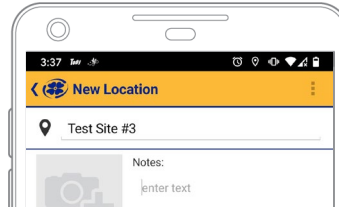

Enter a name for the location. You can also add notes.

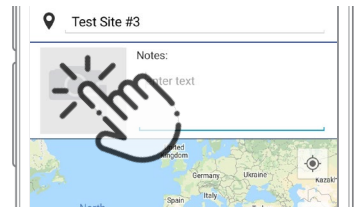

If desired, tap the camera icon to take a photo of the new location.

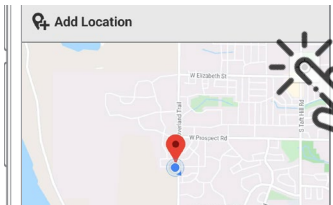

To home in on your mobile device's current location, tap the button on the top right.

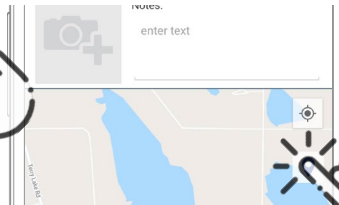

Tap the pin icon to establish the location on the map.



As an alternative, you can manually enter latitude and longitude values and tap **Apply**. Or, tap and hold a specific point on the map to drop a pin there.

How to Edit or Delete a Location

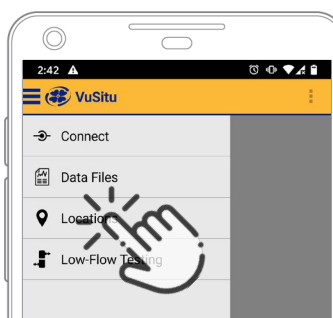

Select **Locations** from the app menu.

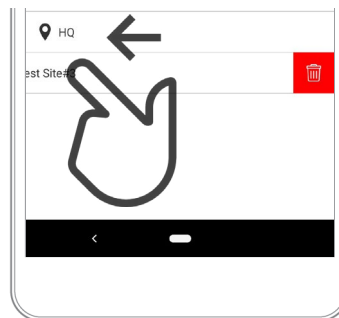

Tap the location you wish to delete and swipe left. Tap the trash icon.

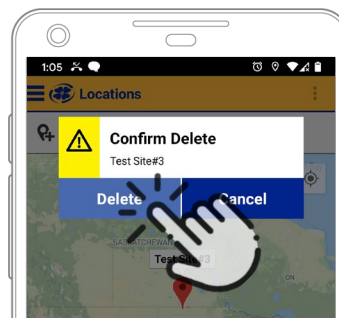

Confirm by tapping **Delete**.

How to Select a Location



Data is associated with the Location that is displayed on the Live readings screen. You can change the location for your data from the Live Readings screen.

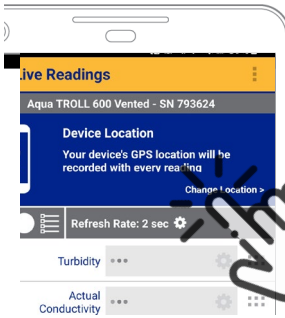

Tap **Change Location** on the live readings screen.

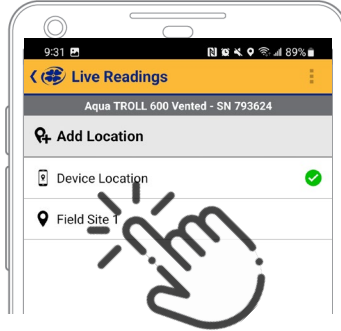

Tap a location to select it, or add a new Location.



Tap **Save**.

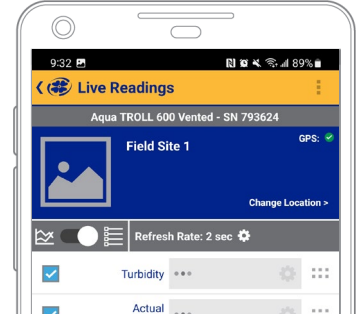

New live readings data will be associated with this location.

Instrument Bluetooth

Disabling Instrument Bluetooth



You can use Instrument Bluetooth to connect directly to the Aqua TROLL without a communication device. Instrument Bluetooth is enabled by default on your Aqua TROLL 800. If you need to disable Instrument Bluetooth, follow the steps below.



Connect to VuSitu using a Wireless TROLL Com or a VuLink.



Select **Instrument Settings**.

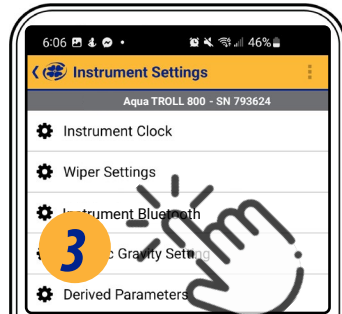

Select **Instrument Bluetooth**.

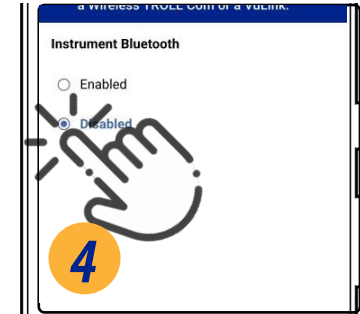

Choose **Disabled**, then save your selection.

Logging

Creating a Log with VuSitu



Connect to the instrument via VuSitu to create a log. Then follow the on-screen instructions. You can schedule a start time for the log or start the log immediately.

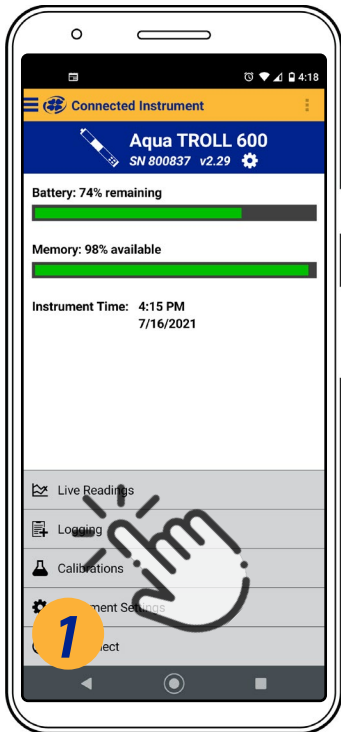

Select **Logging**.

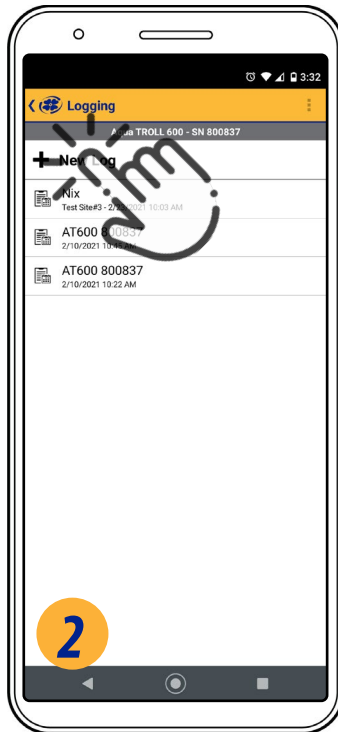

Tap **New Log**.

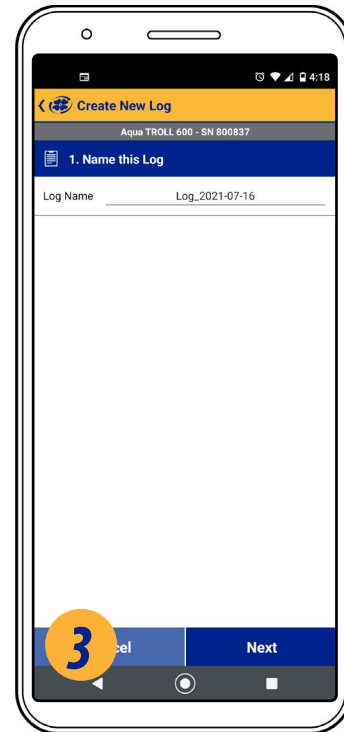

Follow the on-screen instructions to create and schedule a log.



For non-vented instruments, program a VuLink log with barometric compensation enabled. View the compensated data in HydroVu or download the log from the VuLink. See the Remote Monitoring section of this manual for more information.

Remote Monitoring with VuLink



Using VuLink in any manner not specified by the manufacturer may impair the device's built-in protections. For complete information on remote monitoring, refer to the VuLink manual at www.in-situ.com

1 Claim VuLink.

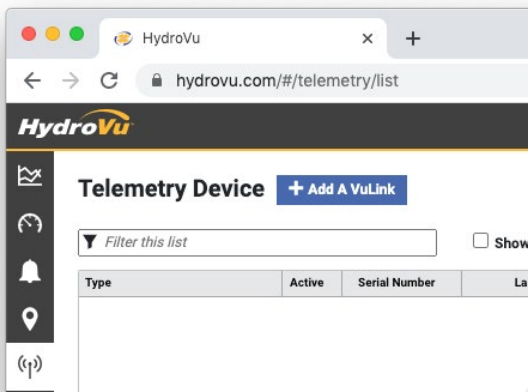

Log into your HydroVu account and claim VuLink from the Telemetry page.

3 Configure and deploy.

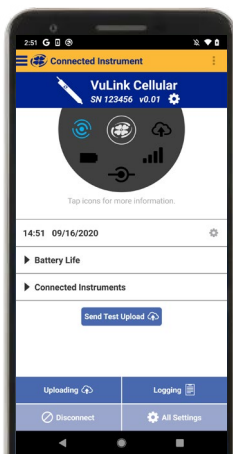

Create a log and adjust instrument settings with the VuSitu mobile app. Then deploy the instrument.

2 Connect the instrument.

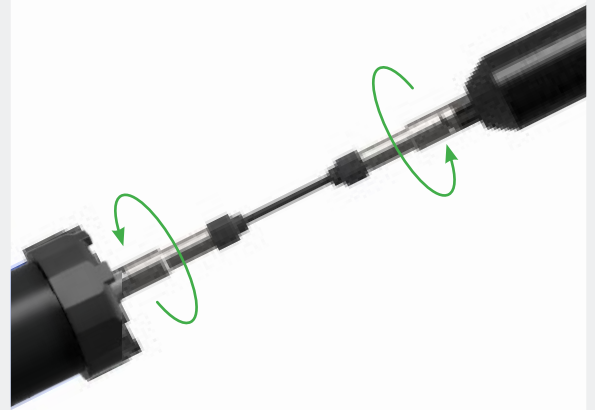

Connect the Aqua TROLL instrument to VuLink with a Rugged Twist-Lock Cable.

4 View data in HydroVu.

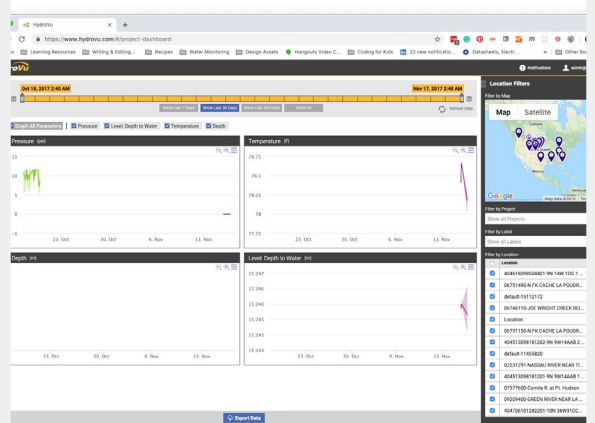

See graphs of your data and make changes to VuLink in HydroVu.



Barometric Compensation of Non-Vented Instruments

Non-vented instruments log absolute pressure readings by default. You can use the built-in barometer in a VuLink to automatically compensate the pressure and level readings. To turn on barometric compensation with a VuLink, follow the steps below. To turn off barometric compensation, factory reset the Aqua TROLL.

1 Configure the VuLink Log

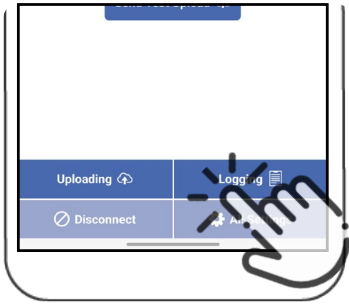

Open VuSitu and connect to the VuLink. Tap **Logging**.



Tap **New Log**.

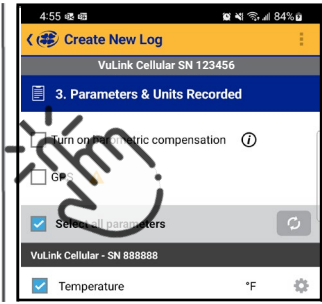

Configure the VuLink Log. Check **Turn on Barometric Compensation** when prompted.

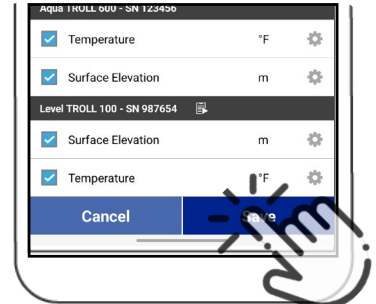

Save the VuLink Log.

2 Configure the Instrument Log

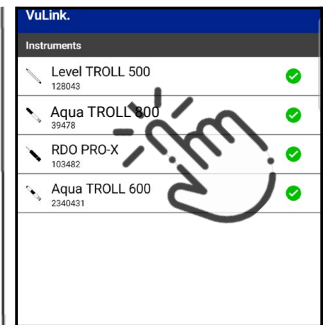

Select your Aqua TROLL 800 under **Connected Instruments**.



Follow the instructions in the Logging section of this manual to create a log on the Aqua TROLL.

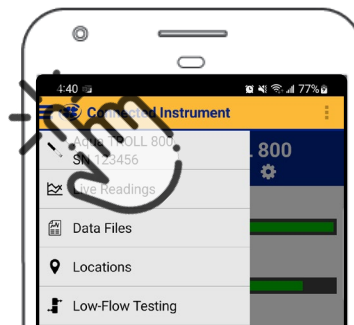

Use the menu to return to the VuLink if you need to configure additional settings.



For the most accurate readings on the Aqua TROLL log, use a similar start time and reading rate for both logs. The VuLink log will collect a new barometric pressure value with every reading. The Aqua TROLL Log will use the most recent barometric pressure provided by the VuLink.

HydroVu



HydroVu is a data-management application that runs in the browser. Use it to manage data, view graphs, and configure telemetry devices for remote monitoring. See it at www.hydrovu.com.

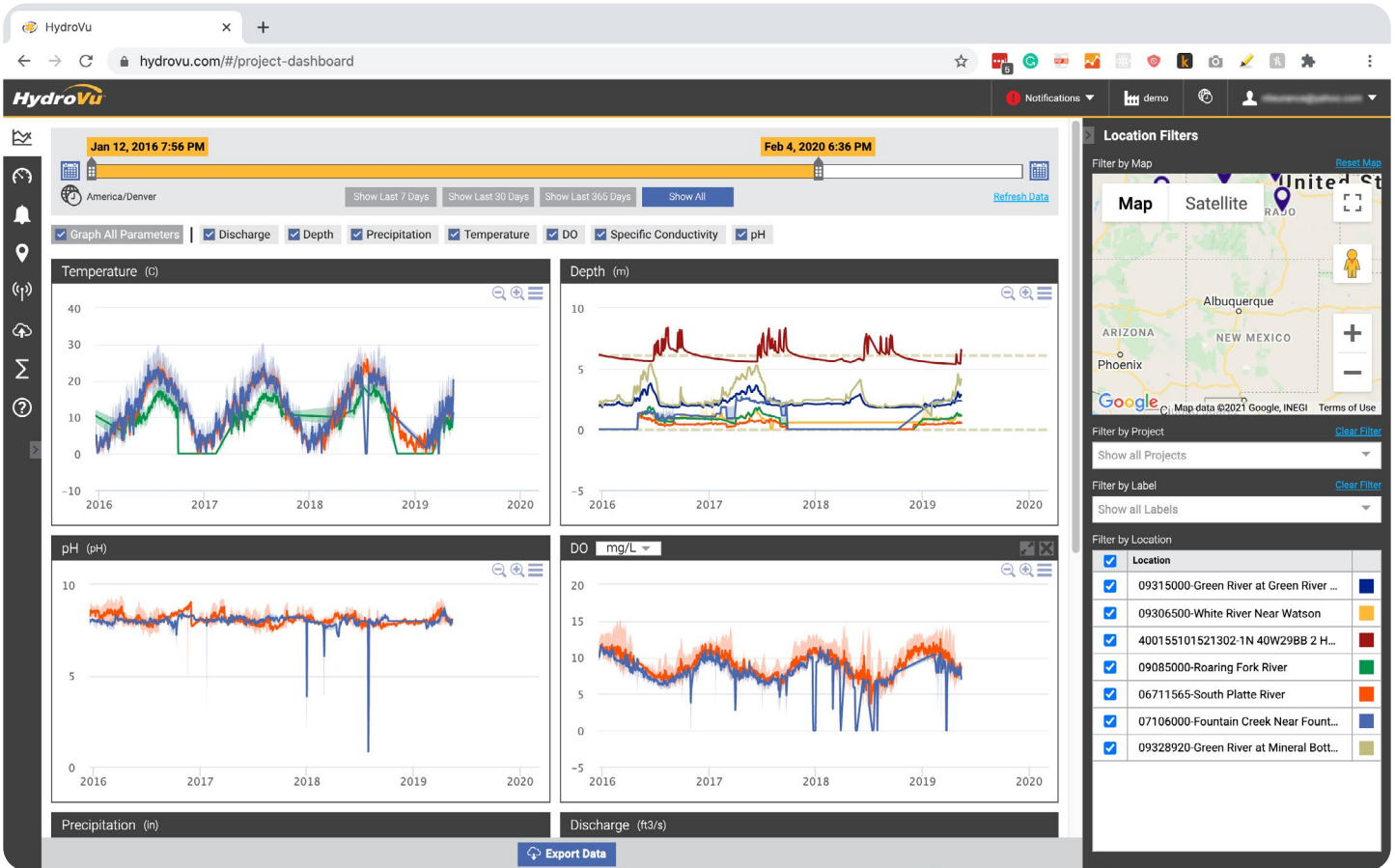

Connecting the Aqua TROLL 800 to a PLC or Data Logger

Flying Leads Wire Diagram



Refer to the diagrams on the following pages for PLC wiring diagrams. Unused leads should not be touching.

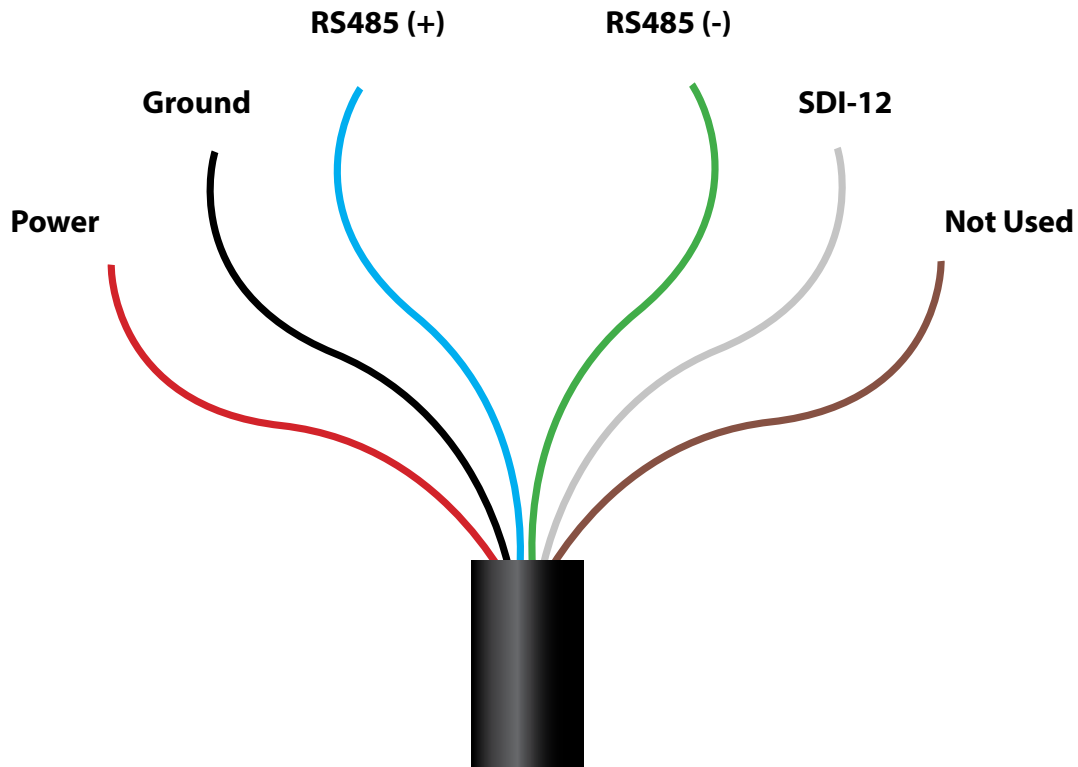

Flying Leads Cable Wire Legend

Wire Color	Signal
Red	External Power
Black	Ground
Blue	RS485 (+)
Green	RS485 (-)
White	SDI-12
Brown	Not Used

SDI-12 3 Wire

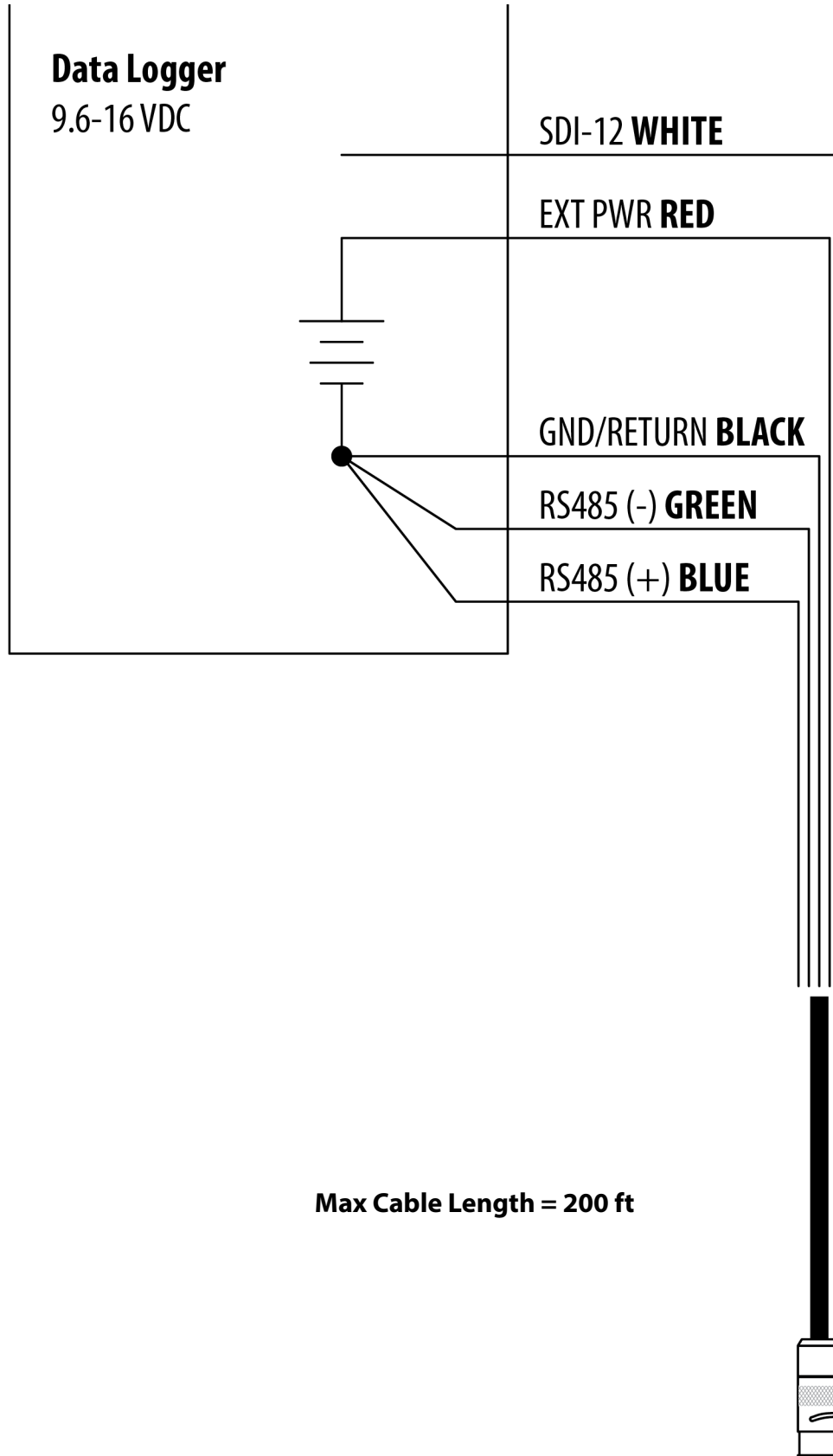

Modbus Master RS485

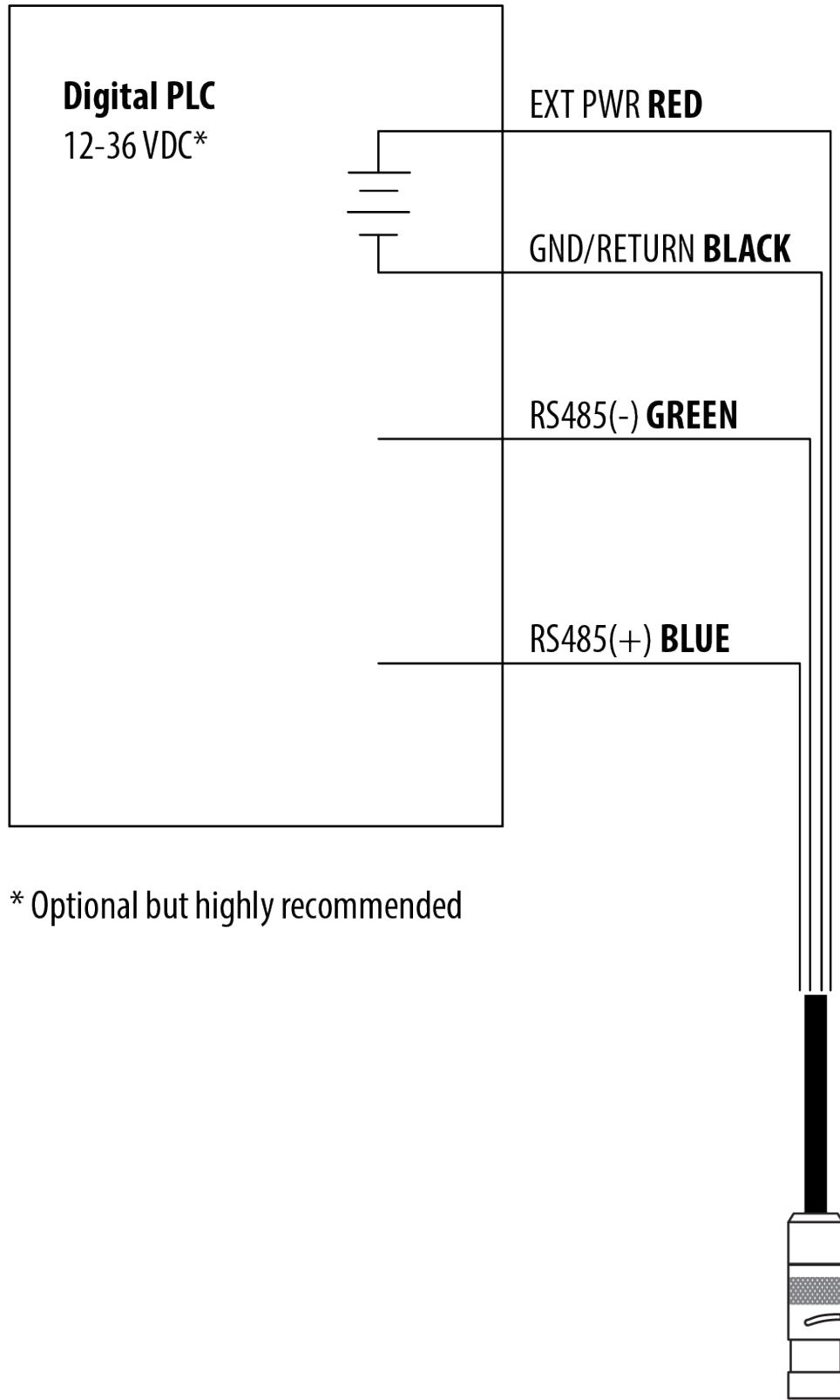

Modbus Master with RS232 (Converter Required)

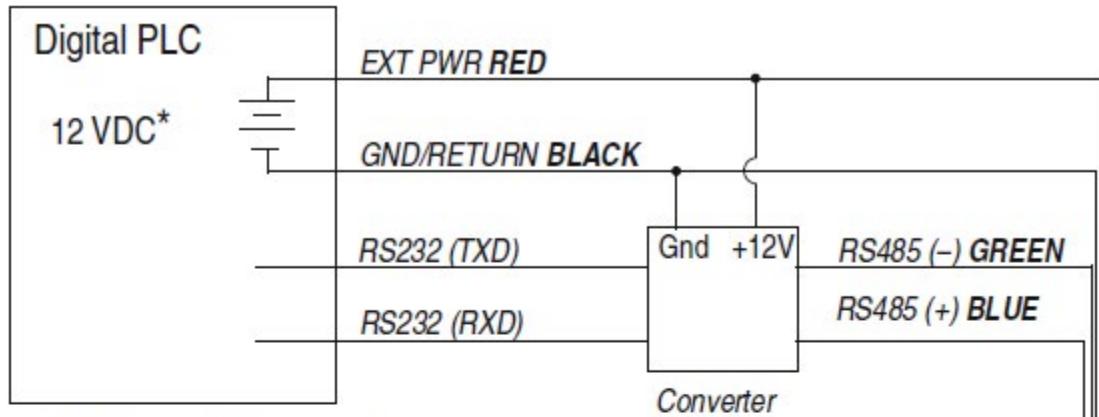

* Voltage limited by converter

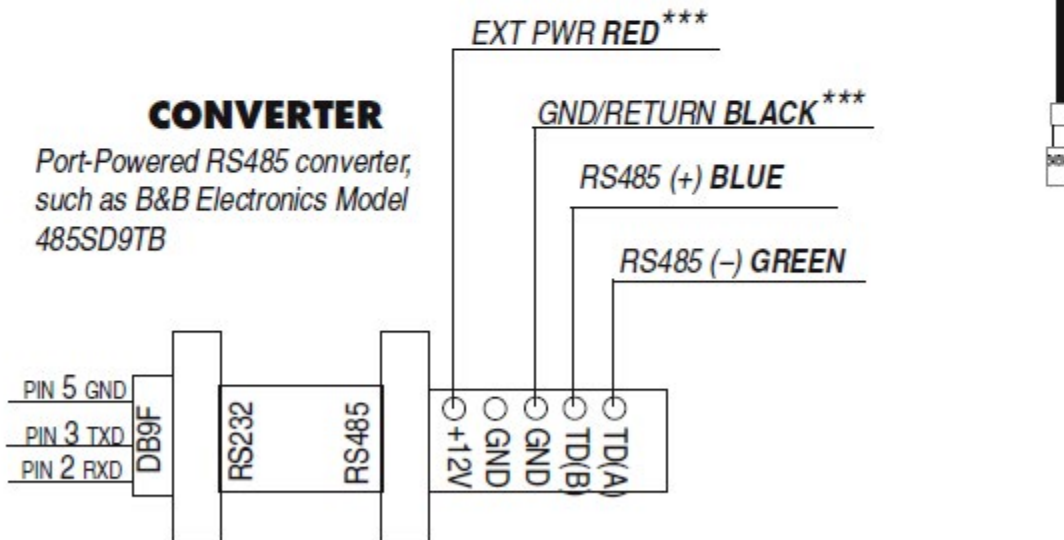

***Required if port power is not available

Configuring SDI-12 Settings

About SDI-12

You can configure the list of SDI-12 parameters in VuSitu under **Instrument Settings**.

The Aqua TROLL 800 conforms to the general SDI-12 Standard Version 1.3. For more information about SDI-12 commands, see the SDI-12 Standard Version 1.3 document from the SDI-12 Support Group Technical Committee.

Configure SDI-12 Settings in VuSitu

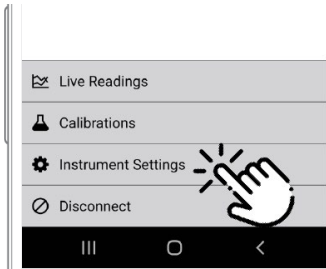

Connect to VuSitu and select **Instrument Settings**.

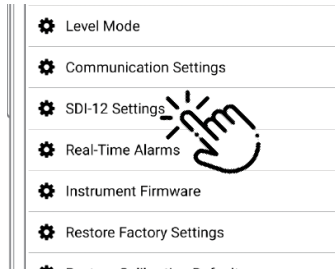

Choose **SDI-12 Settings**.

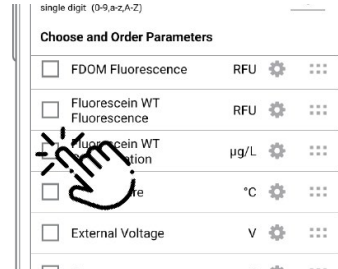

Use the checkboxes to select parameters to display.

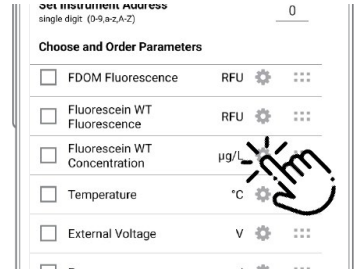

Tap the gear icon to adjust the units for each parameter.

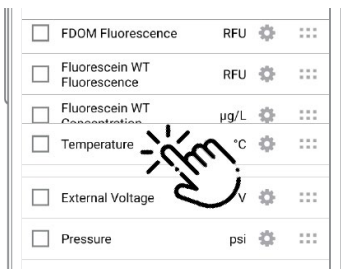

Drag and drop parameters to change the order.

Modbus PLC Interface

Overview

The Modbus PLC Interface is a simplified method of communicating with the Aqua TROLL 800 using the Modbus protocol. It reduces programming complexity and allows the user to remove sensors and reinstall them in different ports. Please note the following limitations when using this interface:

- Only one sensor of any sensor model can be used in the sonde (for example: only one turbidity sensor can be installed).
- If a parameter is provided by more than one of the installed sensors, the interface will return the most accurate value available.

For information about the specific Modbus registers and Unit IDs for your Aqua TROLL 800, see Appendices A and B. The Aqua TROLL 800 conforms to the Modbus standard. For more information about Modbus communication, see www.modbus.org.

Setting Up Instrument

1. Install the sensors, connect power, and turn on the display by holding the instrument vertically.
 - a. Ensure the display turns on and check the LCD to ensure the sensors are working.
2. The setup below is using the instrument's factory default settings. Use VuSitu to reset the instrument to factory defaults if they have been changed. Take note of any changes in default units setup.

Programming the PLC

1. Set up the serial communication to match the instrument communication settings. Communication settings can be changed with the VuSitu mobile app. The default communication settings are:

Mode	Start Bit	Baud Rate	Data Bits	Parity	Stop Bit
RTU	1	19200	8	Even	1

2. Set the device address match the instrument address. The default device address is 1.
3. Set the PLC to wake-up the device by sending a carriage return (0x0D) or any Modbus command.
 - a. Allow one second before sending a second command. The instrument needs this time to wake up.
 - b. After the wake-up command, the next reading must be taken before the end of session timeout. If the reading interval exceeds the end of session timeout, send a new wake-up command before requesting a new reading. The default end of session timeout is 5 seconds, and may be longer if the instrument has been connected to VuSitu.
4. If you have changed or moved the sensors since the device was last connected, read holding register 6948 to trigger the instrument to scan the sensors. The return value can be discarded.
 - a. Each register is a holding register. Some PLCs require you to add 40000 to the register number or address. For example: 6948 would be 46948.
 - b. Alternatively, you can prompt the instrument to discover its sensor mapping by connecting it to the VuSitu mobile app.
5. Select the register to read on the PLC using the information in the following sections.
 - a. Some PLC devices use the register number directly in programming statements, others use register addresses, which are one less than the register number. Refer to PLC manufacturer instructions to determine which programming style to use.
 - b. Each register is a holding register. Some PLCs require you to add 40000 to the register number or address. For example: 5451 would be 45451.
6. Set the type of register to: 32-bit float
 - a. If asked by the PLC this is 2 registers
7. Set the byte order to: Big Endian (MSB)
 - a. This should be the default and may not be configurable on all PLCs

Reading Device Information

Use the following registers to read general information about the instrument.

Holding Register Number	Holding Register Address	Size (Registers)	Data Type	Description
9001	9000	1	uint16	Device Id: 40 = Aqua TROLL 800 Non-vented 41 = Aqua TROLL 800 Vented
9002	9001	2	uint32	Serial Number
9007	9006	1	uint16	Firmware version (100 = 1.00)

Reading Parameters

Each parameter contains a block of 7 registers as shown in the table below. To read measurements for a specific parameter, look up the starting register for that parameter from the list of Parameter Numbers and Locations in Appendix A. Once you have the starting register, add the number of offset registers for additional information about the reading.

Register Offset	Size (Registers)	Mode (R/W)	Data Type	Description
0	2	R	float	The measured value from sensor
2	1	R	uint16	Data Quality ID: 0 = No errors or warnings 3 = Error reading parameter 5 = RDO Cap expired For additional errors or information, contact technical support.
3	1	R/W	uint16	Units ID for this parameter. See: Appendix B.
4	1	R	uint16	Parameter ID for this parameter. See: Appendix A.
5	2	R/W	float	Off line sentinel value: The value that's returned on error or if the parameter isn't available. The default sentinel is 0.0

For example, you can apply this information to collect a reading for Actual Conductivity.

From the list in Appendix A, you can find that the starting register for Actual Conductivity is 5507. A reading from register number 5507 (register address 5506) will return the measured value of Actual Conductivity.

Some PLC devices use the register number directly in programming statements, others use register addresses. Refer to PLC manufacturer instructions to determine which programming style to use.

You can use the register offsets listed in the table above to collect additional information about the reading. Adding the register offset of 2 to the starting register, you can find that register number 5509 (register address 5508) will return the Data Quality ID for the most recent Actual Conductivity measurement. Likewise, register number 5510 (register address 5509) will return the Units ID, which can be interpreted from Appendix B. Register number 5511 (register address 5510) will return the Parameter ID, which can be interpreted from Appendix A. Register number 5512 (register address 5511) will return the sentinel value.

The Units ID and Sentinel Value are writeable registers. Measurements can be changed to other units using the Units ID as shown in Appendix B. For example, if register number 5510 (Actual Conductivity Units ID) returns 65, Actual Conductivity is configured to report in $\mu\text{S}/\text{cm}$. Looking at Appendix B, you can find that mS/cm is also a valid unit which can be set by writing Units ID 66 to register number 5510.

Turning on Instrument Bluetooth with a PLC

Use the VuSitu mobile app to configure, calibrate, and troubleshoot the instrument. Wait 1 minute after the last command before connecting to VuSitu. To enable Bluetooth without a communication device:

1. Stop sending logging or data commands from the PLC or data logger.
2. Write "1" to register number 9211 (register address 9210) to enable Instrument Bluetooth.
3. Set the instrument on a flat surface and stop sending commands for 1 minute.
4. Turn instrument vertical to activate the changes, then connect to VuSitu.

Care and Maintenance

Storage

Short-term (less than one week)



Remove the restrictor and the end cap.



Put the restrictor on the instrument in calibration mode.



Pour 15 mL (0.5 oz) of clean water into the restrictor.



Thread the cap onto the sonde and store.

Long-term (more than one week)



Remove pH/ORP sensor and any ISE sensors.



Dampen the sponge inside the pH/ISE sensor storage caps with Storage Solution or pH 4 calibration standard.



Replace the caps at both ends of the sensor. Use electrical tape to seal the storage cap.



Thread the restrictor onto the sonde.



Store the sonde between -40 and 65° C. See the Instrument Specifications section for additional storage temperature requirements for pH/ORP and ISE sensors.

Cleaning the Sonde

Rinse the sonde thoroughly. Clean with warm water and mild soap, then rinse the sonde again. Allow to air dry.



Prevent water from entering the cable connector.

Removing the Restrictor

If the restrictor or end cap are stuck and difficult to remove by hand, use strap wrenches to provide extra leverage. Remove the end cap bumper before using strap wrenches.



Never use pipe wrenches or a vise grip which may damage the instrument. Never insert tools into the restrictor holes for leverage, as they may damage the wiper shaft or sensors. Strap wrenches should only be used when necessary to remove or loosen parts. Tighten parts by hand only.

Maintenance Schedule



For best results, send the instrument and sensors for factory maintenance and calibration every 12 to 18 months.

User-Serviceable Parts



O-rings

Lubricate O-rings during initial setup. Check and replace O-rings if worn, damaged, or discolored.



Wiper Brush

Replace brush according to site needs when bristles are visibly bent, damaged, or fouled.



Desiccant Capsule

Replace the desiccant capsule when the desiccant turns pink.



Bumpers

Replace bumpers and collar when they are visibly worn or damaged.



Sensors

See each sensor instruction sheets for details about maintaining and replacing each sensor.

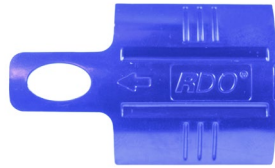

RDO Sensor Cap

Refer to the sensor cap instruction sheet for details.



Sensor Fill Solution

Refer to the instructions for the pH/ORP sensor and ISE sensors like Nitrate, Ammonium, and Chloride for details.



Reference Junction

Refer to the instructions for the pH/ORP sensor and ISE sensors like Nitrate, Ammonium, and Chloride for details.

Wiper Maintenance



Replace brush according to site needs when bristles are visibly bent, damaged, or fouled.

Replace wiper brush.



Loosen brush housing with hex key.

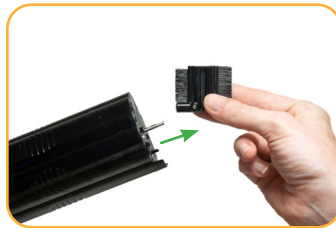

Slide the old brush off of the wiper shaft.



Slide the new brush onto the wiper shaft.



Tighten brush screw with hex key.

Replacing Desiccant

A replaceable desiccant capsule prevents moisture from damaging the instrument and batteries. Check the capsule periodically. A pink color indicates expired/exhausted desiccant.



Remove the battery cover.



Remove the wrench from the back of the battery compartment.

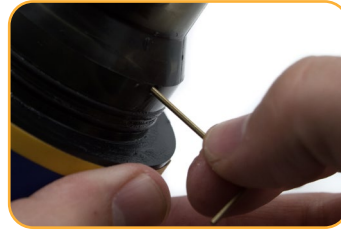

Use the wrench to push the desiccant capsule out of the hole in the back of the battery compartment.



Insert a new capsule. Replace the wrench and battery cover.

Replacing O-Rings



Replace O-rings when performing routine maintenance. Refer to the diagram below for the location of each O-ring. Apply a thin layer of grease to each O-ring after installing.



1. Twist-Lock O-Ring
2. Battery Cover Connector O-Rings
3. Battery Cover O-Rings
4. Restrictor Seal O-Rings
5. Sensor Block O-Ring
6. Sensor Connector O-Rings
7. RDO® Cap O-Rings (RDO sensor only)



Never use metal objects to remove O-rings. They can scratch the plastic and compromise the quality of the seal. If necessary, wood or plastic tools may be used to gently remove O-rings.

Cleaning and Storing the pH/ORP Sensor and Ion-Selective Electrode (ISE) sensors

Storage



Dampen the sponge inside the sensor storage cap with Storage Solution or pH 4 calibration standard.



Replace the caps at both ends of the sensor. Use electrical tape to seal the storage cap.



Do not store the pH/ORP sensor or ISE sensors in DI water. It will deplete the reference solution and drastically reduce the life of the sensor.

Routine Maintenance

If the ORP platinum electrode is dull or dirty, it can be cleaned with a swab and methanol or isopropyl alcohol. Rub the electrode gently until it is shiny. The pH sensor must be kept moist for the life of the sensor. The sensor fill solution has a shelf life of 2 years. Replace the fill solution every 5 to 6 months or when:

1. The sensor fails to calibrate within the acceptable slope and offset range.
2. Sensor readings vary or are slow to respond.
3. Readings during calibration at pH 7 are greater than +30 mV or less than -30 mV.

Replacing the Filling Solution



Remove sensor from sonde and unscrew reference junction.



Discard old solution onto a paper towel and throw it in the trash. Do not discard down the drain.



Insert tube from filling solution bottle into sensor.



Squeeze solution into reservoir until full. Slowly remove tube.



Reinstall reference junction. Dry sensor body.

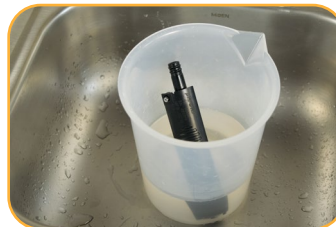

Soak ISE sensors for 2 hours in the highest concentration calibration standard you plan to use.



Rinse the sensor thoroughly prior to calibration.

Replacing the Junction



If the sensor fails to calibrate after you replace the fill solution, replace the reference junction.



Remove sensor from sonde and unscrew reference junction.



Discard old solution onto a paper towel and throw it in the trash. Do not discard down the drain.



Insert tube from filling solution bottle into sensor.



Squeeze solution into reservoir until full. Slowly remove tube.



Reinstall reference junction and wipe sensor body dry.



Soak ISE sensors for 2 hours in the highest concentration calibration standard you plan to use.



Rinse the sensor thoroughly prior to calibration.



Keep the reference junction damp at all times.

Cleaning

Begin with the gentlest cleaning method and continue to the others only if necessary. Do not directly wipe the glass bulb. To clean the pH sensor, gently rinse with cold water. If further cleaning is required, consider the nature of the debris.

To remove crystalline deposits:

1. Clean the sensor with warm water and mild soap.
2. Soak the sensor in 5% HCl solution for 10 to 30 minutes.
3. If deposits persist, alternate soaking in 5% HCl and 5% NaOH solutions.

To remove oily or greasy residue:

1. Clean the sensor with warm water and mild soap.
2. Methanol or isopropyl alcohol may be used for short soaking periods, up to 1 hour.
3. Do not soak the sensor in strong solvents, such as chlorinated solvents, ethers, or ketones, such as acetone.

To remove protein-like material, or slimy film:

1. Clean the sensor with warm water and mild soap.
2. Soak the sensor in 0.1 M HCl solution for 10 minutes and then rinse with deionized water.

Cleaning and Storing the RDO Sensor

Routine Maintenance

1. Leave the sensor cap on.
2. Rinse the sensor with clean water.
3. Gently wipe with a soft cloth or brush if biofouling is present.
4. If extensive fouling or mineral buildup is present, soak the sensor in vinegar for 15 minutes, then soak in deionized water for 15 minutes.



Do not use organic solvents—they will damage the sensor cap. Do not remove the sensor cap when rinsing or brushing.

5. After cleaning the sensor, perform a 100% Saturation Calibration.

Cleaning the Optical Window

Clean the optical window only when changing the sensor cap.

1. Remove the cap.
2. Gently wipe the sensing window with the supplied lens cloth.



Do not wet the lens with any liquid.

Storage

Prior to installation, store the sensor body and cap in the factory supplied containers.

Once installed on the sonde, the RDO sensor can be stored wet or dry depending on the sensor configuration of the sonde.



Never store the RDO sensor without the sensor cap once it has been installed on the sonde.

Cleaning and Storing the Turbidity Sensor

Routine Maintenance

The optical windows should be clear of foreign material. To clear material gently rub the sensing windows using clean water and a soft cloth or swab. Do not use solvents on the sensor.

Storage

Prior to installation, store the sensor in the factory supplied container. Once installed on the sonde, the turbidity sensor can be stored wet or dry depending on the sensor configuration of the sonde.

Cleaning and Storing the Conductivity Sensor



Soaking the sensor in vinegar for longer than one hour can cause serious damage.

Begin with the most gentle cleaning method and continue to the other methods only if necessary. To clean the conductivity sensor face, gently rinse with clean, cold water. If further cleaning is required, consider the nature of the debris.

To remove crystalline deposits:

1. Clean the sensor face with warm water and mild soap.
2. Use a soft brush to gently clean the sensor pins and temperature button. Ensure removal of all debris around the base of the pins and button.
3. If crystalline deposits persist, soak in 5% HCl for 10 to 30 minutes followed by warm soapy water and soft brushing.
4. If deposits persist, alternate soaking in 5% HCl and 5% NaOH solutions followed by warm soapy water and soft brushing.

To remove oily or greasy residue:

1. Clean the sensor face with warm water and mild soap.
2. Using a soft brush, gently clean the sensor pins and temperature button. Ensure removal of all residue around the base of the pins and temperature button.
3. Isopropyl alcohol may be used for short soaking periods, up to one hour.
4. Do not soak in strong solvents such as chlorinated solvents, ethers or ketones (such as acetone).

To remove protein-like material, or slimy film:

1. Clean the sensor face with warm water and mild soap.
2. Using a soft brush, gently clean the sensor pins and temperature button. Ensure removal of all material/film around the base of the pins and temperature button.
3. Soak the sensor in 0.10% HCl for 10 minutes and then rinse thoroughly with distilled water.

Storage

Prior to installation, store the sensor in the factory supplied container.

Once installed on the sonde, the Temperature Sensor and Conductivity Sensor can be stored wet or dry depending on the sensor configuration of the sonde.

Cleaning the Copper Antifouling Restrictor

When copper is deployed in environmental waters, particularly marine environments, the copper will oxidize and develop a patina, which may affect optical sensor readings. Avoid soaking the restrictor in solvents or acids so that the natural patina is preserved and calibrations are representative of field conditions.

1. Remove the restrictor from the sonde.
2. Remove the restrictor end cap.
3. Gently remove biofilm with a cloth or soft bristle brush, mild soap, and warm water.
4. Rinse the restrictor in water and air dry.

Service and Repair

Obtaining Repair Service

If you suspect your system is malfunctioning and repair is needed, you can help assure efficient servicing by following these guidelines:

1. Call or email In-Situ Technical Support. Have the product model and serial number available.
2. Be prepared to describe the problem, including how the product was used and the conditions noted at the time of the malfunction.
3. If Technical Support determines that service is needed, they will ask your company to fill out the RMA form and pre-approve a specified monetary amount for repair charges. When the form and pre-approval is received, Technical Support will assign an RMA (Return Material Authorization) number.
4. Clean the product as described in the manual.
5. If the product contains a removable battery, remove and retain it unless you are returning the system for a refund or Technical Support states otherwise.
6. Carefully pack your product in its original shipping box, if possible.
7. Mark the RMA number clearly on the outside of the box.
8. Send the package, shipping prepaid, to:

In-Situ:

ATTN: Repairs

221 East Lincoln Avenue

Fort Collins, CO 80524

The warranty does not cover damage during transit. In-Situ recommends insurance for all shipments. Warranty repairs will be shipped back prepaid.

Outside the U.S.

Contact your international In-Situ distributor for repair and service information.

Guidelines for Cleaning Returned Equipment

Please help us protect the health and safety of our employees by cleaning and decontaminating equipment that has been subjected to potential biological or health hazards, and labeling such equipment. Unfortunately, we cannot service your equipment without such notification. Please complete and sign the form (or a similar statement certifying that the equipment has been cleaned and decontaminated) and send it to us with each instrument.

1. We recommend cleaning with only mild soaps that are compatible with the product materials. Wetted materials lists are provided on the product specification sheets. Clean all cables and remove all foreign matter.
2. Clean the cable connectors with a clean, dry cloth. Do not submerge the connectors.
3. Clean the instrument including the restrictor, sensor faces, and sonde body.



If an instrument is returned to our Service Center for repair or recalibration without a statement that it has been cleaned and decontaminated, or if it is the opinion of our Service Representatives that the equipment presents a potential health or biological hazard, we reserve the right to withhold service until proper certification is obtained.

Decontamination & Cleaning Statement



Company Name	Phone
Address	
City	State
Instrument Type	Serial Number
Contaminant(s) if known	
Decontamination procedure(s) used	
Cleaning verified by	Title
Date	

More Information



To learn more about the Aqua TROLL 800, telemetry, software and other In-Situ products, see the resources listed below.

1 Visit www.in-situ.com

Find information about In-Situ water quality, water level, telemetry and other products. Download software, manuals and product instructions.

2 View the *In-Situ YouTube channel*.

Get video instructions for the Aqua TROLL 800 and other instruments. Watch Quick Start videos and other tutorials.

3 Call *In-Situ's technical support team*.

For further instructions and help with technical questions, call the In-Situ support line at 1-970-498-1500.

Declaration of Conformity



In-Situ

Innovations in Water Monitoring

CE Declaration of Conformity

Manufacturer: In-Situ, Inc.
221 East Lincoln Avenue, Fort Collins, CO 80524, USA

Declares that the following product:

Product name: **Aqua TROLL 800**

Model: **Aqua TROLL 800**

Product Description: Multiparameter sonde for measuring water quality

Model Variants: No Pressure, Non-Vented and Vented variants. Sondes with pressure have variants based on pressure ranges the instrument was calibrated for (for example: 0-9m, 0-30m, etc.)

is in compliance with the following Directive

- 2014/30/EU EMC Directive
- Restriction of the use of certain hazardous substances in electrical and electronic equipment (RoHS) Directive, 2011/65/EU and Commission Delegated Directive, (EU) 2015/863

and meets or exceeds the following international requirements and compliance standards:

EMC Standards:

EN 61326-1:2021

RoHS Standard:

EN 63000:2018

The CE mark is affixed accordingly.

David A. Bossie
Regulatory Compliance Manager
In-Situ, Inc.
April 24, 2023



WWW.IN-SITU.COM

221 East Lincoln Avenue, Fort Collins, CO 80524 USA

Toll Free: 800.446.7488 Tel: 970.498.1500 Fax: 970.498.1598

Copyright © 2015 In-Situ Inc. This document is confidential and is the property of In-Situ Inc. Do not distribute without approval.



UKCA Declaration of Conformity

Manufacturer: In-Situ, Inc.
221 East Lincoln Avenue, Fort Collins, CO 80524, USA

We declare that the performance of the following product:

Product name: Aqua TROLL 800

Model: Aqua TROLL 800

Product Description: Multiparameter sonde for measuring water quality.

Model Variants: No Pressure, Non-Vented and Vented variants. Sondes with pressure have variants based on pressure ranges the instrument was calibrated for (for example: 0-9m, 0-30m, etc.)

is in compliance with the following Regulations:

- EMC Regulation 2016
- Restriction of the use of certain hazardous substances in electrical and electronic equipment (RoHS) Regulation (S.I. 2012:3032)

and meets or exceeds the following British requirements and compliance standards:

- **EMC:** BS 61326-1:2021
- **RoHS:** BS 63000:2018

The UKCA mark is affixed accordingly.

David A. Bossie
Regulatory Compliance Manager
In-Situ, Inc.
April 24, 2023



Appendix

Appendix A: Parameter Numbers and Locations

ID	Parameter Name	Holding Register Number	Holding Register Address	Default Units
1	Temperature	5451	5450	1 = °C
2	Pressure	5458	5457	17 = PSI
3	Depth	5465	5464	38 = feet
4	Level, Depth to Water	5472	5471	38 = feet
5	Level, Surface Elevation	5479	5478	38 = feet
9	Actual Conductivity	5507	5506	65 = $\mu\text{S}/\text{cm}$
10	Specific Conductivity	5514	5513	65 = $\mu\text{S}/\text{cm}$
11	Resistivity	5521	5520	81 = ohm-cm
12	Salinity	5528	5527	97 = PSU
13	Total Dissolved Solids	5535	5534	114 = ppt
14	Density of Water	5542	5541	129 = g/cm^3
16	Barometric Pressure	5556	5555	22 = mmHg
17	pH	5563	5562	145 = pH
18	pH mV	5570	5569	162 = mV
19	ORP	5577	5576	162 = mV
20	Dissolved Oxygen Concentration	5584	5583	117 = mg/L
21	Dissolved Oxygen % Saturation	5591	5590	177 = % Saturation
24	Chloride (Cl)	5612	5611	117 = mg/L
25	Turbidity	5619	5618	194 = NTU
30	Oxygen Partial Pressure	5654	5653	26 = torr

ID	Parameter Name	Holding Register Number	Holding Register Address	Default Units
31	Total Suspended Solids	5661	5660	117 = mg/L
32	External Voltage	5668	5667	163 = Volts
33	Battery Capacity (remaining)	5675	5674	241 = %
34	Rhodamine WT Concentration	5682	5681	118 = µg/L
35	Rhodamine WT Fluorescence Intensity	5689	5688	257 = RFU
36	Chloride (Cl) mV	5696	5695	162 = mV
37	Nitrate as Nitrogen (NO ₃ ⁻ -N) concentration	5703	5702	117 = mg/L
38	Nitrate (NO ₃ ⁻) mV	5710	5709	162 = mV
39	Ammonium as Nitrogen (NH ₄ ⁺ -N) concentration	5717	5716	117 = mg/L
40	Ammonium (NH ₄) mV	5724	5723	162 = mV
41	Ammonia as Nitrogen (NH ₃ -N) concentration	5731	5730	117 = mg/L
42	Total Ammonia as Nitrogen (NH ₃ -N) concentration	5738	5737	117 = mg/L
50	Chlorophyll-a Concentration	5794	5793	118 = µg/L
51	Chlorophyll-a Fluorescence Intensity	5801	5800	257 = RFU
54	Blue Green Algae-Phycocyanin Concentration	5822	5821	118 = µg/L
55	Blue Green Algae-Phycocyanin Fluorescence Intensity	5829	5828	257 = RFU
58	Blue Green Algae-Phycoerythrin Concentration	5850	5849	118 = µg/L

ID	Parameter Name	Holding Register Number	Holding Register Address	Default Units
59	Blue Green Algae-Phycoerythrin Fluorescence Intensity	5857	5856	257 = RFU
67	Fluorescein WT Concentration	5913	5912	118 = µg/L
68	Fluorescein WT Fluorescence Intensity	5920	5919	257 = RFU
69	Fluorescent Dissolved Organic Matter Concentration	5927	5926	118 = µg/L
70	Fluorescent Dissolved Organic Matter Fluorescence Intensity	5934	5933	257 = RFU
80	Crude Oil Concentration	6004	6003	118 = µg/L
81	Crude Oil Fluorescence Intensity	6011	6010	257 = RFU
87	Colored Dissolved Organic Matter Concentration	6053	6052	118 = µg/L

Appendix B: Unit IDs

ID	Abbreviation	Units
1	C	Celsius
2	F	Fahrenheit
3	K	Kelvin
Pressure, Barometric Pressure (17-32)		
17	PSI	Pounds per square inch
18	Pa	Pascals
19	kPa	Kilopascals
20	Bar	Bars
21	mBar	Millibars
22	mmHg	Millimeters of Mercury (0 to C)
23	inHg	Inches of Mercury (4 to C)
24	cmH ₂ O	Centimeters of water (4 to C)
25	inH ₂ O	Inches of water (4 to C)
26	Torr	Torr
27	atm	Standard atmosphere
Distance/Length (33-48)		
33	mm	Millimeters
34	cm	Centimeters
35	m	Meters
36	km	Kilometer
37	in	Inches
38	ft	Feet
Coordinates (49-64)		
49	deg	Degrees
50	min	Minutes
51	sec	Seconds

Conductivity (65-80)		
65	μS/cm	Microsiemens per centimeter
66	mS/cm	Millisiemens per centimeter
Resistivity (81-96)		
81	ohm-cm	Ohm-centimeters
Salinity (97-112)		
97	PSU	Practical Salinity Units
98	ppt	Parts per thousand salinity
Concentration		
113	ppm	Parts per million
114	ppt	Parts per thousand
115		(Available)
116		(Available)
117	mg/L	Milligrams per liter
118	μg/L	Micrograms per liter
119	---	(Deprecated)
120	g/L	Grams per liter
121	ppb	Parts per billion
Density (129-144)		
129	g/cm ³	Grams per cubic centimeter
pH (145-160)		
145	pH	pH
Voltage (161-176)		
161	μV	Microvolts
162	mV	Millivolts
163	V	Volts
Dissolved Oxygen (DO) % Saturation (177-192)		
177	% sat	Percent saturation
Turbidity (193-208)		
193	FNU	Formazin nephelometric units
194	NTU	Nephelometric turbidity units
195	FTU	Formazin turbidity units

Flow (209-224)

209	ft ³ /s	Cubic feet per second
210		(Available - was Cubic feet per minute)
211		(Available - was Cubic feet per hour)
212	ft ³ /day	Cubic feet per day
213	gal/s	Gallons per second
214	gal/min	Gallons per minute
215	gal/hr	Gallons per hour
216	MGD	Millions of gallons per day
217	m ³ /sec	Cubic meters per second
218		(Available - was Cubic meters per minute)
219	m ³ /hr	Cubic meters per hour
220		(Available - was Cubic meters per day)
221	L/s	Liters per second
222	ML/day	Millions of liters per day
223	mL/min	Milliliters per minute
224	kL/day	Thousands of liters per day

Volume (225-240)

225	ft ³	Cubic feet
226	gal	Gallons
227	Mgal	Millions of gallons
228	m ³	Cubic meters
229	L	Liters
230	acre-ft	Acre feet
231	mL	Milliliters
232	ML	Millions of liters
233	kL	Thousands of liters
234	Acre-in	Acre inches

% (241-256)

241	%	Percent
-----	---	---------

Fluorescence (257-2720)

257	RFU	Relative Fluorescence Units
-----	-----	-----------------------------

Low-Flow (273-288)

273	mL/sec	Milliliters per second
274	mL/hr	Milliliters per hour
275	L/min	Liters per minute
276	L/hr	Liters per hour

Current (289-304)

289	μ A	Microamps
290	mA	Milliamps
291	A	Amps

Velocity (305-320)

305	ft/s	Feet per second
306	m/s	Meters per second
