



PhoCheck TIGER

Instrument User Manual V1.3



Part Number: 861265

Advanced Gas Sensing Technologies

Ion Science Ltd, The Way, Fowlmere, Cambs., SG8 7UJ, U.K.
Tel: +44 (0) 1763 208 503 Fax: +44 (0) 1763 208 814
Email: info@ionscience.com Web: www.ionscience.com



blank page



WARNINGS

User Manual:	Read and understand this user manual completely before operating the PhoCheck TIGER instrument.
Static Hazards:	Do not use abrasive or chemical detergents to clean the PhoCheck TIGER instrument as this may reduce the antistatic properties of the materials used. Clean it using a damp cloth only.
Servicing:	The PhoCheck Tiger should be serviced by Ion Science Ltd authorised service centres only. The PhoCheck TIGER must never be serviced in a potentially explosive environment.
Spares & Accessories:	Only use genuine Ion Science replacement parts. Failure to do so may invalidate the PhoCheck Tiger instruments certification.
Battery Charging:	Never charge PhoCheck Tiger Instruments or their batteries in potentially explosive or hazardous locations.
Battery Replacement:	Never replace Alkaline battery cells into the Alkaline battery pack housing while in a potentially explosive or hazardous location. Only fit Duracell MN1500 Alkaline batteries within the Alkaline battery pack. Never recharge Alkaline batteries.



Declaration of conformity

Manufacturer: Ion Science Ltd, The Way, Fowlmere, Cambridge, England. SG8 7UJ

Product: PhoCheck TIGER

Product description: Intrinsically safe photo-ionisation gas detector for detecting volatile organic compounds

Directive 94/9/EC **ATEX**

Identification ATEX: Ga Ex ia IIC T4 ($T_{amb} = -15c$ to $+60c$). ETL and cETL pending

Notified body Standards Intertek,

EN61326-1:2006 Electrical equipment for measurement, control and laboratory use - EMC requirements. Group 1, Class B equipment - (emissions section only)

EN61326-1:2006 Electrical equipment for measurement, control and laboratory use - EMC requirements. Industrial location immunity - (immunity section only)

EN50270:2006 Electromagnetic compatibility - Electrical apparatus for the detection and measurement of combustible gases, toxic gases or oxygen. Immunity Type 2 - industrial environments.

CFR 47:2008 Class A
Code of Federal Regulations: 15 Subpart B- Radio Frequency Devices - Unintentional Radiators.

Other Standards

EN ISO 9001: 2008 Quality Management System - Requirements

EN 13980: 2002 Potentially Explosive Atmospheres - Application of Quality Systems

On behalf of Ion Science Ltd, I declare that, on the date this product accompanied by this declaration is placed on the market, the product conforms to all technical and regulatory requirements of the above listed directives.

Name: Mark Stockdale

Position: Technical Director

Signature:

Date: 20th January 2010

* Based on ambient temperature of 20°C



Contents	Page
Warnings	3
Declaration of Conformity	4
Contents	5-6
Statements	7
Responsibility for use	7
Caution	7
Quality Assurance	7
Disposal	7
Calibration Facility	7
Ion Science Contact Details	7
Introduction to PhoCheck TIGER	8
Getting Started	9
Understanding the Keypad	10
Understanding the Display Screen	11-13
Status Icons	11-12
Main Screen area	12
Soft Key areas	13
Using your TIGER	14-16
On	14
Off	14
Sleep	14
Zeroing	14
Zones	14
Data-logging	14
Multiple data-logging	14
Health and Safety readings	15
Gas selection	15
Peak hold	15
Average	15
Options	15
Backlight	15
Sound	15
Calibration	15
Alarms	16
Information	16



Contents (continued)	Page
TIGER PC Software	17-28
PC Requirements	17
Installation of TIGER PC Software	19
Connecting TIGER to a PC	20
The Features Screen	20
The Configuration Screen	21-23
The Gas Table Screen	24
The Firmware Screen	25
Downloading data-logged readings	26
Health and Safety screen	27
Snapshots	27
Software disclaimers	28
Batteries	29-31
Replacement of rechargeable battery pack	30
Replacement of non-rechargeable batteries	31
Diagnostics	32
Maintenance	33-36
Calibration	33-34
Probes	34
Filter	34
PID Sensor/Lamp replacement & cleaning	35-36
TIGER Parts	37
Accessories	38
Service Options	39
Technical Specification	40
Manual History	41



Statements

Responsibility for Use

PhoCheck Tiger instruments detect a large range of gases which are potentially dangerous from both a poisoning and/or an explosive perspective. PhoCheck Tiger instruments have many adjustable and selectable features allowing the detector to be used in a variety of ways. Ion Science Ltd can accept no responsibility for the incorrect adjustment of features that cause harm or damage to persons or property. PhoCheck Tiger can be used as a personal safety device. It is the user's responsibility to respond appropriately to an alarm situation.

!CAUTION!

It is essential that the PhoCheck TIGER is always used with a supplied PTFE 0.5 micron filter fitted to the front of the instrument. Without a filter, particles of debris and dust can be drawn into the detector inhibiting the function of the instrument. These filters are consumable and should be changed after every 100 hours of use. The frequency of replacement should be increased for dusty or moisture laden environments. Filters are available from your distributor or at www.ionscience.com.

Quality Assurance

PhoCheck TIGER has been manufactured in compliance with ISO9001:2000, which ensures that the equipment supplied to our customers has been designed and assembled reproducibly, from traceable components, and leaves Ion Science calibrated to stated standards.

Disposal

Dispose of PhoCheck TIGER, its components and any used batteries in accordance with all local and national safety and environmental requirements. This includes the European WEEE (Waste Electrical and Electronic Equipment) directive. Ion Science Ltd offers a take back service. Please contact us for more information. The PhoCheck TIGER field case material is recyclable polypropylene.

Calibration Facility

Ion Science Ltd offers a calibration service including the issue of certification confirming calibration with equipment traceable to national standards. A PhoCheck TIGER calibration kit is available from your distributor or service centre or at www.ionscience.com. Ion Science recommends annual return of all instruments for yearly service and calibration.

Ion Science Contact Details

UK Head Office

Ion Science Ltd
The Way,
Fowlmere
Cambridge
SG8 7UJ
UK

Tel: +44 (0)1763 207206

Fax: +44 (0) 1763 208814

Email: info@ionscience.com

Web: www.ionscience.com

USA Office

Ion Science Americas LLC
35 Crossroad
Waterbury
VT 05676
USA

Tel: +1 802 244 5153

Fax: +1 802 244 8942

Email: [info@ionscience-
americas.com](mailto:info@ionscience-americas.com)

Web: www.ionscience.com

German Office

Ion Science Messtechnik
GMBH
Laubach 30
Metmann-Neandertal
40822
GERMANY

Tel: +49 2104 14480

Fax: +49 2104 144825

Email: info@ism-d.de

Web: www.ism-d.de



Introduction to PhoCheck TIGER

PhoCheck TIGER is a portable gas detector that uses Photo-ionization technology to detect a large range of Volatile Organic Compounds (VOC's) which can be dangerous from both a poisoning and explosive perspective.

The TIGER uses a Photo-Ionization Detector (PID) to measure gas concentrations. The patented fence electrode technology minimises the effects of moisture and contamination, avoiding the need for compensation.

Survey is the default mode of operation. This mode is often used in applications such as Head Space Sampling and Leak Detection where several areas (or Zones) are to be monitored and readings data logged. All sensor readings are real time measurements and alarm levels are set manually.

Health & Safety mode is used to check for conformity of short-term exposure levels (STEL) or time-weighted averages (TWA) that are specific for particular hazardous environments (for example EH40 in the UK and OSHA in the USA). In this mode of operation STEL's and TWA's are continually calculated and compared to levels set in the instrument's gas table.

The TIGER can be upgraded from the users own desk top. Additional features can be added without the need to return the instrument to a service centre.

Like it's predecessor (the PhoCheck +), the TIGER also has an intuitive graphical interface allowing easy access to instrument settings. Two soft keys can be configured to suit the users application, so many functions can be selected without entering the main menu structure. This improves efficiency of use, particularly with repeatable tasks.

TIGER PC (the TIGER's PC Software) maintains the intuitive look and feel by adopting the same graphical symbols. TIGER PC also helps manage logged data files and multiple instrument settings in a clear and concise way.

The TIGER uses a Lithium-ion battery that not only boasts an impressive running time and short charge time, but also allows battery packs to be replaced in potentially hazardous environments. Field replaceable alkaline battery packs are also available for when power to charge is unavailable.

The TIGER has true USB capability so the instrument can be connected directly to a PC via a standard USB cable. It also offers fast data download.

A loud audio output, vibration and bright LED's indicate alarm conditions. Orange and Red LED's indicate High and Low conditions respectively. This colour scheme is used within TIGER PC to offer clear indication of alarm levels within logged data.



Getting started

Thank you for choosing TIGER from Ion Science Limited. We hope that your TIGER will give you many years of active and trouble-free service.

The Manual

Ion Science Ltd recommend that you familiarise yourself with this manual before using your TIGER. Pages 7 & 8 contain important information, which should be read before you turn your TIGER on for the first time.

Probes

Ensure that the probe supplied is fitted to your TIGER. Details on how to fit and change probes is detailed in the Maintenance section on page 33. If the supplied probe is unsuitable for your application, details of alternative probes can be found on page 34.

Turn On.

Press the ON/OFF / ENTER key once to turn TIGER on.



Turn Off

Press and hold the ON/OFF / ENTER key for three seconds to turn TIGER off. (NOTE If the TIGER fails to shut down, press the ESCAPE key once or twice to return to the main screen, then press and hold the ON/OFF / ENTER key again.)



Batteries

Check that your TIGER has sufficient charge for use. The battery icon (see Understanding the display screen, page 11) should show at least two full segments.

Rechargeable Batteries

TIGER instruments leave the factory with the rechargeable battery fully charged. However prolonged periods of storage may result in the battery pack discharging. We recommend charging the instrument for seven hours before use. See the battery section of this manual, page 29.

Alkaline Batteries

An alkaline battery pack is also supplied with the PhoCheck TIGER. For more information please see the battery section of this manual, page 29.

Select the gas

TIGER instruments leave Ion Science pre-set for gas type TVOC (total volatile organic compounds). Instruments are factory calibrated against isobutylene and all response factors are equivalent to this. By changing the gas from the internal gas table all readings will be given using that gas's response factor.

- Turn the TIGER on by pressing the On/Off / Enter key once.
- Press the information icon  (see page 16) and check the correct gas, alarm levels and flow rate are selected.
- Change the gas (if necessary) as instructed under Gas Selection on page 15.

Set alarm levels

We recommend that alarm levels are set to user specifications as soon as possible before the TIGER is used for the first time. Please see page 16 for details of how to set alarm levels.

TIGER PC

The full functionality of your TIGER can only be realised through the TIGER PC software. Ion Science Ltd recommend that you load the software supplied with your instrument and set up your TIGER according to the instructions on page 17 of this manual.



Understanding the Keypad

General description

The keypad comprises two soft keys: A and B, up and down arrow keys, an escape key, and an enter/off button, which also serves also as an enter key. In general, setup and application settings are selected and adjusted via the soft keys, options are selected by the arrow keys and confirmed by the enter key. A single press is used as a switching operation. A continuous press is used to adjust numbers or change gas selections by automatically rolling.

Keypad function descriptions



Soft keys A & B rely on graphical prompts on the display to indicate their functionality.

NOTE: Pressing both soft keys together switches the torch on and off.



Up & Down keys are used to adjust settings and navigate through the menu structure.



Enter / On/Off key is used to accept adjustments and select functions; also to turn the TIGER on and off.



Escape (Esc) key is used to abort an adjustment or exit from a menu.

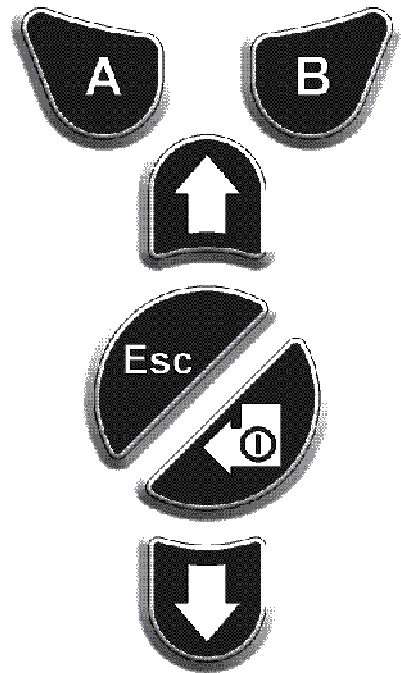



Understanding the display screen

Screen display

The display is divided into four sections.

Fixed LCD Status icons fill the top of the screen offering instrument status at a glance. The icons display only when a function is selected. The main central viewing screen will display readings in large numbers only, 4 digits and decimal place will display 0.001 ppm to 9,999 ppm. Two soft key areas have been set aside as soft key indicators. The area between the soft key indicators displays the measurement units.



Left is the default display with no functions active.



Right is the display with all functions active.

Status icons



Health & Safety: The icon consists of a single part and will flash in an alarm condition and when health and safety readings are being collected.



Peak Hold: When peak hold is switched on, the icon appears.

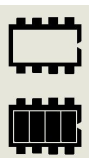

Memory status: This icon only appears if the instrument has the data logging functionality. Four sections within the border fill as the data log memory is filled. Empty border = 100% memory available through to full, where all segments are present.



USB: The icon will appear when connected to a host device.



Battery status: This icon consists of a border and four segments. The segments fill or empty to indicate 0-25, 26-50, 51-75 & 76-100% full. When discharging, the border will flash for 1 minute before the instrument shuts down. When charging, the segments will successively fill until 100% charge is reached.



Understanding the display screen (continued)



Back light: Light beam lines appear when the backlight is on.



Sound: The main body of the icon is present at all times. The disable lines appear if all 3 alarm sounders are disabled and the volume is at 0%. Three sound projection lines indicate the volume level. However there are four sound levels and the quietest level has no line.



Alarm bell: The icon consists of 2 parts, the Bell and the sound bars. When the instrument reaches a 'Low alarm' the Bell and one sound bar will flash; when a 'High alarm' is reached the Bell and both sound bars flash.



Flash light / Torch: When the flashlight is illuminated the light beams appear.



Lock: The Lock icon will appear when the configuration of the TIGER has been locked in Tiger PC.

Main Screen Area

During normal operation this area displays the readings in four large numbers, with the units of measurement below.

During setup and adjustment, a function bar overlays the main screen.



Understanding the display screen (continued)

Soft key areas





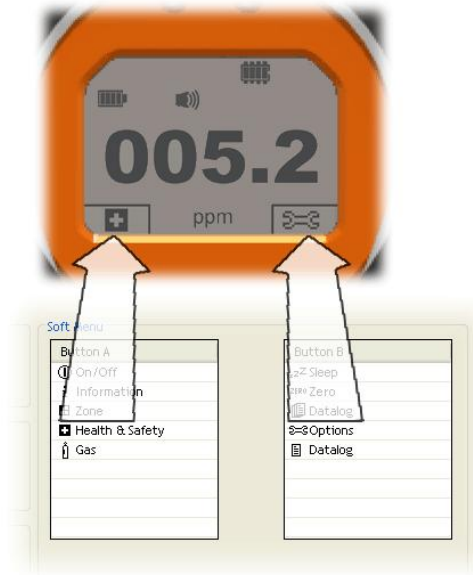

The following icons will appear in the soft key areas as soft key options. They are selected using the UP and DOWN keys. Those labelled optional will only appear if your TIGER has that functionality.

These icons can be reorganised using the TIGER PC software.







Button A



-  Information
-  Zone(s)
-  Gas selection
-  Options
-  Health & safety (optional)
-  Multiple data logging (optional)

Button B



-  Sleep
-  Zeroing
-  Peak hold
-  Average
-  Data log (optional)





Using your TIGER

Instrument functionality is broken into two parts; Application and Setup. Application settings are initially selected via the soft keys. Setup functions like backlight, sound, calibration and alarm setting are adjusted within the Adjust soft key setting. Many of the screens have a 2 second time out which returns to the main screen if no other keys are pressed.



ON To switch the TIGER on press the On/Off / Enter key once. Start up screen 1 appears showing the TIGER logo. Start up screen 2 contains variable text sent from the TIGER PC configuration screen. The lower half of the screen contains the instrument serial number and firmware version. The third screen shows TIGER checking that the lamp has struck. When  appears, the working screen will follow. If the lamp fails to strike, turn TIGER off, wait for 30 seconds and try again. If the problem persists, change the lamp or contact Ion Science Ltd or your distributor.

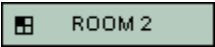

OFF To switch the TIGER off press and hold the On/Off / Enter key. A three-second count down takes place before the instrument shuts down. During this count down the instrument activates the upper alarm. viz. RED LED's flash and audible alarm sounds. This is done to alert the user to avoid accidental switch off.

 **SLEEP** Press and hold the Zzz soft key to send the TIGER to sleep. A three-second count down takes place before entering sleep mode. This function is not available when the instrument is locked. All peripherals switch off. Only 'Zzz' remains on screen. Press ESC key to awaken the instrument. (The instrument can also enter 'Sleep mode' during data logging when the duration between logs exceeds 2 minutes. This is a power saving function which only occurs when a tick box is set in TIGER PC.)

 **ZEROING** Pressing the Zero soft key presents two zero options  selected with the UP or DOWN keys. The upper symbol represents an absolute zero. The lower symbol represents a relative zero which follows the drift of the PID detector. Having made your selection, press Esc. If the relative zero has been selected TIGER will zero itself before returning to the main screen.

 **ZONES** Press the Zone soft key to display the currently selected Zone.  The TIGER's default is 'Zone 1' Zones are set up in TIGER PC only and the name given to the zone(s) will appear on the screen.. Use Up and Down keys to select alternative zones.

 **DATA-LOGGING** Press the Single Data log soft key to take a single data log reading. The single data log symbol appears with a tick.  Press Esc to return to the main screen. Press the Single Data log soft key again to take another reading.. The fixed LCD memory icon flashes off when a single log is taken.



 **MULTIPLE DATA-LOGGING** Pressing the Multiple Data log soft key results in the multiple log symbol appearing with a question mark.  Press the ENTER key to start the data logging process based on TIGER PC set-up. A tick appears beside the question mark, confirming that data logging has started. The fixed LCD memory icon flashes at 1 Hz while continuous data logging is in progress. Press Esc to return to the main screen. To stop data logging, press the soft key again. A crossed out data log symbol is presented with a question mark. Press the ENTER key to confirm the action. A tick appears beside the question mark, confirming that data logging has stopped and the LCD memory icon ceases to flash. Press Esc to return to the main screen.



Using your TIGER (continued)

HEALTH & SAFETY readings Press the Health & Safety (H&S) soft key to display the H&S symbol with a question mark to ask if the user wishes to proceed.

 Press ENTER to start the calculation. The STEL (Short Term Exposure Level) and TWA (Time Weighted Average) values are shown. The fixed LCD H&S icon will continually flash while calculating. Pressing the ENTER key while the values are displayed presents the user with a screen asking if the calculation should stop. Press ENTER again to stop the calculation. Press Esc to return to the main screen.

GAS SELECTION Press the Gas soft key to display an alphabetical letter which can be changed using the Up and Down keys.  Press the ENTER key to present the gases beginning with that letter. Using the Up and Down keys scroll through the gases starting with that letter to find the subject gas. Press enter to select the chosen gas. If a tick appears, press Enter again and TIGER will use the relevant data for the chosen gas from the gas table for alarms and response factor etc. Should the selected gas have no numeric response factor then a warning screen  will appear. The message can be cleared by pressing the ENTER key and the gas will still be selected. An alternative lamp type may then be selected to match the chosen gas. Should an incompatible gas/lamp combination be selected the instrument will show the warning screen again.

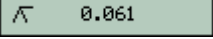
PEAK HOLD Press the Peak Hold soft key to present the screen  When 'Peak hold' is selected the sub display will appear and this will continue to display the peak reading until peak hold is no longer required. To deselect the peak hold function press Esc.

AVERAGE Press the Average soft key to display a rolling average over 10 seconds. A tick appears when time is up. Pressing the 'Average soft key' again resets the calculation even if there is an average already running. Press ESCAPE to return to the main screen.

OPTIONS Press the Options soft key to give access to various adjustable features, selected with the UP and DOWN keys. Press ENTER to confirm selection.



BACKLIGHT Four options are presented: ~~P~~ermanently Off, ~~P~~ermanently On, ~~O~~n in low ambient light, and ~~T~~imed (Set the time in TIGER PC - see page 21). Select the preferred option with the UP and DOWN keys and confirm with ENTER.

SOUND The sound options are presented as set up in Tiger PC. Use the DOWN arrow to select either keypad beep, alarm sound, crescendo or percentage volume. Press ENTER to turn selection on or off. For percentage volume, press ENTER again to confirm selection. The frame will flash. Use UP and DOWN arrows to change the percentage volume and press ENTER to confirm the chosen value. Press Esc twice to return to the main screen.

CALIBRATION Only two options are presented: Factory calibration and Custom calibration. Select the preferred option with the UP and DOWN keys and confirm with ENTER. Whichever calibration standard is selected, the TIGER will operate against that calibration. Readings taken against unsatisfactory calibrations may be unreliable.



Using your TIGER (continued)



Factory Calibration Not for operator use.



Return to Ion Science Ltd or your distributor for calibration. (see also page 33)



Custom Calibration see under Maintenance on page 33.



ALARMS

Upper  and Lower  alarm settings are displayed. Select the subject alarm using the UP and DOWN keys and press ENTER. The arrow(s) on the chosen alarm will flash. Adjust the level using the UP and DOWN keys and press ENTER. Repeat, if necessary for the other alarm. Press Esc twice to return to the main screen.

NOTE: The Lower alarm setting must never be greater than the Higher alarm.



INFORMATION

Pressing the Information soft key allows access to a number of other information screens. Use the DOWN key to scroll through the screens. Press ESCAPE to return to the main screen:

First Screen

Gas selected



Upper alarm



Lower alarm



Pump flow



Second screen

Lamp selected



Date of Factory calibration



Date of Custom calibration



Date and time



Third Screen

SPAN 1

 (gas concentration set in TIGER PC)

SPAN 2

 (gas concentration set in TIGER PC)

PID detector

A/D reading



Fourth Screen

Temperature



(optional upgrade module)

Barometric pressure



(optional upgrade module)

Relative humidity



(optional upgrade module)

Battery type and status



Fifth Screen

STEL

TWA

Serial number of instrument

Firmware version

Bootloader version



TIGER PC Software

PC Requirements

TIGER PC Software must be used in conjunction with a PC or laptop using Windows XP, Windows Vista or Windows 7. The software is supplied on a USB memory stick.

Installation of TIGER PC Software

Plug the memory stick into a USB socket on your computer.

On the TigerPC screen (below), select **Install TigerPC** and click OK.

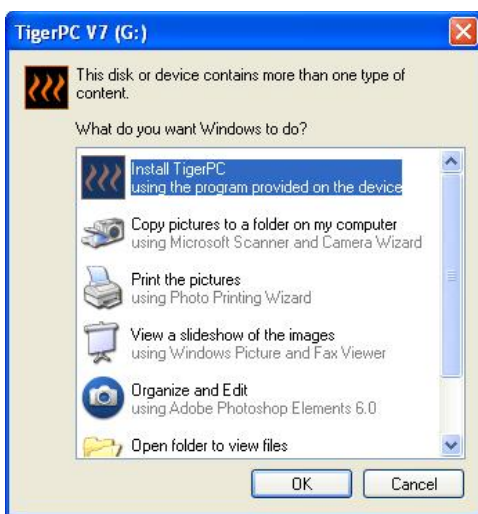

On the Ion Science screen (below), select **Install Tiger Software**

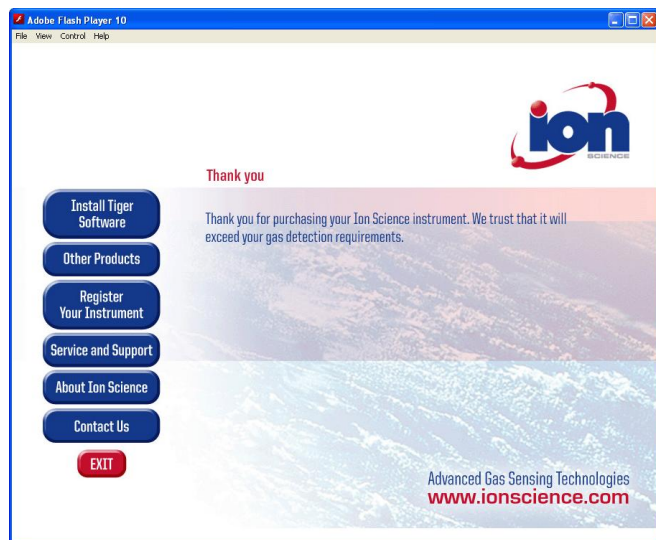

On the Welcome screen (below), click **Next** to proceed.



On the select destination location screen (below), click **Next** to create an **Ion Science** folder on your C drive.

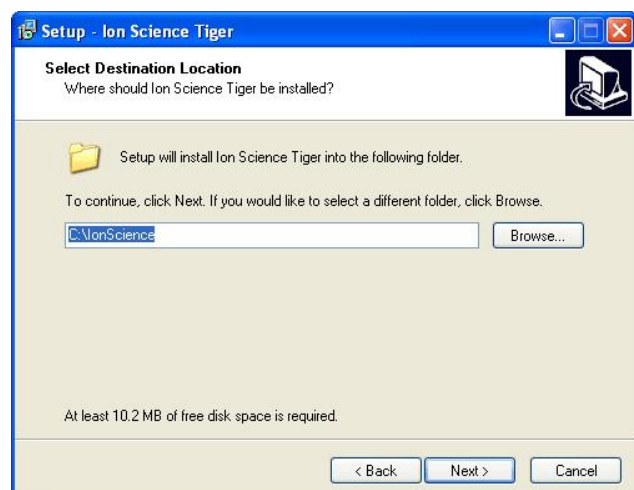



TIGER PC Software (continued)

On the set up screen (below) click **Next** to create an Ion Science start up folder.

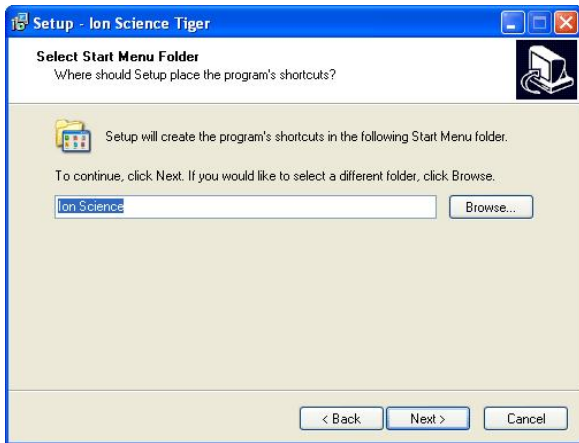

On the additional tasks screen (below) tick the box and click **Next** to create a desktop icon.

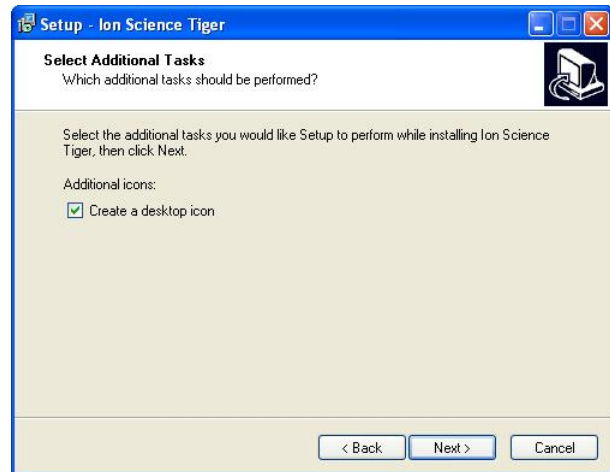

On the ready to install screen (below), click **Install**

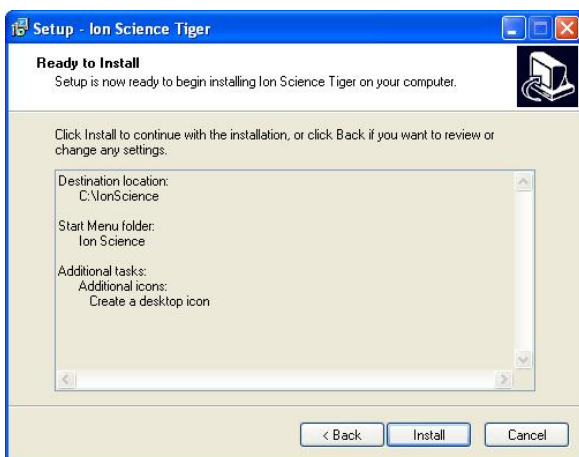

On the install screen (below) Click **OK**

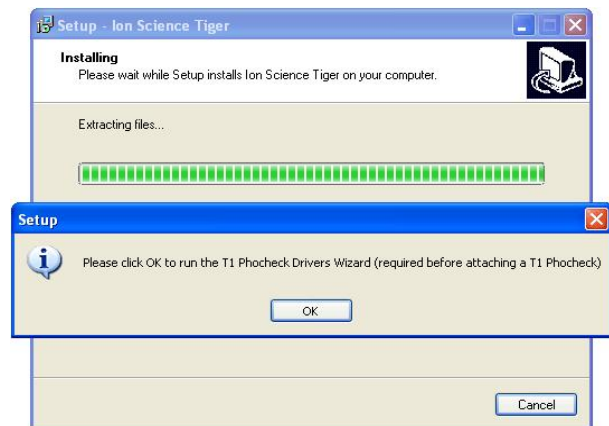

Click **Next** on the Device Driver screen,



Finish on the installation wizard



and **Finish** on the Setup wizard.



Finally Exit the Ion Science screen.

The Tiger icon should appear on your desktop.



TIGER PC Software (continued)

Connecting TIGER to a PC

1. Double click the TIGER icon on your desktop and open TIGER PC. The Home page should appear.

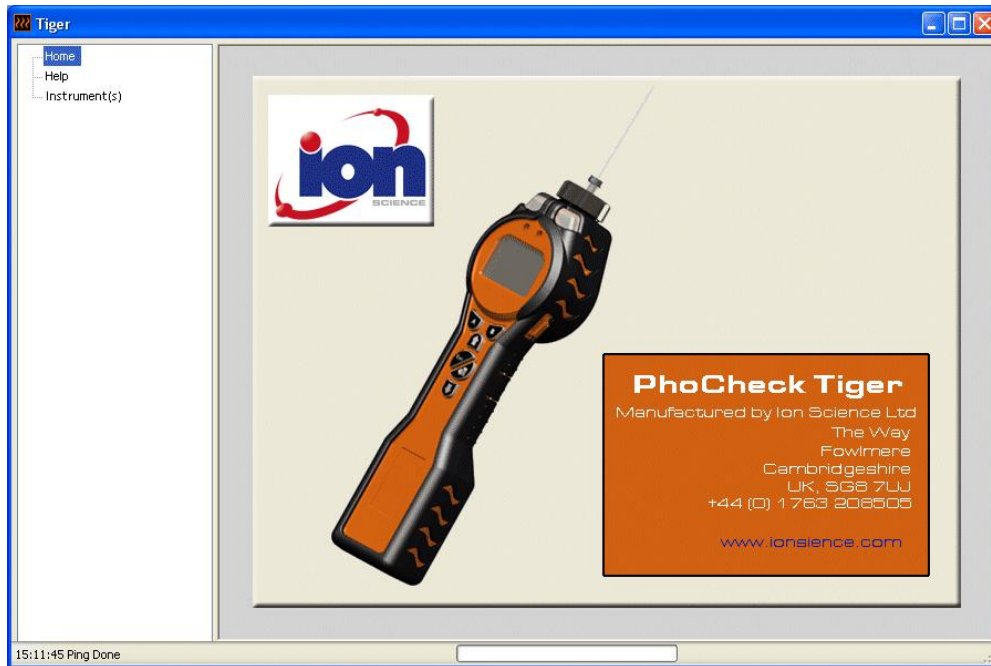

2. Click on **Instrument(s)**. If your TIGER has previously been connected to your PC your instrument number will appear.
Note: If, while using this software your TIGER should inadvertently be turned off or disconnected from your computer, click on 'Instrument(s) again and proceed as below.

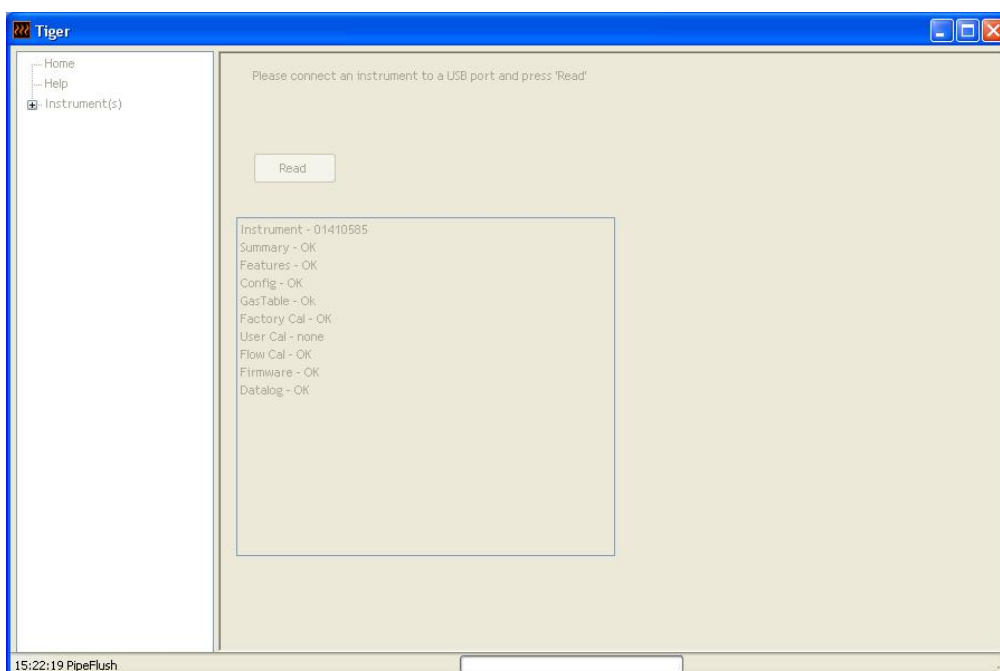



TIGER PC Software (continued)

- Switch TIGER on and when fully booted up connect to a USB socket on your PC using the USB cable supplied. If the Found New Hardware screen appears, follow the prompts to install your instrument on your PC.
- Click on Read Your instrument number will appear under instrument(s) (if it was not there already) and the Instrument Summary page will appear. This page gives the current status of your TIGER. If the snapshot screen appears click Yes You can delete the snapshot later if you wish. (see page 27).

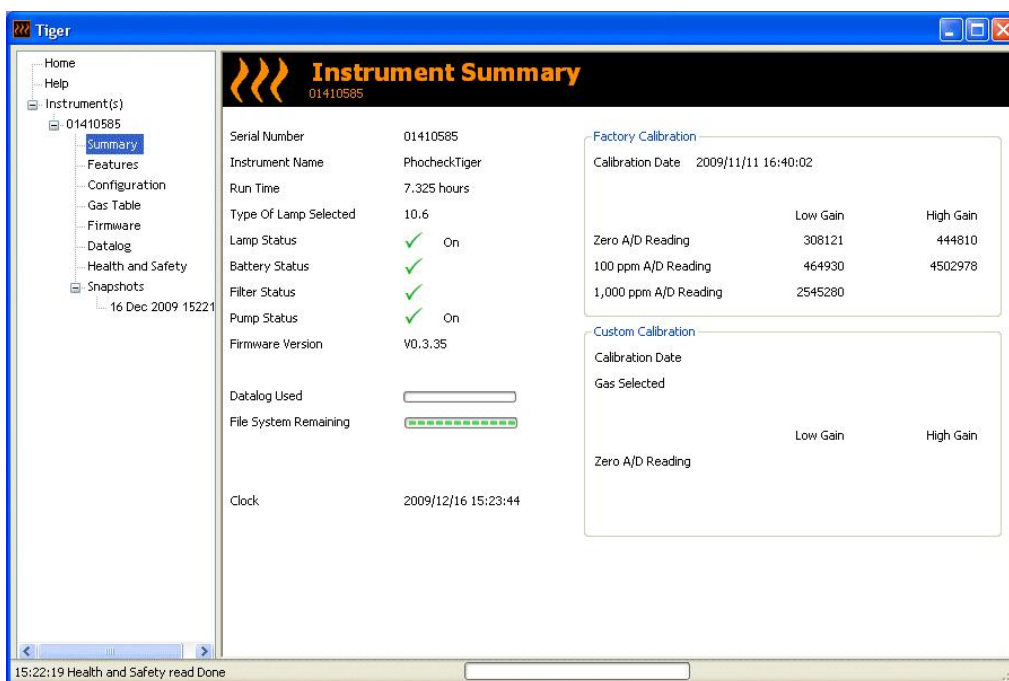

The Features Screen

The Features screen indicates which of the available updates has been added to your TIGER.

Should you wish to purchase additional features, contact Ion Science Ltd or your Distributor.

Some updates may be available on the website www.ionscience.com.

Once the transaction is complete and confirmed, click on Update to add the relevant features to your TIGER.

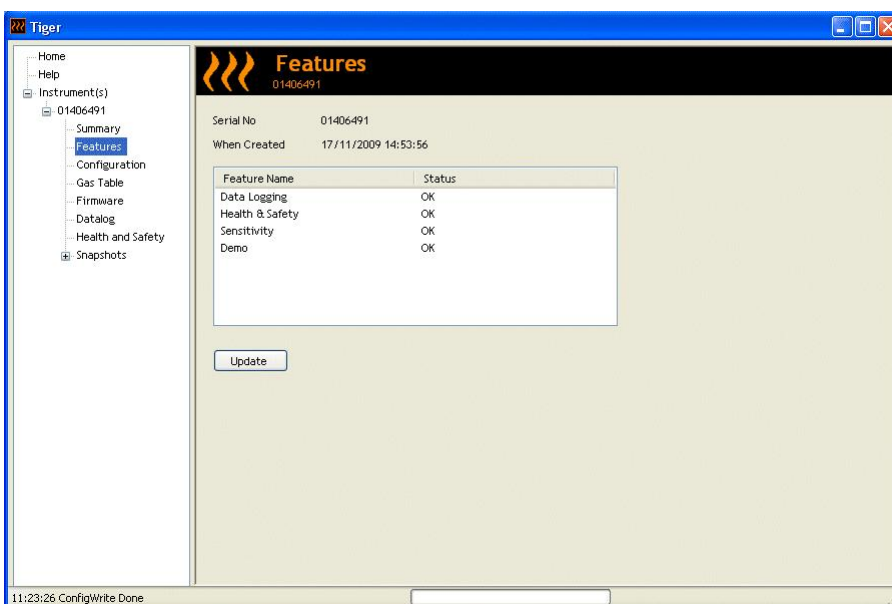



TIGER PC Software (continued)

The Configuration Screen

Use this screen to configure your TIGER.

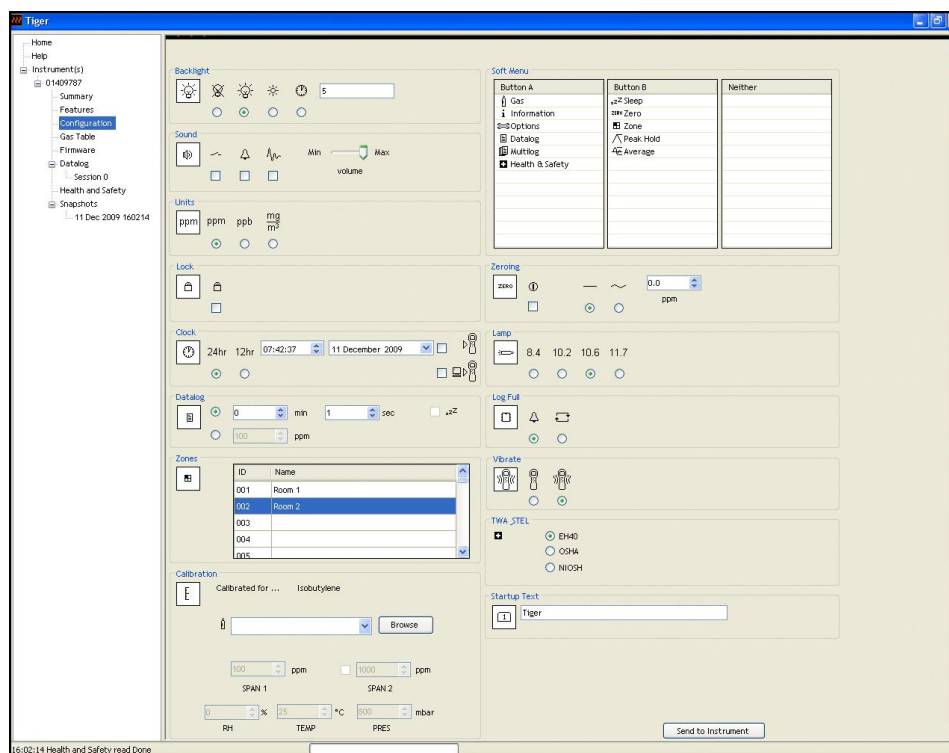

Backlight

Choose from Permanently Off, Permanently On, On in low ambient Light, or On For Limited Time. The Backlight Timeout can be set from 1 to 99 seconds.

Sound

The three icons represent: key press; alarm; and crescendo. Crescendo increases the sound as the upper alarm is approached. Sound on each of these may be enabled or disabled by ticking or un-ticking the box. Sound volume is adjusted with the slider.

Units

The units of measurement may be chosen as parts per million (ppm), parts per billion (ppb) or milligrammes per cubic metre (mg/m^3).

Soft Menu

The various functions may be allocated to the soft buttons in any order of preference by dragging and dropping the icons.



TIGER PC Software (continued)

Lock

The TIGER may be locked in any configuration to avoid unauthorised changes by the operator. A tick in the box locks the instrument.

Zeroing

This function allows either an assumed constant zero or for the zero to be tracked compensating for the shift in the zero of the PID lamp during operation. The function may be enabled or disabled by ticking or un-ticking the box. Constant or tracked zero is selected by use of the radio buttons associated with the icons.

Clock

Select 24 or 12 hour format using the radio buttons. Set the time and date and tick the box on the right to set the time on your TIGER. Alternatively, tick the lower box to synchronise your TIGER with the time on your computer.

Lamp

Enables the selection of different lamp types you may have purchased to use with your instrument. Ensure that the lamp selected is the same as that fitted in your TIGER. If not, select the correct lamp from the options provided.

Datalog

Use this area to set the interval between readings. The minimum time permitted is one second. If you wish your TIGER to switch to sleep mode during data-logging, tick or un-tick the sleep box to enable or disable the function. The sleep mode will only operate for datalog intervals of 2 minutes or greater.

Log full

If you select the bell symbol your TIGER will alarm when the memory log is full. Alternatively, if you wish new data to overwrite the oldest stored data in the memory and continue to store new data during data-logging, select the recycle symbol.

Zones

Use this table to define and name up to 128 separate zones. The name field is limited to eight characters including spaces.

Vibrate

To set your TIGER to vibrate under alarm conditions select the  symbol.

TWA STEL

Select the appropriate regulatory code to which you are working.



TIGER PC Software (continued)

Calibration

Use this area to define your Custom Calibration parameters.

First connect TIGER to your PC as detailed above under [Connecting your TIGER to a PC](#)

If no gas is shown in the drop down box, browse your system to find the gas table for your instrument. Go to the location where the TIGER PC software files are saved. Follow the path:

IonScience/Tiger/software/instruments/
serial no./gastable.

Select the appropriate instrument number and open the gas table.

Select the calibration gas using the drop-down box.

TIGER PC offers a two-point calibration

(zero + span 1) or three-point (zero + span 1 + span 2) calibration. Enter the SPAN 1 concentration. For two-point calibration ensure that the box is un-ticked. For three-point calibration tick the box and enter the SPAN 2 concentration. Send this information to your TIGER. The calibration procedure is detailed under Maintenance on page 33 of this manual.

Startup Text

Enter the text you wish to appear on the start-up screen of your TIGER.

Send to Instrument

When you have configured your instrument or completed your changes, send them to your TIGER by clicking the [Send to Instrument](#) box. If the message [There was a problem sending to the instrument](#) appears, click OK and return to the Home screen. Repeat the procedure under [Connecting your TIGER to a PC](#) above. If the [Summary](#) screen for your TIGER appears, visit the configuration screen again. If not, repeat the entire procedure. If your PC still fails to read or write to your TIGER seek advice from your distributor or from Ion Science.



TIGER PC Software (continued)

The Gas Table Screen (including setting alarm levels)

Connect your TIGER to your PC as described above on page 19ff. Any fresh data-logged readings will be down loaded as the software reads your TIGER.

Select Gas Table from the menu to display the Gas Table

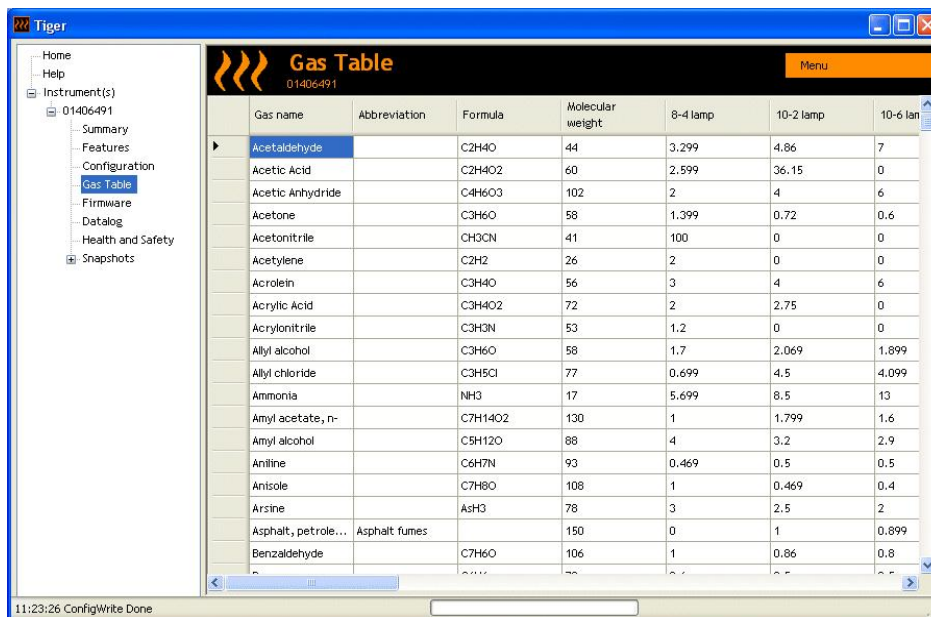

You are now able to modify this table and then download it to your instrument.

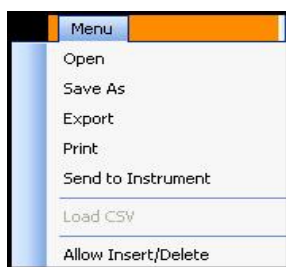

If you wish to add new gases to the table, select the **Menu** tab, and from the drop down menu select **Allow Insert/Delete**

This will add an additional line at the bottom of the Gas table which allows the user to add new gas types as below.

Xylene mixed is...		C8H10	106	0	0.43
Xylene, m-		C8H10	106	0.4	0.439
Xylene, o-		C8H10	106	0.689	0.6
Xylene, p-		C8H10	106	0.62	0.55
Xylidine, all		C8H11N	121	0	0.699
New gas	Mix				

Upper and lower alarm levels in Survey mode can be adjusted via the gas table. Type the desired alarm level in the appropriate column (either high or low alarm) against the gas you wish to change.

Always save modified gas tables under a different file name, keeping the original complete.

To send the gas table to the instrument, select **Send to Instrument** from the dropdown menu shown above.



TIGER PC Software (continued)

The Firmware Screen

This screen displays the current firmware version installed on your TIGER. It also provides a facility to download updated versions to your TIGER.

To download a firmware update, connect TIGER to your computer as detailed above on page 19ff. Ensure that your instrument is in normal Survey mode, is not in an alarm condition and that no datalogging or Health & Safety readings are being collected. Check that the battery is sufficiently charged (at least two bars). Click on **Check for Updates**

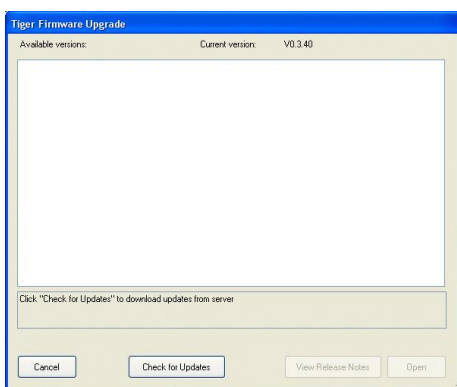
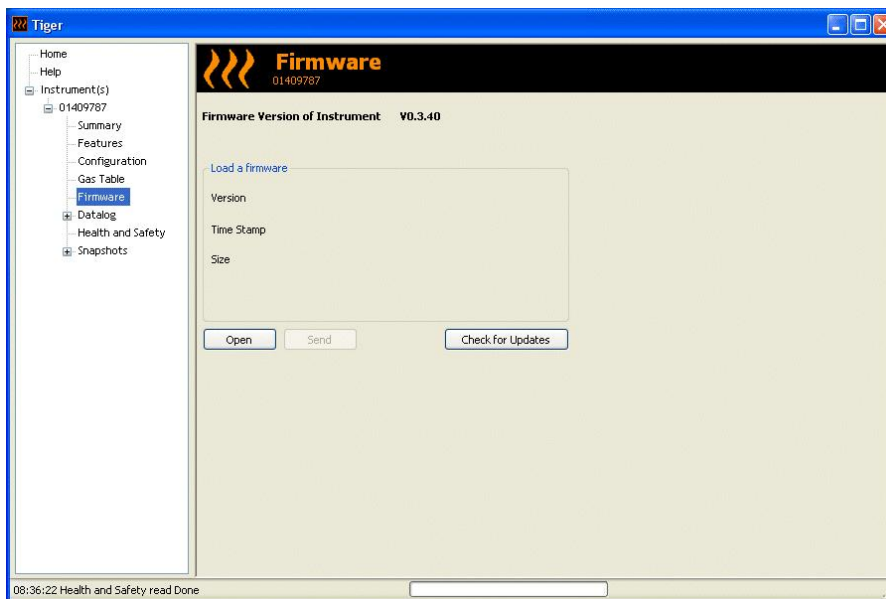

When the upgrade screen appears, click on **Check for updates**

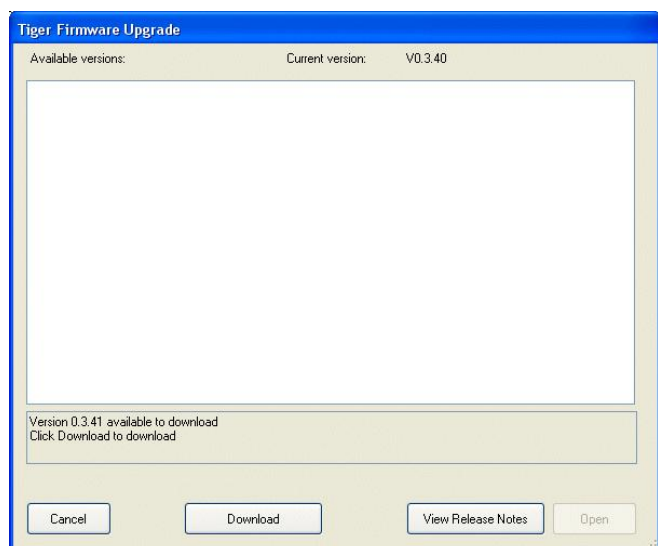

The next screen shows the available upgrades for your instrument
If a higher version than your current version is available click **Download**
Do not attempt to operate your TIGER during the update process.

The firmware on your TIGER will be updated and the new version will be shown on the Firmware screen.



TIGER PC Software (continued)

Downloading data logged readings

Connect your TIGER to your PC as described above on page 19ff. Any fresh data-logged readings will be downloaded as the software reads your TIGER.

Go to the datalog screen and a list of the datalog sessions is presented.

Expand the datalog folder and select the session of interest.

Details of the data collected during that session are presented in numerical and graphical form.

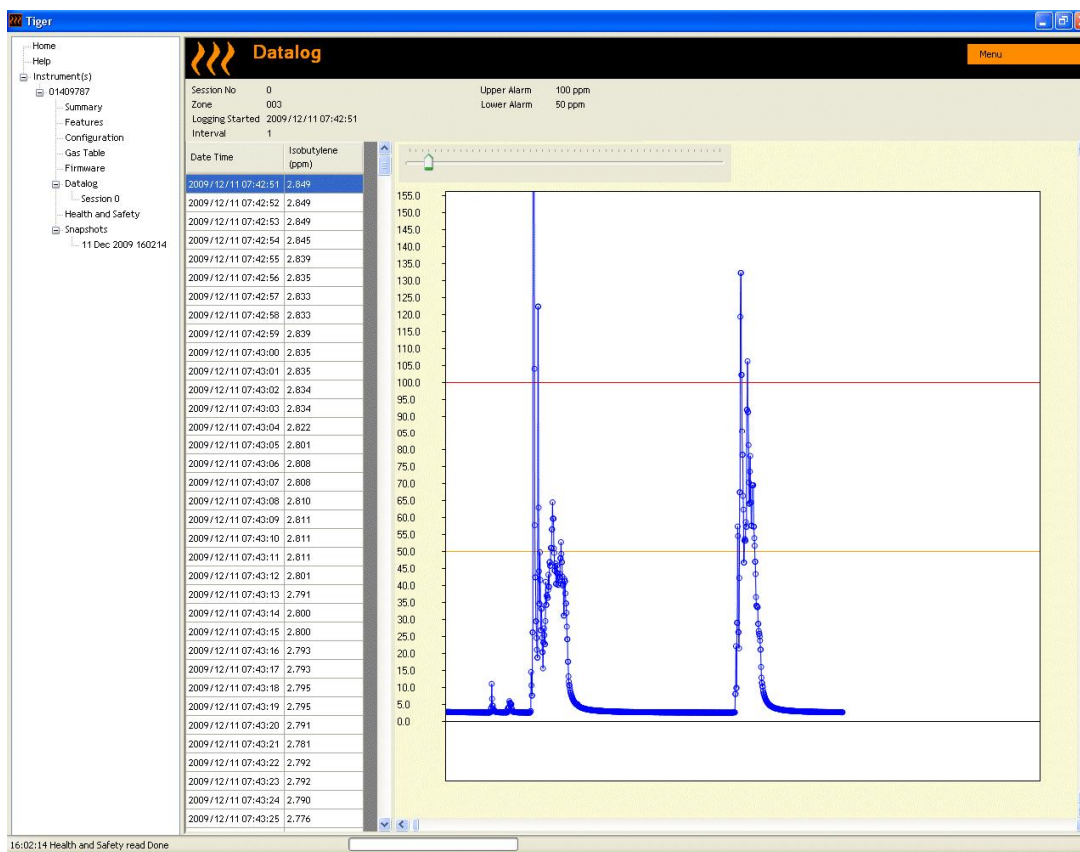

Use the menu function at the top right hand corner of the window to print, export or delete the data.

WARNING: The delete function deletes all logged data from your TIGER. Ensure all valuable data is exported to your PC before selecting 'Delete'.



TIGER PC Software (continued)

The Health & Safety Screen

This screen displays the latest Health & Safety readings held on your TIGER. Click **M**enu then **E**xport to save this data to a file on your computer. The next readings will overwrite the data on your TIGER.



Snapshots

A snapshot records the settings and calibration data on your Tiger at any particular point in time. The Snapshots screen displays a list of all those stored on your PC.

Click **D**elete to remove a selected snapshot.

To restore the stored settings to your TIGER, first ensure that your instrument is fully booted and connected to your PC as detailed on page 19. Ensure that your instrument is in normal Survey mode, is not in an alarm condition and that no datalogging or Health & Safety readings are being collected. Click **R**estore against the relevant snapshot. **Be aware that this process will replace all setup and calibration files.** On the restore screen click **Y**es. When complete, click **C**lose and restart your TIGER. Your TIGER will now be restored to the settings and calibration data stored at the time of that snapshot.

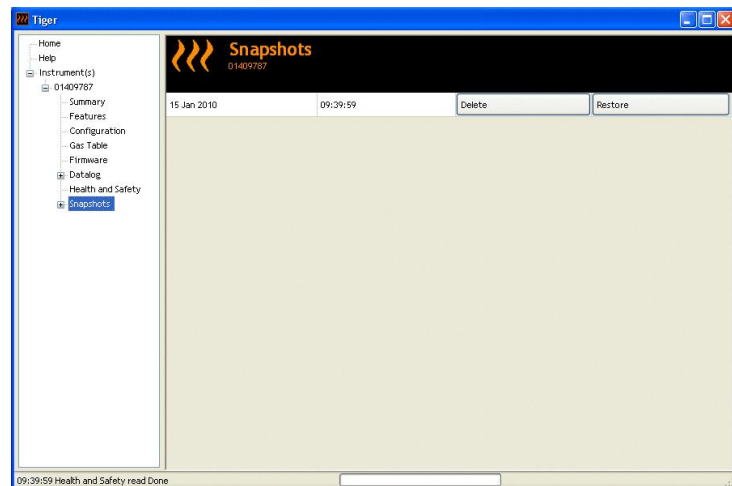

The snapshot menu also allows review of stored data when an instrument is not attached. Expand the menu until the latest or relevant snapshot is displayed. Double-click on the snapshot and all the data stored in that snapshot can be accessed



TIGER PC Software (continued)

Software Disclaimers

Termination of Software Licence

This License is effective until terminated. This License will terminate automatically without notice from Ion Science Ltd if you fail to comply with any provision of this License. Upon termination, you agree to destroy, delete or purge the written materials and all copies of the SOFTWARE, including modified copies, if any.

Disclaimer of Warranty

The SOFTWARE and accompanying materials (including the user's manual) are provided ~~as is~~ without warranty of any kind including the implied warranties of merchantability and fitness for a particular purpose, even if Ion Science Ltd have been advised of that purpose. Furthermore Ion Science Ltd does not warrant, guarantee, or make any representation regarding the use, or the results of the use, of the SOFTWARE or written materials in terms of correctness, accuracy, reliability, current revision, or otherwise. Ion Science Ltd specifically does not warrant the SOFTWARE after you assume operation. If the SOFTWARE or written materials are defective you, not Ion Science Ltd or its dealers, distributors, agents, or employees, assume the entire risk and costs of all necessary servicing, repair, or correction, except as stated below.

Defective CD or Memory Stick

As the only warranty under this Agreement, Ion Science Ltd warrants, to the original Licensee only, that the CD(s) or Memory Stick(s) on which the software is recorded is free from defects in materials and workmanship under normal use and service for a period of ninety (90) days from the date of delivery as evidenced by a copy of the Receipt. This limitation will apply where allowed.

Replacement of Defective CD or Memory Stick

Ion Science Ltd entire liability and the original Licensee's exclusive remedy under this agreement are at the discretion of Ion Science Ltd, to either (a) return of payment as evidenced by a copy of the Receipt, or (b) replacement of the disk or memory stick that does not meet Ion Science Ltd limited warranty and which is returned to Ion Science Ltd with a copy of the Receipt. If failure of the disk or memory stick has resulted from accident, abuse, or misapplication, Ion Science Ltd will have no responsibility to either replace the item or refund payment. Any replacement disk or memory stick will be warranted for the remainder of the original warranty period or thirty (30) days, whichever is longer. This warranty gives you limited, specific legal rights. You may have other rights in some places.

No Right to Rely

No oral or written information or advice given by Ion Science Ltd, its dealers, distributors, agents or employees will create a warranty or in any way increase the scope of the obligations of Ion Science Ltd under this agreement, and you may not rely on any such information or advice.

Limitation of Liability

Ion Science Ltd will not be liable for any direct, indirect, consequential or incidental damages (including damages for loss of business profits, business information, or possibility of such damages). The above limitation will apply where allowed under local laws.

Governing Law

The laws of the United Kingdom govern this Agreement.



Batteries

Note: Ion Science recommends keeping your PhoCheck TIGER on charge at all times when not in use, as batteries can lose power over time.

WARNING:

For reasons of Intrinsic Safety, batteries MUST NOT be charged or replaced within potentially flammable areas. Ensure you are in a SAFE area before carrying out any type of maintenance on your PhoCheck Tiger instrument.

Non-rechargeable battery types to be used

For Intrinsic Safety of T4 rating and reduced risk of explosion only Duracell Procell Alkaline batteries must be used. DO NOT mix old and/or used batteries, nor batteries from different manufacturers.

Rechargeable battery instruments

Ensure the PhoCheck Tiger is charged for at least 7 hours before using it for the first time. To ensure optimum charging the TIGER should be switched off during charging. If left on, the TIGER will take longer to charge, but should not suffer any damage. The TIGER should be charged in a non hazardous environment only.

To charge your TIGER, first connect the charging cradle to the mains, and switch on. A red light will indicate that the charger is ready. Place the TIGER in the charging cradle such that the contacts on the TIGER are aligned with those in the cradle. (There is no need to remove the black rubber Boot from the TIGER during charging.) During charging, the charger will display an orange light. A green light indicates that charging is complete.

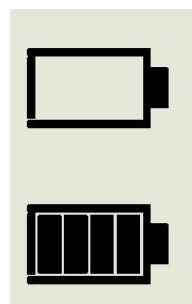

Discharged

Fully Charged

The battery icon on the TIGER will display the level of charge.

NOTE: Only use the charger supplied with your TIGER to charge your instrument.



Batteries (continued)

Replacement of rechargeable battery pack

To replace the battery pack, proceed as follows:

- a. Ensure TIGER is switched Off;
- b. Remove the black rubber Boot from your TIGER (this is most easily achieved by starting at the front end of the instrument (step 4 below));
- c. Release the clip at the rear end of the instrument and lift the battery pack away from the body of the instrument, coincidentally sliding it slightly backwards;
- d. Reverse the procedure to install the replacement pack, ensuring that the Boot is a snug fit around the front of the instrument and the lights are not obscured;
- e. Charge TIGER for seven hours before use.

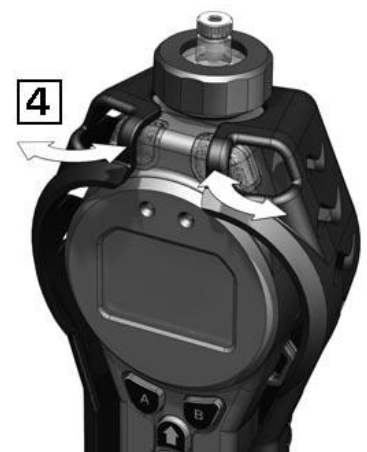
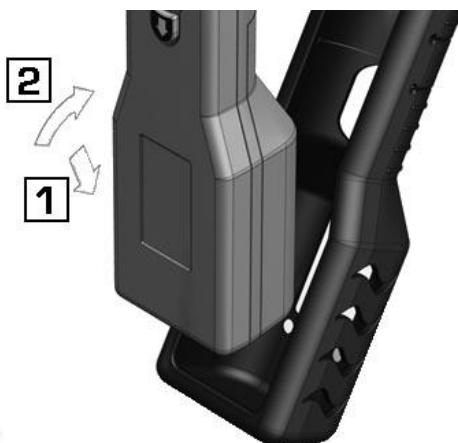
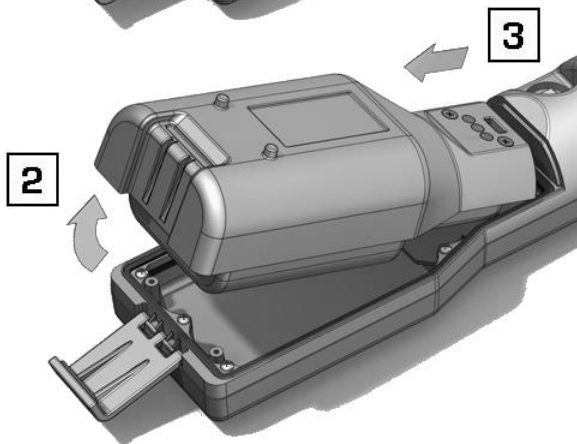
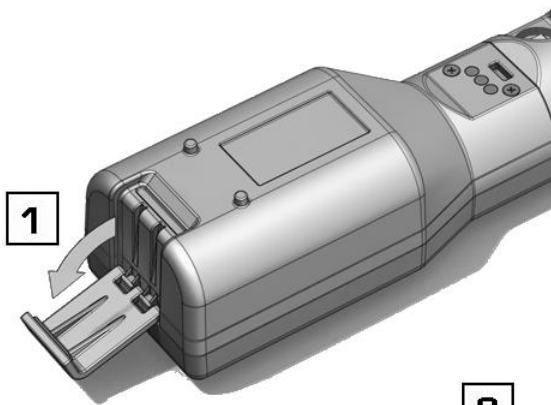



Batteries (continued)

Replacement of Non-rechargeable batteries

- a. Ensure TIGER is switched Off.
- b. Remove the pack as in (b) and (c) above;

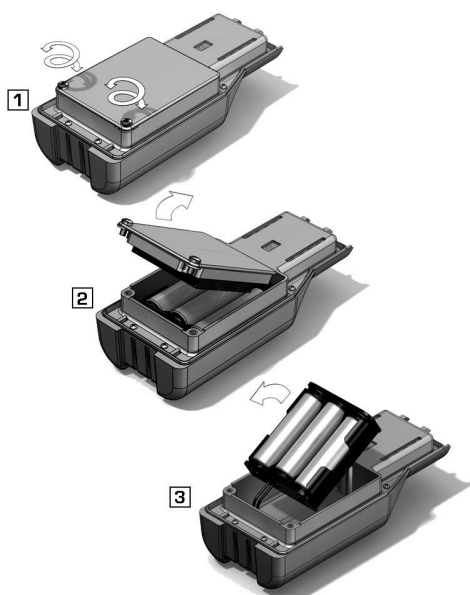

- c. Remove the screws retaining the battery cover and lift it off. This reveals a set of 3 x AA cells contained in a removable battery holder;
- d. Remove the battery holder;
- e. Replace the exhausted batteries;
- f. Check all batteries have the correct polarity before replacing the holder;
- g. Replace the pack as described above.

WARNING: Fitting batteries or connecting the clip with the wrong polarity may result in damage to the instrument!

WARNING: Non-rechargeable batteries **MUST NOT** be replaced in the field. Batteries should be loaded into the battery clip in a safe environment only. Only the assembled battery pack may be changed in the field.

NB: When loading batteries check for correct battery polarity before connecting them.



Diagnostics

Basic faults or diagnostics are presented as symbols. Should a fault occur most can be corrected by pressing ENTER or ESC to clear the fault message. All fault conditions cause the TIGER to alarm.

Pump failure



Pump blocked or pump failure

The flow of gas through the instrument has fallen below 100 cc/minute. Check the probe and filter for signs of blockage. Water or dirt in the probe, a bent probe, dirty filter on the inlet or blockage of the exhaust (finger over hole on the back?) can all cause low flow. If the blockage can be removed, press Escape to clear the alarm. If the fault persists send the instrument to your distributor for service.

Battery dead



Battery low or battery failure

The Tiger will shut down when the battery level falls below 2%. Recharge the battery as instructed on page 29 of this manual ensuring that all connections are sound and the indicator lights on the charger are in order. If the battery fails to charge, fit another battery pack if available. If using alkaline batteries, replace them. If the fault persists send the instrument and charger to your distributor for service.

Lamp out



Lamp failure

The PID lamp has failed to strike (illuminate); this may occur at switch on or during use. Switch the TIGER off and replace the lamp. See Maintenance page 35.

Memory full



Memory cannot receive more data

The data log memory is full. This will only happen if the Log Full box is set to alarm on the TIGER PC configuration screen. Press the Escape key to continue, but the TIGER will no longer continue to log data. Select recycle in TIGER PC and the TIGER will overwrite the oldest data and no alarm will be raised.

System error



Total system failure

The instrument's firmware is corrupted. In the unlikely event of this message appearing, contact Ion Science or your nearest authorised service centre.



Maintenance

Calibration

Ion Science recommends an annual service and calibration for users who require a traceable calibration. During this service the lamp and detector are brought back to factory specifications and new Factory Calibration data is stored.

Due to the linear output of the Ion Science PID detector, a two-point calibration is often adequate. TIGER scales its linear output across a ZERO level (clean air reference) and the SPAN 1 user defined gas concentration. For more exacting requirements, TIGER offers a three-point calibration with a higher SPAN 2 gas concentration.

TIGER offers the options of Factory calibration or Custom calibration. 'Factory calibration' is set by Ion Science during instrument manufacture or on re-calibration. 'Custom calibration' can be set by the instrument user.

For **Factory Calibration** contact Ion Science Ltd. or your distributor.

'Factory' calibration offers a safe set of three-point calibration data. This should be used if the custom calibration fails and will keep the unit working until a good custom calibration is completed.



For **Custom Calibration**, first set up the parameters in TIGER PC - see page 23.

TIGER allows you to custom calibrate using any gas from the Gas Table at any concentration from 10ppm. You will need a cylinder of the selected gas at each of the chosen concentrations. Each cylinder should be regulated for a flow rate above 250ml/min.

Have the cylinder(s) of gas, regulator(s) and the zero carbon filter (included in the Calibration Kit supplied with your TIGER) on hand before starting the procedure. Alternatively a known clean air supply may be used as the zero gas. Please ensure you are familiar with the entire calibration procedure before attempting to calibrate your TIGER.

Note: The calibration of your TIGER must be carried out in a clean air environment. Ensure all parts of the calibration kit are available and ready for use.

Press the Options soft key  on your TIGER to access the adjustable features.

Then use the UP or DOWN key to select calibration.   Press ENTER to confirm selection.

Select Custom Calibration  and press Enter to confirm.

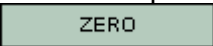
On confirming the selection, the user is presented with a 10 second count down. 

Remove both caps from the carbon filter and attach to the probe of your TIGER. Press ENTER to start the zero countdown. At the end of the count down a tick '✓' will appear, indicating that the Zero has been accepted.

Disconnect the carbon canister and replace the cap ends. The useful life of the carbon canister will be shortened if the canister is open to atmosphere for prolonged periods.





Maintenance (continued)

Press ENTER again and the gas and concentration for Span 1 (previously set up in TIGER PC) are displayed along with a 10 second count-down. **SPAN 1** Attach the Span 1 gas and press ENTER to start the Span 1 countdown. At the end of the count down a tick '✓' will appear, indicating that the Span 1 has been accepted. For two-point calibration, press ENTER and the calibration is complete.

For three-point calibration, press ENTER to display the gas and concentration for Span 2 (previously set up in TIGER PC) along with a 10 second count-down. **SPAN 2** Attach the Span 2 gas and press ENTER to start the Span 2 countdown. At the end of the count down a tick '✓' will appear, indicating that the Span 2 has been accepted. Press ENTER again and the calibration is complete.



Probes

The probe supplied with your TIGER is an 60 mm length of PTFE tubing square cut at both ends. Should the probe become contaminated or damaged, replacement probes may be obtained from your distributor or from Ion Science Ltd. Only PTFE probes should be used and Ion Science can supply alternative lengths if required.

To remove the probe, slacken off the Probe Adaptor at the front end of the Filter Clamp and slide the probe out.

The replacement probe should be gently slid in, ensuring that the instrument end is pushed firmly past the O-ring seal. Tighten the Probe Adaptor to grip the probe, without using undue force.

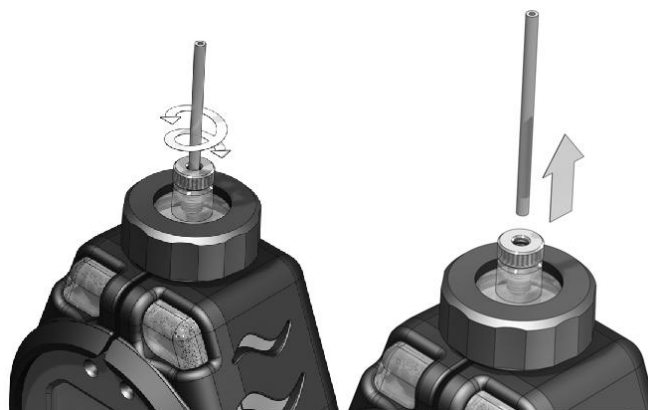

Filter

The filter should be changed after every 100 hours of use. This frequency should be increased for dusty or moisture laden environments or whenever the filter appears dirty when viewed through the transparent upper surface of the Filter Clamp. Filter changing should be conducted in a suitably clean environment, with clean hands and equipment to avoid contamination of the new filter.

To change the filter, unscrew the Filter Housing Cap (item 1 of the Front End Filter Assembly on page 37), lift off the Filter Clamp and O-ring and lift the filter from the TIGER Body by its tab. Carefully place a new filter into the TIGER Body, ensuring that the cross on the tab is facing upwards. **(Under no circumstances should a soiled filter be 'turned over' and re-used.)** Replace the Filter Clamp, ensuring the locating lugs are correctly positioned in the cut-outs in the Tiger Body and that the O-ring is correctly seated. Replace the Filter Housing Cap. Do not over-tighten.



Maintenance (continued)

PID Sensor/Lamp replacement and cleaning

When using your TIGER in conditions of high ambient humidity, the PID may show unexpected readings appearing to increase. This occurs due to dust or other small particles within the detector becoming hydrated with humidity. This causes these particles to conduct a signal between the electrodes. The problem can be resolved by the user in the field using the procedure below and a can of computer duster air.

In normal use the lamp should be cleaned after every 100 hours of use (based on 30 ppm for 100 hours). Reduce this if TIGER is used in heavily gas contaminated environments. Please note that some esters, amines and halogenated compounds may accelerate window fouling; in these cases cleaning may be required after every 20 hours of use. Cleaning frequency will also depend upon alarm levels set and prevailing environmental conditions.

CAUTION!

The TIGER is a sensitive detector. Internal components must be handled with clean hands and clean tools. The TIGER lamp is fragile. Handle with great care. Never touch the window and do not drop!!

To remove the Mini PID sensor for cleaning or lamp replacement, first ensure that the TIGER is turned off and that you are in a clean environment such that the sensor parts will not be contaminated by dust, oil or grease. Remove the sensor cover (A5 on page 37). The centre screw may be turned with a small coin or a suitable flat bladed screwdriver.



Ensure that the sensor seal (9), on the inside of the sensor cover is not disturbed.

Carefully lift the Mini PID Sensor (A6) from the TIGER body, ensuring that the two Inlet/Outlet Seals (10) remain in place in the TIGER body.

Using the special tool provided, locate its prongs in the slots in the side of the Sensor body. Using the forefinger to restrain the sensor, (the internal parts are spring-loaded and careless disassembly will leave you hunting for the spring!) squeeze the tool to release the lamp housing.



The lamp may now be removed.

To replace the lamp or install a new one, reverse the procedure, ensuring the seals are all in place. When replacing the sensor cover ensure that the markers are aligned correctly and that the cover is a snug fit.

The instrument **MUST** be re-calibrated after fitting a replacement or cleaned lamp.

WARNING! NEVER REFIT A DAMAGED LAMP!



Maintenance (continued)

Lamp Cleaning

The TIGER PID relies on an ultraviolet light source ionising VOC gases as they pass across the lamp window. This process may result in a very fine layer of contamination appearing on the detector window that must be removed on a regular basis.

CAUTION!

The TIGER is a sensitive detector. Internal components must be handled with clean hands and clean tools. The TIGER lamp is fragile. Handle with great care!

First ensure that the TIGER is turned off and that you are in a clean environment such that the sensor parts will not be contaminated by dust, oil or grease.

Remove the lamp as detailed above.

Inspection of the lamp may reveal a layer of contamination on the detection window that presents itself as a blue hue. To check for confirmation, hold the lamp in front of a light source and look across the window surface. Clean the window using the cleaning kit supplied.

USE of PID lamp cleaning kit A-31063

The vial of cleaning compound contains Aluminium Oxide as a very fine powder (CAS Number 1344-28-1). A full material safety data sheet MSDS is available on request from Ion science ltd. The key issues are listed below:

Hazard identification:

- May cause irritation of respiratory tract and eyes.

Handling:

- Do not breathe vapour/dust. Avoid contact with skin, eyes and clothing;
- Wear suitable protective clothing;
- Follow industrial hygiene practices: Wash face and hands thoroughly with soap and water after use and before eating, drinking, smoking or applying cosmetics;
- The Compound has a TVL(TWA) of 10 mg/m³.

Storage:

- Keep container closed to prevent water adsorption and contamination.

To clean the lamp:

1. Open the vial of Aluminium Oxide polishing compound. With a clean cotton bud collect a small amount of compound;
2. Use this cotton bud to polish the PID lamp window. Use a circular action applying light pressure to clean the lamp window. Never touch the lamp window with fingers;
3. Continue polishing until an audible squeaking is made by the cotton bud with compound moving over the window surface (usually within fifteen seconds);
4. Remove the residual powder with short blast of air from the can of air duster;
5. The instrument MUST now be re-calibrated.





TIGER Parts

TIGER Main Assembly

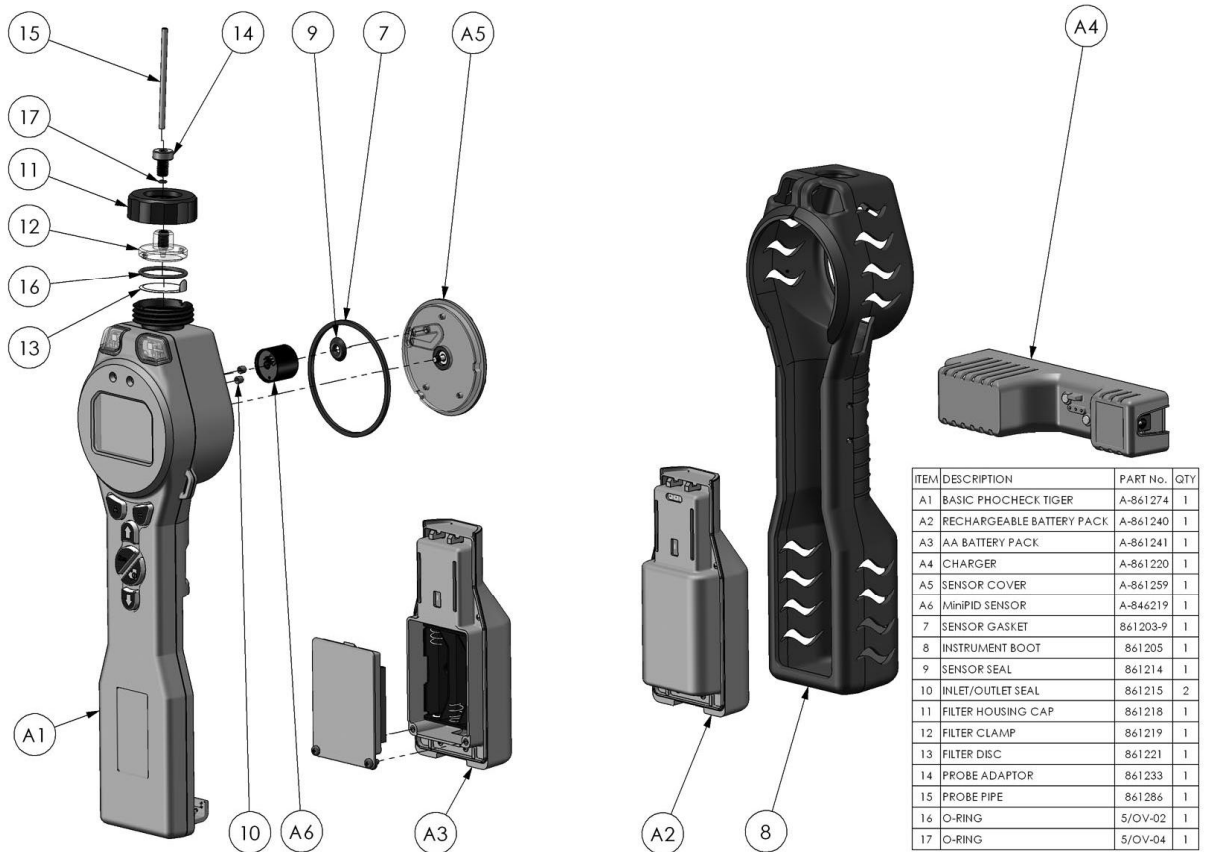

ITEM	DESCRIPTION	PART No.	QTY
A1	BASIC PHOCHECK TIGER	A-861274	1
A2	RECHARGEABLE BATTERY PACK	A-861240	1
A3	AA BATTERY PACK	A-861241	1
A4	CHARGER	A-861220	1
A5	SENSOR COVER	A-861259	1
A6	MiniPID SENSOR	A-846219	1
7	SENSOR GASKET	861203-9	1
8	INSTRUMENT BOOT	861205	1
9	SENSOR SEAL	861214	1
10	INLET/OUTLET SEAL	861215	2
11	FILTER HOUSING CAP	861218	1
12	FILTER CLAMP	861219	1
13	FILTER DISC	861221	1
14	PROBE ADAPTOR	861233	1
15	PROBE PIPE	861286	1
16	O-RING	5/OV-02	1
17	O-RING	5/OV-04	1

Front End Filter Assembly

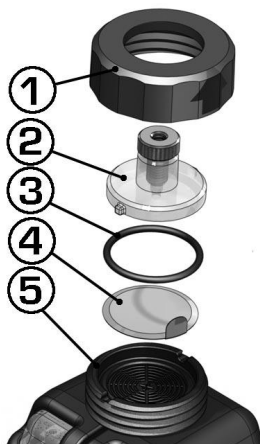

Item	Description	Part No.
1	Filter housing cap	861218
2	Filter clamp	861219
3	O-ring	5/OV-02
4	Filter disc	861221
5	Tiger body	A-861274



Accessories

Ion Science has developed an exclusive range of high quality accessories to compliment the PhoCheck TIGER. Please see a selection of these below:

Part Number	Accessory Description
1/jawu-01	2.1mm DC jack - cigar lighter plug Car Charger Lead
846216	Removal tool Min PID stack
861205	Protective, Removable rubber boot
861230	USB Cable - Angled B Connector
861413	5m Extension Hose
861414	10m Extension Hose
861415	Diluter
A-31063	PID lamp cleaning kit
A-830206	Decontamination Bag (10 Off)
A-861269	Explorer Case - Phocheck Tiger
A-861272	Accessory Kit - Rechargeable Battery
A-861273	Accessory Kit - Alkaline Battery
A-861400	Drager Tube Holder Assembly
A-861406	Flexible Probe Assembly
A-861416	Charging/Calibration Dock
A-861418	Calibration Kit
LA4SB600	Series 4 Lamp PPB (packed)
LA4SM600	Series 4 Lamp PPM (packed)

Contact Ion Science or your local Distributor for more information.



Service Options

Ion Science Ltd is pleased to offer a number of service options on your PhoCheck TIGER product range that allow you to choose the instrument cover that best suits your needs.

At Ion Science we recommend that all of our gas detection instruments be returned for service and factory calibration once every 12 months.

Contact Ion Science or your local distributor for service options in your area.

Find your local distributor by visiting: www.ionscience.com .



Technical Specifications

Response time	1 ppb - 10,000 ppm	T90 < 2 second
Accuracy	+/- 5% displayed reading +/- one digit*	
Linearity	+/- 5% displayed reading +/- one digit*	
Battery	Lithium ion	30 hours
	Alkaline (Duracell Procell MN1500)	12 hours
Data log	Including date / time	120,000
Alarm visual	Flashing Red & Amber LED	
Alarm audible	95 dBA @ 30 cm	
Flow Rate	220 ml/min	
Temperature	Operating	-20 to 60 °C (- 4 to 140 °F)
	Storage	-25 to 60 °C (-13 to 140 °F)
	Certified to	-15 to 60 °C (- 5 to 140 °F)
Dimensions	Instrument	340 x 90 x 60 mm
Weight	Instrument	0.720 kg (1.6 lb)
Materials	Instrument	Anti-static PC/ABS (Polycarbonate/ Acrylonitrile Butadiene Styrene)
	Rubber Boot	Anti-static TPE (Thermoplastic Polyolefin Elastomeric)

* assuming consistent ambient conditions



Manual History

Issue	Amendment	Issue Date	Instrument Firmware	PC Software
Phocheck TIGER issue 1.0	First issue	15 Jan 2010	Version 0.3.40	Version 1.0.0.18

