

Geosub 2 Pump & Controller

Installation and Operation Manual



Table of Contents

Section 1: System Description	4
Section 2: System Installation	6
Section 3: System Operation	10
Section 4: System Maintenance	12
Section 5: System Troubleshooting	25
Section 6: System Specifications	27
Section 7: Replacement Parts List	30
EC Declaration of Conformity	36
The Warranty	37

DOCUMENTATION CONVENTIONS

This document uses the following conventions to present information:



An exclamation point icon indicates a **WARNING** of a situation or condition that could lead to personal injury or death. You should not proceed until you read and thoroughly understand the **WARNING** message.

WARNING



A raised hand icon indicates **CAUTION** information that relates to a situation or condition that could lead to equipment malfunction or damage. You should not proceed until you read and thoroughly understand the **CAUTION** message.

CAUTION



A note icon indicates **NOTE** information. Notes provide additional or supplementary information about an activity or concept.

NOTE



NOTICES

In order to ensure that your Geosub 2 Controller has a long service life and operates properly, adhere to the cautions below and read this manual before use.

Disconnect from power source when not in use.

Controller power input source must not exceed maximum ratings.

Controller must be wired to a negative ground system.

Controller may not operate properly with excess wiring not supplied by manufacturer.

Avoid spraying fluid directly at controller.

Never submerge controller.

Avoid pulling on wires to unplug controller wiring.

Avoid using controller with obvious physical damage.

To prevent controller damage, avoid dropping controller.



The Geosub 2 Pump and Geosub 2 Controller cannot be made dangerous or unsafe as a result of failure due to EMC interference.



Do not operate this equipment if it has visible signs of significant physical damage other than normal wear and tear.

Notice for consumers in Europe:

This symbol indicates that this product is to be collected separately.

The following apply only to users in European countries:

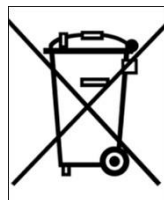

- This product is designated for separate collection at an appropriate collection point. Do not dispose of as household waste.
- For more information, contact the seller or the local authorities in charge of waste management.

Section 1: System Description

Watt Controller Function and Theory

This Geosub 2 Controller is designed specifically for use with Geotech's Geosub 2 Pump. It provides a safe conditioned variable DC output power from an AC power source. Built-in sensing gives the operator accurate and precise control over the pump during sampling events. Efficient operation allows for extended field operation using portable AC generator equipment such as a gasoline-powered generator. An average 1000-Watt gasoline powered generator with 1 gallon of gasoline can operate the Geosub 2 Controller and Geosub 2 sampling pump at full power for up to 18 hours.



Be sure to read and understand your portable generator User Manual for proper installation operation, and earth-grounding instructions.

An easy to use programmable user interface with bright display offers precise control over water flow during ground water sampling events. Site-specific settings can easily be stored and recalled for repeatable efficiency during sampling events. Rugged construction and portability make connecting, installation and setup a breeze.

Pump Function and Theory

Geotech's Geosub 2 Pump is a fully submersible environmental pump designed specifically for use in ground water sampling. All wetted parts are made from high quality inert materials so sample integrity is not affected during sampling. The Geosub 2 flow rate can be adjusted to change from well purge flow rates to low flow sampling rates. Figure 1-1 contains a graph for the flow rates and operating depths.

Drop Tube Intake System

Geotech's optional Drop Tube Intake System allows you to easily relocate the pump intake well beyond the depth limitations of the pump. As long as the pump remains submerged, you can effectively and economically low flow a sample from a deeper point within the well's screened section. See Figure 2-1.

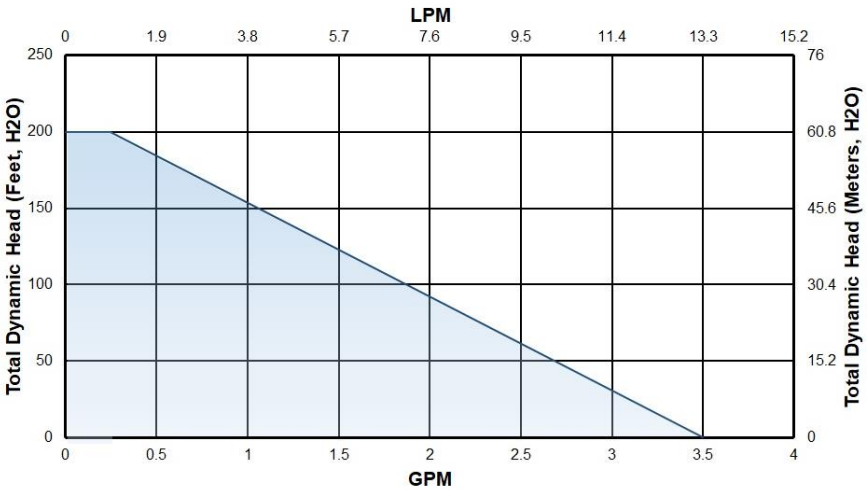





Figure 1-1: Pump Performance Chart

Pump Speed Control Operation and Theory

Pump speed control is achieved by pressing the up or down button during run time. The number can be adjusted from 1 to 255 in increments of one unit. The adjustments can be made one at a time by pressing the  or  button once or can be changed rapidly by holding the  or  button. This number is representative of power output. Most conditions do not allow for the full 1 to 255 point range of use. At the upper end of the scale, the controller automatically prevents the user from overpowering a pump. The controller indicates when max power has been reached and prevents the user from increasing the output further.

In most cases, the usable range of control will be a 100 point window somewhere within the 1 to 255 point range. In general, the longer the cable being used the higher the speed set point and vice versa. Other application specific conditions such as head pressure and tubing size will also affect the speed set point window of operation.



When adjusting the speed at the lower end of the 1 to 255 point scale, the pump may shut down. This fault condition is most obvious when a system has high flow, low pressure, and long cable.

Minor Adjustments to Flow Rate

Small increments to flow rate can be made by raising or lowering the height of the sampling tube. If the sample rate is too low or too high, adjust the pump speed on the controller, and then adjust the height of the discharge tube.

- If the flow rate is too high, raise the discharge tubing.
- If the flow rate is too low, lower the discharge tubing.

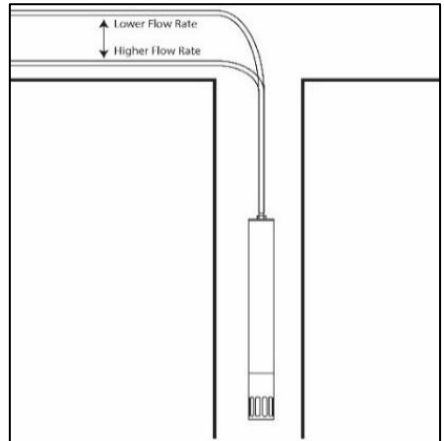

Figure 1-2: Minor Adjustments to Flow Rate

Section 2: System Installation



READ BEFORE PROCEEDING ANY FURTHER



The Geosub 2 Controller operates on high voltages supplied by a portable generator or grid-supplied main power. Care must be taken at all times to avoid electrical shock. Do not subject the Geosub 2 Controller to contact with water. A grounding rod or stake driven directly into moist earth must be installed and electrically connected if using a portable generator larger than 2000 Watts.

The Geosub 2 Controller operation should be performed only by qualified persons. Reading this manual is essential for operating this equipment safely. If, after reading this manual, you are still unsure about the operation of this equipment contact Geotech for further information and training.

The Geosub 2 Controller stores energy for short periods even after power has been removed. The Geosub 2 Controller has no field serviceable components and should never be opened by an unqualified person.

The Geosub 2 Controller has been specifically designed for use with Geotech's Geosub 2 Pump **ONLY!** Care must be taken when operating any equipment that operates on main voltage. Contact Geotech for service or repair. (See *Section 5, System Troubleshooting*, for common fault conditions and suggestions on how to correct issues).



Verify intended power source matches the model supply specifications of the Geosub 2 Controller in use. Geosub 2 Controllers are available in 120VAC and 230VAC 50/60HZ models and must be powered accordingly.



Damage will result if controllers are connected to incorrect input power supply. Once input power source has been verified, connect input power cable to the Geosub 2 Controller, and then connect cable to power source, i.e. portable generator or main grid power.

Connect input power cable. The display will light up, and after a short startup sequence is executed, a message will display indicating the controller status.

Attach the pump to the controller using factory-installed connectors on both the Geosub 2 Controller and pump cable. Use of any other connectors or method of attaching pump to controller will cause shock and or fire hazard.

When the status display shows, “Main Menu” proceed to *Section 3: System Operation*. If display is blank, shows a fault or error condition, proceed to *Section 5: System Trouble Shooting*.

Drop Tube Intake Assembly Installation and Operation

The optional Drop Tube Intake Assembly is designed to allow you to relocate the Geosub 2 Pump intake to a deeper screened part of the well. The Geosub 2 Pump can either be built with a Drop Tube Intake and the necessary tubing length attached, or the Drop Tube Intake Assembly parts can be added to an existing pump at a later time. An example of all Drop Tube Intake parts can be found in *Section 7: Replacement Parts List*.

When using a Drop Tube Intake with your Geosub 2 Pump, the pump must be placed below the static water line, as shown in Figure 2-1. Using a Drop Tube Intake can keep the pump at an optimum depth to maximize performance and the assembly is easily adaptable in the field.



Drop Tube tubing lengths are custom to each well. When using or re-using poly tubing, it is suggested that small hose clamps be attached at the two hose barbs to prevent the accidental detachment of the drop tube assembly within the well.

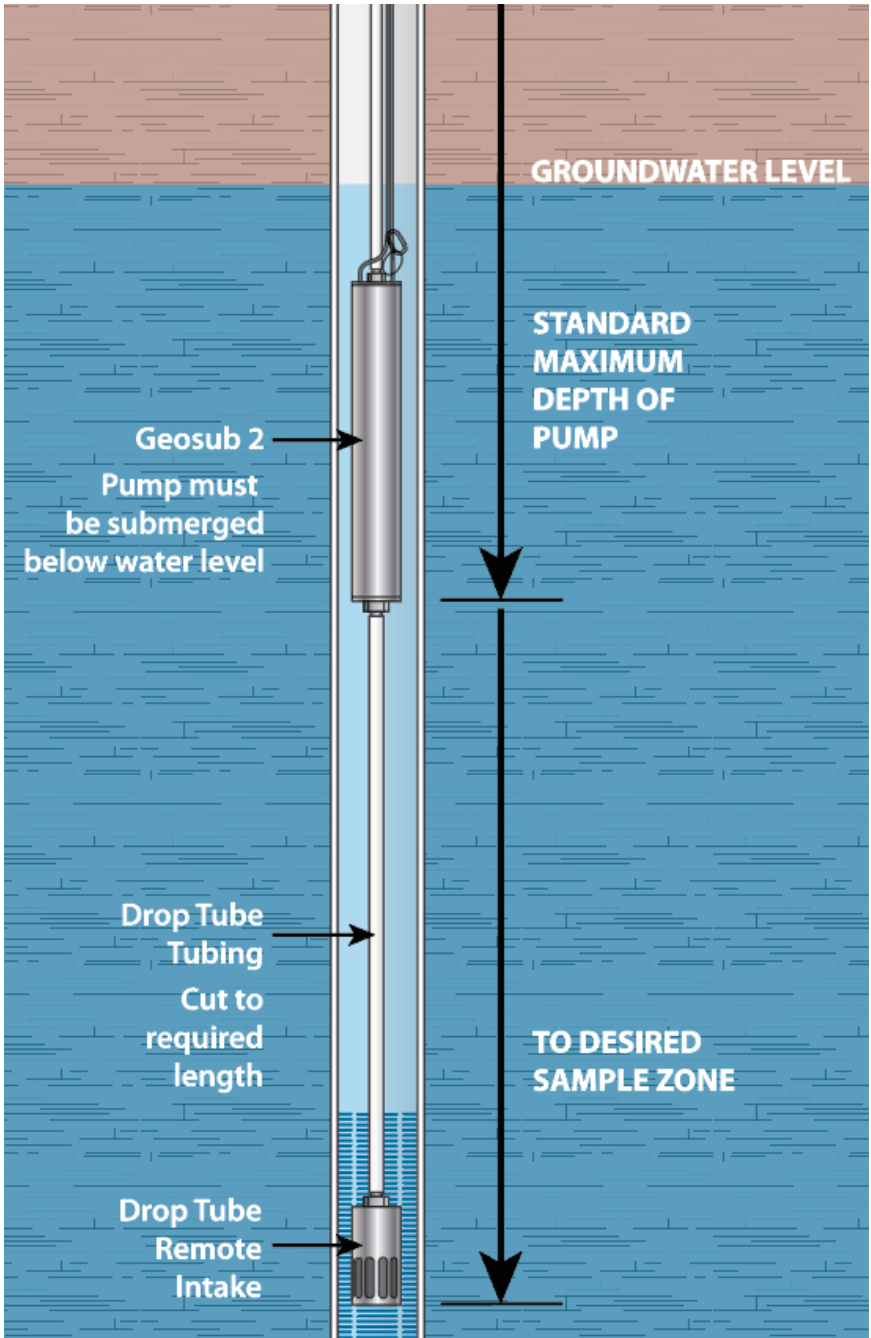

Figure 2-1: Geosub 2 Pump with Drop Tube Assembly in Well

Section 3: System Operation



When disconnecting power, it may take up to 2 minutes for complete shutdown.

Key Pad Description:



This arrow is used to configure well option, raise the speed of the pump, and adjust settings in the program.



This arrow is used to lower pump speed and adjust other settings of the program.



This button will return you to the MAIN MENU from anywhere in the program.



This button is used to start the pump, confirm selections, and advance to the next section of the program.

Basic Operation



- Plug power cord into controller.
- Plug power cord into AC supply outlet.
- Wait for initialization sequence to complete.
- From the MAIN MENU:

- Press  to start the pump with the default settings.

```
Rt=START      #nn
```

- Wait for soft start sequence to complete.

```
STARTING      #nn  
PLEASE WAIT
```

- Press the  or  buttons to adjust pump speed to achieve desired flow rate.
- Pump water at desired pump speed.

- Press  to stop and return to the MAIN MENU.

Display Descriptions

- MAIN MENU. Press  button to start the pump with the default settings.

Rt=START #nn

- This message is shown after pressing the  button from the MAIN MENU.

STARTING #nn
PLEASE WAIT

- This is the run time message shown during normal operation:

PUMPING WELL #nn
nnn

- This message is shown when the operator has chosen to exit any runtime menu and is returning to the Main Menu.

RESETTING PUMP
STANDBY

- May indicate major system fault. Disconnect power and allow controller to reset.

INVALID
MODE

- If message should return, contact the Geotech service department.

Section 4: System Maintenance



All of the procedures called out within this section are provided by the Geotech Service Department. Contact your nearest Sales Representative to have your Geosub 2 Pump and Controller professionally inspected and serviced.

Controller:

Clean the controller as needed with mild soap and water on a cloth. Do not use abrasive cleaners or solvents. Do not spray with water or any other liquid or pressured solvents. Use an air source to blow water out of all cable connections as needed.

Pump:

Clean the pump between sampling events using detergent and water. Cleaning the pump between uses is important to keep the impeller from getting stuck in place, making it impossible to pump water. Fine grit and particulate matter can cause threads and tight fitting parts to become extremely difficult to disassemble if left to dry in the pump after use. The pump can be disassembled completely for decontamination and cleaning.

Regularly check the conditions of the pump's o-rings.

There is one o-ring sealing the outer housing to the top cap, four o-rings sealing the inner housing to the top cap and motor, one o-ring sealing the motor cavity connector, and two captured o-rings sealing the wire lead through the top cap (remove socket head cap screws to access). The o-ring sealing the motor cavity connector should be replaced if the control module is replaced. Damaged o-rings should be promptly replaced before next use.



The Geosub 2 Pump must be thoroughly cleaned and dried between uses, especially prior to storage. Failure to thoroughly clean and dry the pump may result in corrosion and permanent damage to the equipment, making the pump unusable.

Contact your Geotech Sales Representative for Replacement Parts covered in this manual.

Pump Disassembly

Follow the instructions below to disassemble the pump:

1. Holding the top cap, unscrew the top cap from the outer housing.



- If the cap is difficult to remove, use a crescent wrench.



2. Remove the inner housing.



3. Pull the top cap from the inner housing.
 - Do not use any tools to remove the top cap.
 - This may cause damage to the threads.



4. Disconnect the connector.



5. Use an appropriate tool to lightly twist and then pull the motor impeller, to remove it. The Geosub 2 assembly/disassembly tool is recommended to avoid damage to the impeller or internal wires.



6. Remove all components and make repairs and replacements as needed.



Pump Reassembly

After making needed repairs, use the following steps to reassemble the pump:

1. Spiral the wires on the motor control module.
 - Do not twist wires.



2. From the bottom of the housing, insert the motor control module.

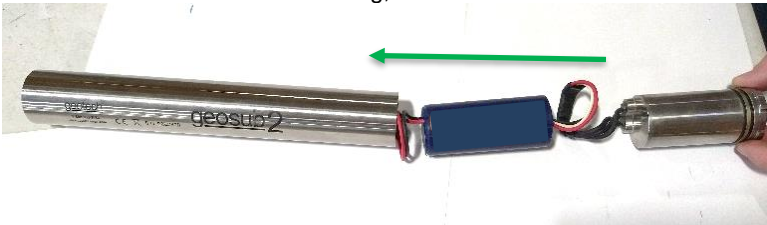

3. Press the impeller into the inner housing.
 - Do not press the impeller against any hard surfaces, this will damage the impeller. The Geosub 2 assembly/disassembly tool can assist with this process.
 - If needed, lubricate the O-rings with clean water.



4. Pull the connector through the top and reconnect.
 - Ensure the compression connector has a secure connection.
5. Press the top cap into the inner housing.
 - Lubricate the O-rings with clean water as needed.
 - Do not press the cap against any surfaces.



6. Insert inner housing with cap into the outer housing.



7. Slightly twist cap to secure in place.



Maintaining and Cleaning the Screened Intake

For optimal pump performance, it is recommended that the Screened Intake on the Geosub 2 Pump be regularly cleaned. If the pump is being consistently used in particle-heavy liquids, it is best to clean the intake after each use. Allowing mud or sand to dry and build up on the screen intake will result in decreased pump performance.

Tools needed:

- Flathead screwdriver, small
- Pick or hook tool

Power down and disconnect the pump from the controller, drain residual liquid. Work on a solid surface where no parts can fall out of sight.

1. Use a flathead screwdriver to remove the snap ring from its seat; there is a relief on the outer edge of the snap ring where the flathead can gain leverage without damaging the retaining disc.
2. Use a pick or hook tool along the outside of the retaining disc to dislodge from its seat.
3. Use a pick or hook tool on the inside of the screened mesh and gently pull down and out of the housing.



DO NOT PUSH OR DENT THE SCREEN, DOING SO WILL RENDER THE SCREEN DEFECTIVE

4. Rinse all components, including slots on outer housing, in clean water. Heavy buildup should be soaked and released with a wire brush. Assemble in reverse order, ensuring that the screen intake is in good condition and that all components fit securely.

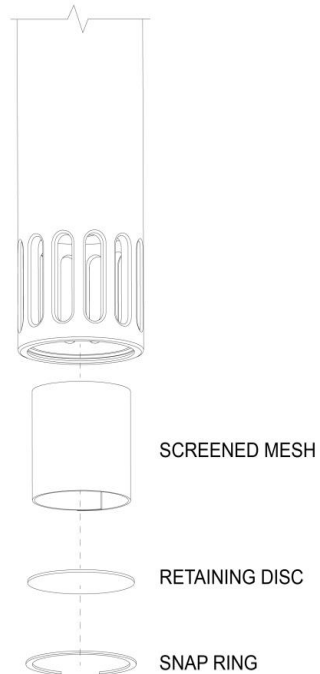

Figure 4-1: Screened Intake

This maintenance should also be performed on the Geosub 2 pumps equipped with a drop tube intake.

Compression connection

The Geosub 2 will come from Geotech with a permanent potted connection. A compression connection will be used when replacement/repair is required.

Reference *Section 7: Replacement Parts List*, and Figure 7-1 and Figure 7-2 for part numbers.

To replace female connector on reel end:

1. Cut and remove existing connector and any damaged cable.
2. Measure and mark 12" from the end of the Geosub 2 cable.



3. Using an X-acto blade (or similar blade), score the cable between safety cable and conductors, on each side of the safety cable.
 - Do not cut or damage conductors or safety cable.



4. Flip cable over and repeat, scoring each side of cable.

5. Score cable until cable neatly separates.

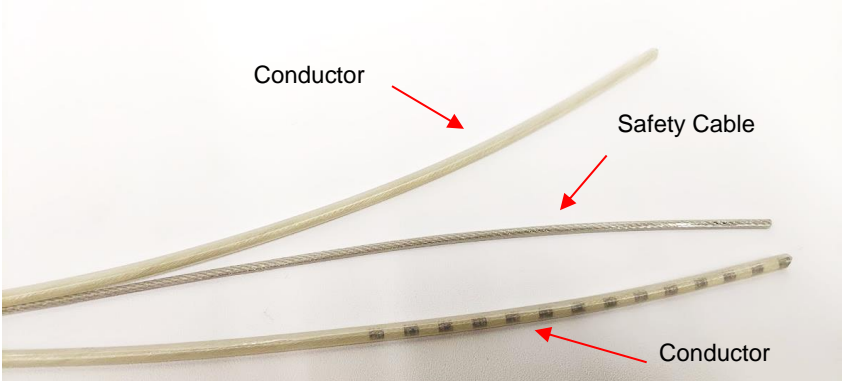

6. Pull conductor wires through the eye bolt then through the top cap.
- Leave 3.5" of cable (cut ends) extending past the bottom top cap.
 - Run conductors through the 3.3mm x 2.4mm Buna o-rings and place o-rings in the grooves in the top cap.



7. Pull conductor wires through the bottom cap.
 - Ensure the bottom cap screw hole are aligned with the screw holes on the top cap.



8. Secure bottom cap in place using the three (3) 6-32 x 3/8 screws.
9. Run the safety cable through the eye bolt, back up through the cable clamp and secure.
10. Place the connector nut, with threads facing the cut side, over the wires.
11. Place wire seal over the wires (ensure the correct orientation of the wires)
12. Pull wires through the connector housing.
 - The black marked wire goes through the raised side of the housing.
 - The unmarked wire goes through the pocket side of the housing.

Raised Side

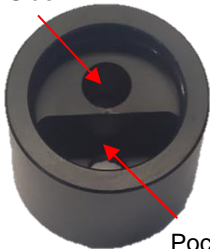

Pocket Side

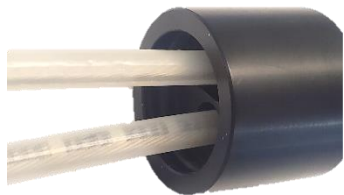

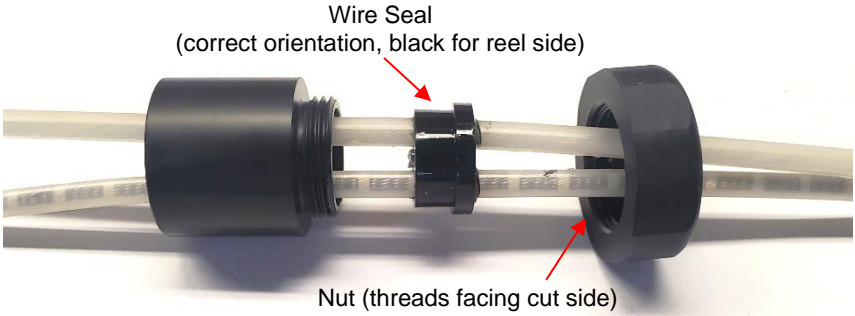

13. Strip wires 3/16" using the 12AWG setting on wire strippers and tin wires.



14. Solder wires to female pin to the stripped wires.

- Do not over-solder the wires.
- If the pins are over-soldered, they will not fit into the housing.



15. Pull wires back through housing so that the pins are slightly below the step.
 - If you have the Geotech pin insertion tool, use it to push the connectors in, otherwise they will need to be pulled through. A solid solder connection will ensure this can be done.
 - The pins need to be below the step of the housing.



Pins slightly below step



16. Push wire seal into housing cavity.
17. Tighten nut to compress the grommet.
 - If needed, lubricate the wire seal with deionized water or a lubricant that is approved for your application prior to tightening compression nut.
18. Place o-ring in groove, lubricate if needed.

O-ring



To replace male connector on motor end:

1. Cut and remove existing connector and any damaged wire.
2. Place nut, with threads facing the cut end, over the wires.
3. Place wire seal over the wires (ensure the correct orientation of the wires)
 - The wire seal will be blue on the motor side.
4. Pull wires through housing.
 - The black wires goes through the low step side of the housing.
 - The red wire goes through the other side of the housing.



5. Strip wires 3/16" using 14AWG wire strippers then tin the wires.



6. Solder male pin connectors to wires.
 - Do not over-solder pins.
 - If pins are over-soldered, they will not fit into the housing.



7. Pull wires back through the housing so that the pin is slightly below the tall step of the housing.
 - If you have the Geotech pin insertion tool, use it to push the connectors in, otherwise they will need to be pulled through. A solid solder connection will ensure this can be done.
 - The pins should be slightly below the tall step of the housing.
8. Push wire seal into the housing cavity.
9. Tighten on the compression nut to compress the wire seal.
 - If needed, lubricate the wire seal with deionized water or a lubricant that is approved for your application prior to tightening compression nut.

Pin slightly
below tall step
of housing.

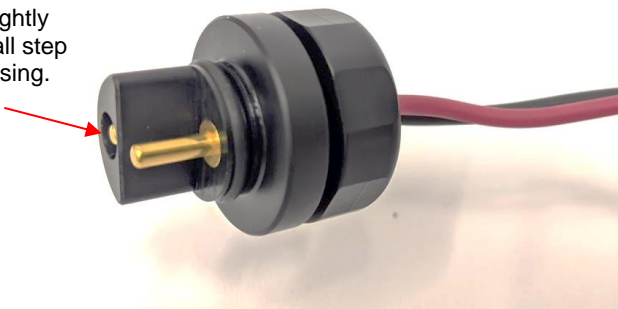

Section 5: System Troubleshooting



DO NOT OPERATE THE GEOSUB 2 CONTROLLER IF IT HAS BEEN DAMAGED, BROKEN, SMASHED, OR EXCESSIVELY WORN. BROKEN COMPONENTS POSE A SEVERE THREAT TO THE SAFETY OF THE OPERATOR AND HIS OR HER ENVIRONMENT. CONTACT GEOTECH SERVICE AT 1-800-833-7958 FOR ANY SERVICE OR REPAIR NEEDS.

Geotech's Geosub 2 Controller has been designed and manufactured to provide a long and trouble-free life under field use conditions. In general, the display will indicate any fault conditions that can occur during use.

Problem: The display is not showing anything.

Solutions:

1. Verify the input power is correct and at the correct voltage. If unsure, have a qualified electrician verify main power source.
2. With the unit plugged in to a known good power source, and the pump attached, press the UP button. If the display has simply gone out: Lift the pump out of the well, if you hear a chirp sequence coming from the pump upon start up, followed by the sound of the impeller running, then the display needs to be replaced. Press the main menu key, deploy the pump, and press the UP button again. Run the pump 'blind' using the up and down arrows to control flow. To stop the pump, use the main menu key. Contact Geotech Service to have the display repaired.
3. Disconnect the power cord from both the power outlet and the controller. Visually inspect the cord and plug ends for damage. If damaged, do not use. Visually inspect the power receptacle on the controller, if damaged do not attempt to repair. Contact Geotech Service for repairs.

Problem: The display says "NO PUMP ATTACHED"

Solutions:

1. Unplug unit and wait 1-2 minutes, then restart.
2. If pump is submerged under a significant amount of water, program the controller to start at a higher pump speed set point.
3. Inspect the cable for damage and make sure the connections are secure inside the pump. Verify that everything is connected and there is no cable damage.
4. If using preset well settings, increase your pump start up set speed. For example if you had been trying a set speed of 30, try using 50 instead.

Problem: The display says “OUTPUT FAULT OVER CURRENT”

Solutions:

- Inspect the cable for damage. If no damage is found, disconnect the pump from the controller and press the  button to start the pump. If the display says “OUTPUT FAULT” then the controller is internally damaged and must be returned to Geotech for repairs.
- If the controller display indicates “NO PUMP ATTACHED”, then the problem is in the cable or pump assembly and the controller is working.
- If there is no cable damage then the problem could be in the pump. Use an ohmmeter to measure the input terminals to the pump. If the measurement is less than 100 ohms the potted control board inside the pump must be returned to Geotech Service for repair or replacement. If the measurement is greater than 100 ohms then inspect the motor assembly for bad bearings or debris preventing the impeller from turning.

Problem: Pump impeller will not turn and controller indicates “NO PUMP ATTACHED”

Solutions:

- If mud, dirt, or sand has dried onto the impeller, soak in water and try to remove debris. If the impeller is free of such debris then one of the bearings may be worn out and you must replace the motor/impeller assembly Geotech Part Number 51200089 (200’ Motor Lead model).
- Check for quality lead connections along entire system assembly. Inspect and repair the 2-pin connections from Controller to Reel and from Reel to Pump.

If you are experiencing other problems than mentioned above, please call Geotech Technical Support for immediate assistance, (800) 833-7958.

Section 6: System Specifications

Geotech has taken steps to remove all polyflouroalkyl substances (PFAS) materials from the Geosub 2. Wetted materials are made from stainless steel, polyethelyne, and Buna-N.

Controller specifications

Model: Watt Geosub 2 Controller
IP rating: IP51 when open and operating
IP67 when closed. ATA300



Maximum Input power 81200034: 100-130 Volts AC
4.2 amps nominal full load 115 Volts AC
50/60 HZ 310 Watts
Maximum Input power 81200035: 200-250 Volts AC
2.1 amps nominal full load 230 Volts AC
50/60 HZ 300 Watts



Controllers must be configured for either 110 or 230 Volts AC input at the factory. One or the other input voltages - not both!

Output power: Variable 0 to 46 Volts DC at < 300 Watts
Output power @ max voltage: 10 amps (max)
Operating Temp: -20 to 100° Fahrenheit (-29 to 38°C)
(Ambient air temperature)
Humidity: Up to 90% humidity
Weight: 16.45 lbs. (7.46kg)
Size: 16"L x 13"W x 7"H
(41cmL x 33cmW x 18cmH)
Input protection: 5A CB

Pump specifications

Electric:
Full Load Rating 2/3 HP
Maximum Amp Draw 10 amps

Overload

Incorporated into Geosub 2 controller

Pipe Connection

Discharge Port:

1/4" female NPT
(includes 3/8" hose barb)

Operating Conditions

Minimum Ambient Fluid Temperature 34°F (1°C)

Maximum Ambient Fluid Temperature 176°F (80°C)

Dimensions & Weight (Pump & Motor)

Dimensions of pump 13.2" L X 1.75" OD (34cmL x 4.5cmOD)

Net Weight of pump w/o lead 4 lbs. (1.8kg)

Weight of small Georeel with the following:

100 feet (30.5m) of 12 AWG & safety cable 18.3 lbs. (8.3kg)

150 feet (46m) of 12 AWG & safety cable 21.6 lbs. (9.8kg)

200 feet (61m) of 12 AWG & safety cable 24.9 lbs. (11.3kg)

Generators

A grounding rod or stake driven directly into moist earth must be installed and electrically connected if using a portable generator larger than 2000 Watts.

EU1000i

A/C Output

120V
1000W max. (8.3A)
900W rated (7.5A)

D/C Output

12V, 96W (8A)

Receptacles

15A 125V Duplex
NEMA Plug: 5-15P

Weight (Lbs.)

29.0 (empty)
33.2 (with fuel and oil)

Dimensions

15.0 x 9.4 x 17.7 – Generator only
20 x 13.75 x 23 – Generator and Legs

EU2000i

A/C Output	120V 2000W max. (16.7A) 16000W rated (13.3A)
D/C Output	12V, 96W (8A)
Receptacles	20A 125V Duplex NEMA Plug: 5-20P
Weight (Lbs.)	46.3 (empty) 53.8 (with fuel and oil)
Dimensions	20.1 x 11.4 x 16.7 – Generator only 21 x 14.75 x 27 - Generator and Legs

Section 7: Replacement Parts List

Controller and Reel Replacement Parts	
Part Description	Part Number
MANUAL, GEOSUB 2 CONTROLLER	21200302
GEOSUB CONTROLLER, CE, 120V, 300W DC OUTPUT	81200034
GEOSUB CONTROLLER, CE, 230V, 300W DC OUTPUT	81200035
GEOSUB CONTROLLER, CE, 120V HARDWIRE, NO PLUG	81200036
GEOSUB CONTROLLER, CE, 230V HARDWIRE, NO PLUG	81200037
CORD, POWER, 6'7"	12070014
CORD, POWER, 230V, 6'	11200850
FUSE, ATC BLADE TYPE, 15A	11201051
CONNECTOR, FEM, 2PIN LARGE GEOSUB CONTROLLER	11201042
CONNECTOR, MALE, 2PIN, LARGE GEOSUB REEL	11201043
ASSY, EXTENSION CORD FOR GEOSUB 15 FT	51201004
CABLE, 12/2AWG, HDPE, SS, GEOSUB 2, W/ SS SAFETY CABLE	21200176
GEOTECH, DC TO AC INVERTER, 600W	81400127
GEOREEL, HAND, GEOSUB 2, 100' CE	81400300
GEOREEL, HAND, GEOSUB 2, 150' CE	81400301
GEOREEL, HAND, GEOSUB 2, 200' CE	81400302

Accessories:

GUIDE, TAPE, DELRIN	22050255
CASE, INVERTER, 11x16x5", W/FOAM	17500220
PUMP, HOLDER, GEOSUB / RF2	52050284
TOOL, ASSEMBLY/DISASSEMBLY, GEOSUB2	51200313
TOOL, PIN, INSERTION, MALE FEMALE, GEOSUB	51200314

Geosub 2 Replacement Parts		
Item	Part Description	Part Number
Standard Pump (see Figure 7-1):		
1	HOSE BARB,SS6,3/8 x 1/4 MPT*	17200357
2a	HANGER,SAFETY CABLE,GEOSUB,SS6	21201015
2b	CABLE,SS,SUSPENSION,3/32"DI	16650300
2c	CRIMP,SS4,3/32",OVAL SLEEVE	17200098
2a-2c	ASSY,HANGER,SAFETY CABLE,GEOSUB	51200315
2d	QUICK LINK,1/8",SS,CABLE LINK	11400001
3	CAP,SS6,TOP,GEOSUB 2	21200076
4a	CAP,SS6,O-RINGS,GEOSUB 2	21200121
4b	SCREW, SS8, 6-32 x 3/8, SHCS	(3x) 12070039
5a	KIT,CONNECTOR,COMP,GEOSUB 2,FEMALE GOLD PINS,FOR LEAD	51200307
5b	KIT,CONNECTOR,COMP,GEOSUB 2, MALE GOLD PINS,FOR MODULE	51200308
6	HOUSING,INNER,SS6,GEOSUB 2	21200072
7	CONTROL MODULE,GEOSUB 2	51200302
8	MOTOR/IMPELLER, GEOSUB 2, 200'	51200300
9	ASSY,MOTOR/CONTROL MODULE,200',GEOSUB 2	51200303
10a	HOUSING,OUTER,GEOSUB 2,SS6	51200298
10b	SCREEN,INTAKE,1.66,SS6	21150095
10c	DISC,SS,1.66	21150148
10d	RING,SNAP,SS6,INTERNAL,1.66	11150051
1-10	PUMP,GEOSUB 2,200',NO LEAD	51200304
Drop Tube Configuration:		
11	HOUSING,DROP TUBE,GEOSUB 2,SS6	51200299
12	TUBING,PE,1/2 x 5/8,FT POLYETHYLENE	87050504
13	INTAKE,1.66SS,DROP TUBE (WITH PTFE TAPE) or INTAKE,1.66SS,DROP TUBE,PFAS FREE	51150071 51150078
1-8,11-13	PUMP,GEOSUB 2,W/ DROP TUBE,200',NO LEAD	51200305
18	HOSE BARB,SS6,1/2 x 3/8"MPT	16600217
19	INTAKE,DROP TUBE,1.66"	21150113
O-Ring Details (see Figure 7-2):		
14	O-RING,BUNA,#29,1/16"	(1x) 11201370
15	O-RING,BUNA-N,1.5mm x 33mm	(4x) 11201372
16	O-RING,BUNA-N,2.4mm x 3.3mm	(2x) 11201371
17	O-RING,BUNA,#016	11201407
14-17	O-RING KIT,GEOSUB 2	51200306
Not shown:		
	CHECK VALVE,GEOSUB 2,1/4"NPT **	81200033

* Hose barbs also available in 1/4" and 1/2" tube O.D.

**Check valve (Part # 81200033) installed in place of item #1

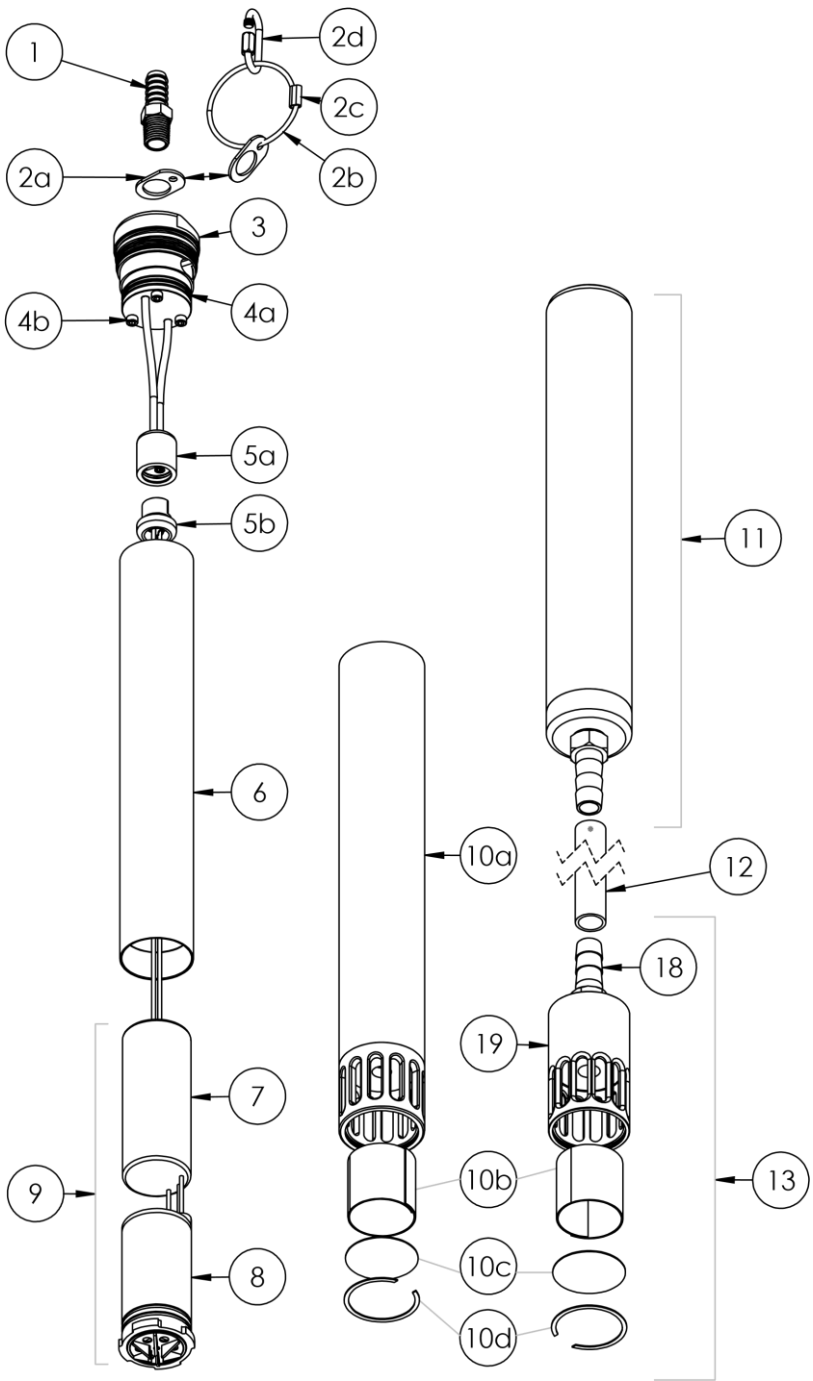

Figure 7-1: Geosub 2 Pump and Drop Tube Assembly

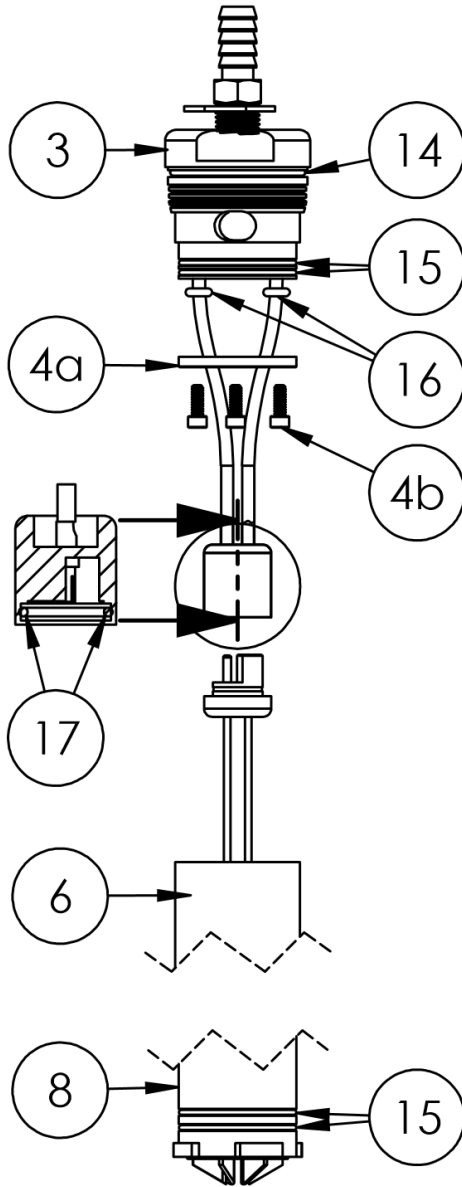

Figure 7-2: Geosub 2 Pump, O-Ring Diagram

To replace the two wire lead o-rings (item #16 in Figure 7-2), remove the three socket head cap screws (item #4b) and dislodge the o-ring plate (item #4a). The connector on the pump end (item #5a in Figure 7-1) must be removed in order to slide the o-rings and plate off the wire leads. Once the o-rings are replaced and the cap reassembled, the connector must be reinstalled as per *Section 4: System Maintenance*.

Notes

DOCUMENT REVISIONS		
PROJECT #	DESCRIPTION	DATE
1690	Release for Geosub 2. SS Geosub information can be found in manual 11200813 - StellaR	11/11/2020
1690	Updated part number list, updated typos - StellaR	11/23/2020
2179	Added new pictures, modified (dis)assembly process, and removed/added relevant PNs for removal of eye bolt and addition of replacement parts and new tools as appropriate. Made all keypad arrow symbols uniform - GR	5/5/2022
2179	Added troubleshooting for "ESC FAULT". Replaced Part 17 with new O-ring. Added hanger plate assy parts to exploded view. Updated Figures 7-1 and 7-2, and female connector steps in System Maintenance for new connector and O-ring. - GR	6/10/2022
2179	Added PN 51200315 to Replacement Parts. Modified "ESC FAULT" solution for in field repair. - GR	6/14/2022
2240	Removed Dry Run feature content. Called out specific wetted materials in System Specifications - GR	7/25/2022
2240	Removed "ESC FAULT" problem from Troubleshooting Section	7/29/2022
2259	Removed well save and recall feature instructions. Added maintenance note to replace connector o-ring with control module. Added PFAS free Drop Tube Intake to Replacement Parts and corrected PN and description of replacement part 19. Updated EC Declaration of Conformity	11/25/2022

EC Declaration of Conformity

Manufacturer:

Geotech Environmental Equipment, Inc.
2650 E 40th Avenue
Denver, CO 80205

Declares that the following products,

Product Name:

Geosub 2 Pump & Controller

Model(s):

Geosub 2 Pump
Geosub 2 Controller 120V
Geosub 2 Controller 230V

Conform to the principle safety objectives of 2006/95/EC Low Voltage Directive by application of the following standards:

61010-1 Ed. 9.0 en:2018
EN 809-1+A1:2010

Year of affixation of the CE Marking: 2023

Conform to the protection requirements of 2004/108/EC Electromagnetic Compatibility (EMC) by application of the following standards:

EN 61000-6-1: 2019
EN 61000-6-3: 2022
EN 61326-1: 2020

EMC conformity established 12/22/2022.

Production control follows the ISO 9001:2015 regulations and includes required safety routine tests.

This declaration issued under the sole responsibility of Geotech Environmental Equipment, Inc.



Joe Leonard
Product Development

Serial number _____

The Warranty

For a period of one (1) year from date of first sale, product is warranted to be free from defects in materials and workmanship. Geotech agrees to repair or replace, at Geotech's option, the portion proving defective, or at our option to refund the purchase price thereof. Geotech will have no warranty obligation if the product is subjected to abnormal operating conditions, accident, abuse, misuse, unauthorized modification, alteration, repair, or replacement of wear parts. User assumes all other risk, if any, including the risk of injury, loss, or damage, direct or consequential, arising out of the use, misuse, or inability to use this product. User agrees to use, maintain and install product in accordance with recommendations and instructions. User is responsible for transportation charges connected to the repair or replacement of product under this warranty.

Equipment Return Policy

A Return Material Authorization number (RMA #) is required prior to return of any equipment to our facilities, please call our 800 number for appropriate location. An RMA # will be issued upon receipt of your request to return equipment, which should include reasons for the return. Your return shipment to us must have this RMA # clearly marked on the outside of the package. Proof of date of purchase is required for processing of all warranty requests.

This policy applies to both equipment sales and repair orders.

FOR A RETURN MATERIAL AUTHORIZATION, PLEASE CALL OUR
SERVICE DEPARTMENT AT 1-800-833-7958.

Model Number: _____

Serial Number: _____

Date of Purchase: _____

Equipment Decontamination

Prior to return, all equipment must be thoroughly cleaned and decontaminated. Please make note on RMA form, the use of equipment, contaminants equipment was exposed to, and decontamination solutions/methods used. Geotech reserves the right to refuse any equipment not properly decontaminated. Geotech may also choose to decontaminate the equipment for a fee, which will be applied to the repair order invoice.



Geotech Environmental Equipment, Inc.

2650 East 40th Avenue Denver, Colorado 80205
(303) 320-4764 • (800) 833-7958 • FAX (303) 322-7242

email: sales@geotechenv.com

website: www.geotechenv.com

In the EU

Geotech Equipos Ambientales

Calle Francesc I Ferrer, Guardia Local 19, Mollet del Valles, Barcelona 08100, España

Tlf: (34)93 5445937

email: ventas@geotechenv.com

website: <http://spanish.geotechenv.com>

Printed in the United States of America