



INSTRUMENTS

GX-3R Pro

Operator's Manual

Part Number: 71-0478

Revision: P1

Released: 5/15/19

WARNING

Read and understand this instruction manual before operating instrument. Improper use of the gas monitor could result in bodily harm or death.

Periodic calibration and maintenance of the gas monitor is essential for proper operation and correct readings. Please calibrate and maintain this instrument regularly! Frequency of calibration depends upon the type of use you have and the sensor types. Typical calibration frequencies for most applications are between 1 and 3 months, but can be required more often or less often based on your usage.

Table of Contents

Chapter 1: Introduction	7
Overview	7
About the GX-3R Pro	7
Specifications	8
About this Manual	11
Chapter 2: Description	12
Overview	12
Instrument Description	12
<i>Case</i>	12
<i>LCD</i>	12
<i>Control Buttons</i>	13
<i>Alarm LEDs</i>	13
<i>Buzzer</i>	13
<i>Vibrator</i>	13
<i>Sensors</i>	13
<i>Filters</i>	14
<i>Infrared Communications Port</i>	15
<i>Charging Socket</i>	15
Included Accessories	16
<i>Alligator Clip</i>	16
<i>Rubber Boot</i>	16
<i>Wrist Strap</i>	16
<i>Single-Unit Charging Cable</i>	16
<i>Calibration Cup</i>	17
Other Accessories	17
<i>Multi-Unit Charger</i>	17
<i>Belt Clip</i>	17
<i>SDM-3R</i>	17
<i>RP-3R</i>	17
<i>IrDA Cable</i>	17
Chapter 3: Measuring Mode	18
Overview	18
Start Up	18
<i>Turning On the GX-3R Pro</i>	18
<i>Performing a Demand Zero</i>	23
<i>Turning Off the GX-3R Pro</i>	23
Measuring Mode Operation	24
<i>Monitoring an Area</i>	24
<i>Combustible Gas Detection</i>	25
Alarms	27
<i>Alarm Indications</i>	27
<i>Responding to Alarms</i>	29
Data Logging	32

Chapter 4: Display Mode	34
Tips for Using Display Mode	35
Peak Screen (PEAK).....	36
STEL Screen (STEL)	36
TWA Screen (TWA)	37
HC GAS LIST.....	37
User ID Screen (USER ID).....	38
Station ID Screen (STATION ID).....	39
Last Successful Calibration Date (CAL DATA).....	40
Last Successful Bump Test Date (BUMP DATA)	41
Date, Time, and Temperature Screen (DATE)	42
Alarm Points Screen (ALARM POINTS)	42
Screen Inversion On/Off (INVERT SELECT).....	43
LCD Color Scheme (LCD BACKGROUND)	44
Turning Bluetooth On/Off (BLUETOOTH).....	44
Adjusting the Buzzer Volume (BUZZER VOLUME)	45
Changing Instrument Language Back to English (LANGUAGE).....	46
Chapter 5: User Mode and Calibration	47
Overview.....	47
Entering User Mode	51
Tips for Using User Mode	52
Performing a Bump Test (BUMP TEST)	53
Performing a Calibration (GAS CAL)	57
Setting Calibration Parameters (CAL SETTING)	68
Setting Bump Test Parameters (BUMP SETTING).....	70
Adjusting Man Down and Panic Settings (MAN DOWN).....	75
Alarm Settings (ALARM SETTING).....	78
Updating the Lunch Break Setting (LUNCH BREAK)	81
Setting the Confirmation Beep and Non-Compliance Indicator (CONFIRMATION).....	82
Auto Backlight in Low Light (AUTO BACKLIGHT).....	84
Updating the Backlight Time (BACKLIGHT TIME).....	84
Turning the Key Tone On/Off (KEY TONE)	85
Display Mode Items (D MODE SETTING).....	85
Reading Units for IR Sensor (IR UNIT SELECT).....	86
CO2 Fresh Air Adjustment On/Off (CO2 AIR SETTING)	87
Setting the Date/Time (DATE)	87
Setting the Date Format (DATE FORMAT).....	88
Changing the Instrument Language (LANGUAGE)	88
Turning the Password On/Off (USER PASSWORD).....	89
Viewing the ROM/SUM (ROM/SUM).....	90
Viewing the Radio Standards (RADIO STANDARD).....	90
Returning to Measuring Mode (START MEASURE)	91

Chapter 6: Maintenance	92
Overview	92
Troubleshooting	92
Replacing the Batteries (Alkaline Version).....	93
Recharging the Batteries	93
Replacing the Buzzer Cover	95
Replacing the Filters.....	95
Replacing the Hydrophobic Dust Filter	97
Replacing a Sensor	98
Chapter 7: General Parts List	100
Appendix A: RK Link Phone App	103
Installing the App	103
Important Setup Notes	103
Pairing a GX-3R Pro.....	103
Searching for a Paired GX-3R Pro	106
Disconnecting a Paired GX-3R Pro	107
Adjusting App Notification Settings.....	108
Defining Owner Information	110
Setting Up Email Alerts	112
Setting the Date/Time in the GX-3R Pro	118
Changing GX-3R Pro Parameters.....	119
<i>Alarm Settings</i>	120
<i>Calibration and Bump Settings</i>	121
<i>Bluetooth Settings</i>	122
<i>Basic Device Settings</i>	123
<i>Logger Data Settings</i>	126
Viewing Serial Number, IDs, and Bump/Cal Information	127
Viewing App Version Info	129
Appendix B: Maintenance Mode	131
Overview	131
Entering Maintenance Mode	133
Tips for Using Maintenance Mode	134
Performing a Calibration (GAS CAL)	134
Performing a Gas Test (GAS TEST).....	134
Sensor/Battery Replacement Date (SENSOR DATE)	136
Performing a Bump Test (BUMP TEST)	137
Setting Alarms to Latching or Self-Resetting (LATCHING).....	138
Turning Demand Zero On/Off (DEMAND ZERO)	138
Turning Auto Zero On/Off (AUTO ZERO)	139
Turning ID Display Function On/Off (ID DISPLAY)	139
Turning Zero Suppression On/Off (ZERO SUPPRESS)	140
Turning Zero Follower On/Off (ZERO FOLLOWER)	140
User Mode Zero Suppression (DISP ZERO SUP)	140
User Mode Zero Follower (DISP ZERO FLWR).....	140
Setting the Date/Time (DATE)	141

Setting the Date Format (DATE FORMAT).....	141
Setting the Instrument Language (LANGUAGE)	142
Turning the Password On/Off (MAINT PASSWORD)	142
Viewing the ROM/SUM (ROM/SUM).....	143
Adjusting the LCD's Contrast (LCD CONTRAST).....	144
Performing a Default (M.DEFAULT).....	145
Exiting Maintenance Mode (START MEASURE).....	145
Appendix C: Gas Select Mode.....	146
Overview.....	146
Entering Gas Select Mode	146
Tips for Using Gas Select Mode.....	147
Changing the Gas Combination (GAS COMBO).....	148
Saving the Alarm Points (SET DEF ALM-P).....	150
Turning the Calibration Max Span On/Off (DISP MAX SPAN)	150
Stealth and Vibrator Settings (STEALTH)	151
LEL Definition (CHANGE LEL).....	152
Exiting Gas Select Mode (START MEASURE).....	153
 WARNING:	
<i>Understand manual before operating. Substitution of components may impair intrinsic safety. To prevent ignition of a hazardous atmosphere, batteries must only be changed or charged in an area known to be nonhazardous. Not tested in oxygen enriched atmospheres (above 21%).</i>	

Chapter 1: Introduction

Overview

This chapter briefly describes the GX-3R Pro gas monitor. This chapter also describes the *GX-3R Pro Operator's Manual* (this document). Table 1 at the end of this chapter lists the specifications for the GX-3R Pro.

About the GX-3R Pro

Using an advanced detection system consisting of up to four gas sensors, the GX-3R Pro personal five-gas monitor detects the presence of combustible gas, oxygen (O₂), carbon monoxide (CO), hydrogen sulfide (H₂S), and CO₂ or a super toxic gas simultaneously. The GX-3R Pro's compact size and easy-to-use design makes it ideally suited for a wide range of applications, including sewage treatment plants, utility manholes, tunnels, hazardous waste sites, power stations, petrochemical refineries, mines, paper mills, drilling rigs, and fire fighting stations. The GX-3R Pro offers a full range of features, including:

- Simultaneous monitoring of one to five gases
- Liquid crystal display (LCD) for complete and understandable information at a glance
- Ultrabright alarm LEDs
- Distinctive audible/vibrating alarms for dangerous gas conditions and audible alarms for unit malfunction
- Microprocessor control for reliability, ease of use, and advanced capabilities
- Data logging functions
- Alarm trend data
- STEL, TWA, and over range alarms
- Peak readings
- Built-in time function
- Lunch break feature
- CSA "C/US" classification for Class I, Division I, Groups A, B, C, and D hazardous atmospheres (pending)

WARNING: *The Model GX-3R Pro detects oxygen deficiency, elevated levels of oxygen, combustible gases, carbon monoxide, and hydrogen sulfide, all of which can be dangerous or life threatening. When using the GX-3R Pro, you must follow the instructions and warnings in this manual to assure proper and safe operation of the unit and to minimize the risk of personal injury. Be sure to maintain and periodically calibrate the GX-3R Pro as described in this manual.*

Specifications

Table 1: Standard Sensor Specifications

	Combustible Gas, Methane (CH₄) Calibration Standard*	Oxygen (O₂)	Hydrogen Sulfide (H₂S)	Carbon Monoxide (CO)
Detection Range	0 - 100% LEL	0 - 25% volume	0 - 100.0 ppm	0 - 500 ppm
Service Range	n/a	25.1 - 40% volume	100.1 - 200.0 ppm	501 - 2,000 ppm
Reading Increment	1% LEL	0.1% volume	0.1 ppm	1 ppm
Warning Factory Setting	10% LEL**	19.5% volume, decreasing**	5.0 ppm**	25 ppm**
Alarm Factory Setting	25% LEL	18.0% volume, decreasing	30.0 ppm	50 ppm
Alarm H Factory Setting	50% LEL	23.5% volume, increasing	100.0 ppm	1200 ppm
STEL Alarm	n/a	n/a	5.0 ppm	200 ppm
TWA Alarm	n/a	n/a	1.0 ppm	25 ppm

* The GX-3R Pro is also available set up for general hydrocarbons and calibrated to a combustible gas other than methane, such as isobutane. Consult RKI Instruments, Inc. for further information.

Table 2: IR Sensor Specifications

	Carbon Dioxide (CO₂)	
Detection Range	0 - 5.00% volume	0 - 10,000 ppm
Service Range	5.01 - 10.00% volume	n/a
Reading Increment	0.01% volume	20 ppm
Warning Factory Setting	0.50% volume*	5,000 ppm*
Alarm Factory Setting	3.00% volume	5,000 ppm
Alarm H Factory Setting	3.00% volume	5,000 ppm
STEL Alarm	3.00% volume	n/a
TWA Alarm	0.50% volume	5,000 ppm

Table 3: EC Sensor Specifications

	Sulfur Dioxide (SO₂)
Detection Range and Service Range	0 - 100.00 ppm (parts per million)
Reading Increment	0.05 ppm
Warning Factory Setting	2.00 ppm*
Alarm Factory Setting	5.00 ppm
Alarm H Factory Setting	100.00 ppm
STEL Alarm	5.00 ppm
TWA Alarm	2.00 ppm

Table 4: GX-3R Pro Specifications

Sampling Method	Diffusion
Response Time	T90 within 30 seconds
Display	Graphics LCD Display
Operating Temperature & Humidity	Continuous environment: -20°C to 50°C/Below 90% RH Temporary environment (up to 15 minutes): -40°C to 60°C/Below 95% RH
Indication Accuracy for Detection Range	Combustible Gas, Catalytic Type Sensor • ± 5% of reading or ± 2% LEL (whichever is greater) Oxygen • ± 0.5% O ₂ Hydrogen Sulfide • ± 5% of reading or ± 2 ppm H ₂ S (whichever is greater) Carbon Monoxide • ± 5% of reading or ± 5 ppm CO (whichever is greater) Carbon Dioxide (IR) • ± 5% of reading or ± 2% of full scale (whichever is greater) Sulfur Dioxide (EC) • ± 10% of reading or ± 5% of full scale (whichever is greater)
Indication Accuracy for Service Range	Oxygen • ± 3.0% O ₂ Hydrogen Sulfide, Carbon Monoxide, and Carbon Dioxide • ± 20% of reading

<p>Safety/ Regulatory</p>	<ul style="list-style-type: none"> • ATEX: II 1 G Ex da ia IIC T4 Ga Certificate Number: DEKRA 17ATEX0103 X • IECEx: Ex da ia IIC T4 Ga Certificate Number: IECEx DEK 17.0050X • CSA classified, “C/US”, as Intrinsically Safe. Exia. Class I, Groups A, B, C, & D. Temperature Code T3A. (pending) <div style="text-align: center;">  C US 186718 </div>
<p>Power Supply</p>	<ul style="list-style-type: none"> • Lithium ion battery pack OR <ul style="list-style-type: none"> • Alkaline battery pack
<p>Continuous Operating Hours @ 25 °C</p>	<p><u>Lithium Ion Battery Pack</u></p> <ul style="list-style-type: none"> • 25 hours in Normal Mode for standard 4 gas plus EC sensor (non-alarm operation) • 16 hours in Normal Mode for standard 4 gas plus IR sensor (non-alarm operation) <p><u>Alkaline Battery Pack</u></p> <ul style="list-style-type: none"> • 16 hours in Normal Mode for standard 4 gas plus EC sensor (non-alarm operation) • 7 hours in Normal Mode for standard 4 gas plus IR sensor (non-alarm operation)
<p>Case</p>	<p>High-impact Plastic, RF Shielded, Dust and Weather Proof (IP68)</p>
<p>Included Accessories</p>	<ul style="list-style-type: none"> • Alligator clip • Rubber boot • Wrist strap • Calibration cup • Single-unit charger cable (included with Li-ion versions only)
<p>Other Accessories</p>	<ul style="list-style-type: none"> • Multi-unit charger cable • Belt clip • SDM-3R • RP-3R • IrDA/USB Cable for connecting to a computer when using the Data Logger Management Program (not needed if computer has an infrared port)
<p>Dimensions and Weight</p>	<p><u>Lithium Ion Battery Pack Version</u> Approximately 65(H) x 73(W) x 26(D) mm (2.6”H x 2.9”W x 1.0”D) Approximately 120 g (4.2 oz.)</p> <p><u>Alkaline Battery Pack Version</u> Approximately 65(H) x 73(W) x 34(D) mm (2.6”H x 2.9”W x 1.3”D) Approximately 140 g (4.9 oz.)</p>

About this Manual

The *GX-3R Pro Operator's Manual* uses the following conventions for notes, cautions, and warnings.

NOTE: Describes additional or critical information.

CAUTION: *Describes potential damage to equipment.*

WARNING: *Describes potential danger that can result in injury or death.*

Chapter 2: Description

Overview

This chapter describes the GX-3R Pro instrument and its accessories.

Instrument Description

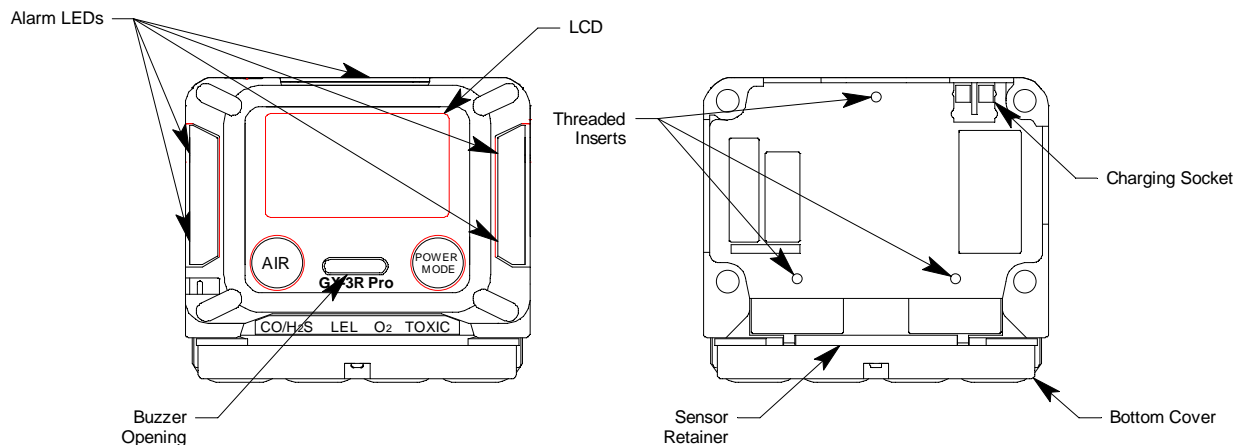

Figure 1: Component Location

Case

The GX-3R Pro's sturdy, high-impact plastic case is radio frequency (RF) resistant and is suitable for use in many environmental conditions, indoors and out. The case is dust proof and water resistant. A clear plastic window is located on the front of the case for viewing the LCD. The black bottom cover is located on the bottom of the case and allows access to the filters and sensors. A sensor retainer and filter gasket help orient and retain the sensor and filters.

Three threaded inserts on the back of the case allow for installation of an alligator clip or belt clip.

LCD

A digital LCD (liquid crystal display) is visible through a clear plastic window in the top case. The LCD simultaneously shows the gas reading for all installed sensors. The LCD also shows information for each of the GX-3R Pro's operating modes.

Control Buttons

Two control buttons, AIR and POWER MODE are located below the LCD.

Table 5: GX-3R Pro Control Button Functions

Button	Function(s)
AIR	<ul style="list-style-type: none">• turns on LCD backlight• resets alarm condition if LATCHING is set to ON in Maintenance Mode• enters User Mode, Maintenance Mode, and Gas Select Mode when used with POWER MODE button• activates the demand zero function (adjusts the GX-3R Pro's fresh air reading)• changes the value of a parameter available for adjustment• scrolls through parameter options
POWER MODE	<ul style="list-style-type: none">• turns the GX-3R Pro on and off• turns on LCD backlight• enters and scrolls through Display Mode• enters instructions into the GX-3R Pro's microprocessor• resets alarm condition if LATCHING is set to ON in Maintenance Mode• enters User Mode, Maintenance Mode, and Gas Select Mode when used with AIR button

Alarm LEDs

Five sets of red alarm LEDs (light emitting diodes) around the edge of the case alert you to gas, low battery, and failure alarms.

Buzzer

One solid-state electronic buzzer is located inside the case. A hole in the middle front of the case allow the sound to exit the case. The buzzer sounds for gas alarms, malfunctions, low battery voltage, and as an indicator during use of the GX-3R Pro's many display and adjustment options.

Vibrator

A vibrating motor inside the GX-3R Pro case vibrates for gas alarms, unit malfunctions, and as an indicator during normal use of the various modes of the GX-3R Pro.

NOTE: If **STEALTH** is set to **ON**, the vibrator only functions when **VIBRATION** in the **STEALTH** Gas Select Mode item is set to **ON**. See "Stealth and Vibrator Settings (STEALTH)" on page 151.

Sensors

The GX-3R Pro uses four sensors to monitor up to 5 gases simultaneously. The sensors are located inside the GX-3R Pro and are held in their sockets by the sensor retainer and bottom cover. The sensors use different detection principles, as described below.

Combustible Gas Sensor

The combustible gas sensor detects combustible gas in the % LEL range. It uses a catalytic element for detection. The reaction of gas with oxygen on the catalyst causes a change in the resistance of the element which affects the current flowing through it. The current is

amplified by the GX-3R Pro's circuitry, converted to a measurement of combustible gas concentration, and displayed on the LCD.

The standard calibration for the combustible gas sensor is to methane but the sensor will still detect and respond to a variety of combustible gases.

O₂/CO/H₂S/Super Toxic Sensors

The O₂, CO, H₂S, and super toxic sensors are electrochemical cells that consist of two precious metal electrodes in a dilute acid electrolyte. A gas permeable membrane covers the sensor face and allows gas to diffuse into the electrolyte. The gas reacts in the sensor and produces a current proportional to the concentration of the target gas. The current is amplified by the GX-3R Pro's circuitry, converted to a measurement of gas concentration, and displayed on the LCD.

There are 4 different types of CO and H₂S sensors available:

- CO only (ESR-A13P): A single electrochemical cell that detects CO. Instruments with this sensor cannot detect H₂S.
- H₂ compensated CO (ESR-A1CP): A single electrochemical cell that detects CO. This sensor does not respond to or responds minimally to hydrogen. Instruments with this sensor cannot detect H₂S.
- H₂S only (ESR-A13i): A single electrochemical cell that detects H₂S. Instruments with this sensor cannot detect CO.
- CO/H₂S (ESR-A1DR): A combination electrochemical cell that detects both CO and H₂S.

IR Sensors

The infrared sensors detect CO₂ in the ppm and %volume ranges. Gas enters the sensor through an opening on its face. Infrared light shines through the gas and into an infrared detector. The intensity of the infrared light changes with the gas concentration and this change is converted to an electrical signal. The instrument's circuitry converts the signal into a gas concentration.

Dummy Sensors

Any unit that has less than 4 sensors will have a dummy sensor installed in one or more unused sensor positions. Dummy sensors are factory installed. The flat side of the dummy sensor should face away from the GX-3R Pro and the hollow side should face toward the GX-3R Pro.

Filters

Combustible Gas Sensor H₂S Removal Filter Disk (Dark Red)

An H₂S removal filter disk is placed into a recess in the filter gasket over the combustible gas sensor. It prevents H₂S in the ambient air from reaching the combustible gas sensor which prolongs the life of the sensor. The H₂S filter disk is dark red in color and although it may darken over time, its color is not indicative of remaining filter life.

The H₂S filter disk can absorb H₂S for 33 ppm hours and should be replaced after that much exposure. With this many ppm hours of absorption, the H₂S filter disk should be replaced after 80 minutes of exposure to 25 ppm H₂S. This equates to replacing the H₂S filter disk after 40 2-minute calibrations with a cylinder containing 25 ppm H₂S. If H₂S exists in the monitoring environment, the H₂S filter disk will have to be replaced more

frequently.

Charcoal Filter (Black)

A black charcoal filter is placed into a recess in the filter gasket over the CO sensor. The charcoal filter disk scrubs H₂S and certain hydrocarbons out of the sample to avoid false CO readings. If false or elevated CO readings are noticed, especially in the presence of H₂S, change the charcoal filter.

If your instrument has a combo CO/H₂S sensor, it will have a filter installed that is half black charcoal filter and half white humidity filter.

Humidity Filter (White)

A white humidity filter covers the H₂S sensor.

If your instrument has a combo CO/H₂S sensor, it will have a filter installed that is half black charcoal filter and half white humidity filter.

SO₂ Sensor H₂S Removal Filter Disk (Tan)

An H₂S removal filter disk is placed into a recess in the filter gasket over the SO₂ sensor (if an SO₂ sensor is installed). It prevents H₂S in the ambient air from reaching the SO₂ sensor which prolongs the life of the sensor.

Hydrophobic Dust Filter

The hydrophobic dust filter sits on the filter gasket, covering the sensor ports and the filters.

Infrared Communications Port

An infrared (IR) communications port is located on the top of the case, near the top LEDs. The data transmitted through the port is in standard IrDA protocol. A computer's infrared port or an IrDA/USB cable connected to a USB port can be used to download data saved by the GX-3R Pro to a computer using the GX-3R Pro Data Logger Management Program. See the GX-3R Pro Data Logger Management Program operator's manual for data logging and downloading instructions.

Battery Pack

The GX-3R Pro is either powered by a rechargeable lithium-ion (Li-ion) battery pack or an alkaline battery pack. Instruments with a Li-ion battery pack have a charging socket on the back of the instrument. Instruments with an alkaline battery pack have a cover that allows for battery replacement.

The battery icon in the upper right of the LCD shows remaining battery life. When the GX-3R Pro detects a low battery voltage, a low battery warning is activated. When battery voltage is too low for Measuring Mode, the GX-3R Pro sounds a dead battery alarm.

NOTE: Use of batteries or battery chargers not specified by RKI Instruments, Inc. will compromise the CSA classification and may void the warranty. See pg.93 and pg.94 for more information.

WARNING: *To prevent ignition of a hazardous atmosphere, batteries must only be changed or charged in an area known to be nonhazardous.*

AVERTISSEMENT: Pour éviter l'inflammation d'une atmosphère dangereuse, les batteries doivent uniquement être modifiées ou facturés dans une zone connue comme non dangereuse.

Included Accessories

Alligator Clip

An alligator clip is installed on the back of the GX-3R Pro. The alligator clip can be used to attach the GX-3R Pro to clothing or a belt. Teeth in the alligator clip's jaws prevent the unit from slipping off. The alligator clip can be rotated to change how the instrument is oriented when worn.

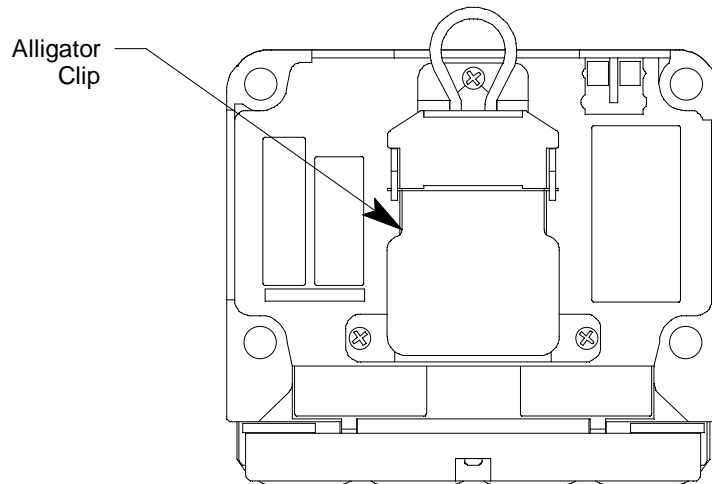

Figure 2: Alligator Clip

Rubber Boot

A black rubber boot is installed on the GX-3R Pro.

Wrist Strap

A wrist strap is included with the GX-3R Pro and can be attached to the wrist strap installation feature on the left side of the GX-3R Pro's case.

Single-Unit Charging Cable

The charging cable has an AC adapter on one end and a charging plug that connects to the GX-3R Pro on the other end.

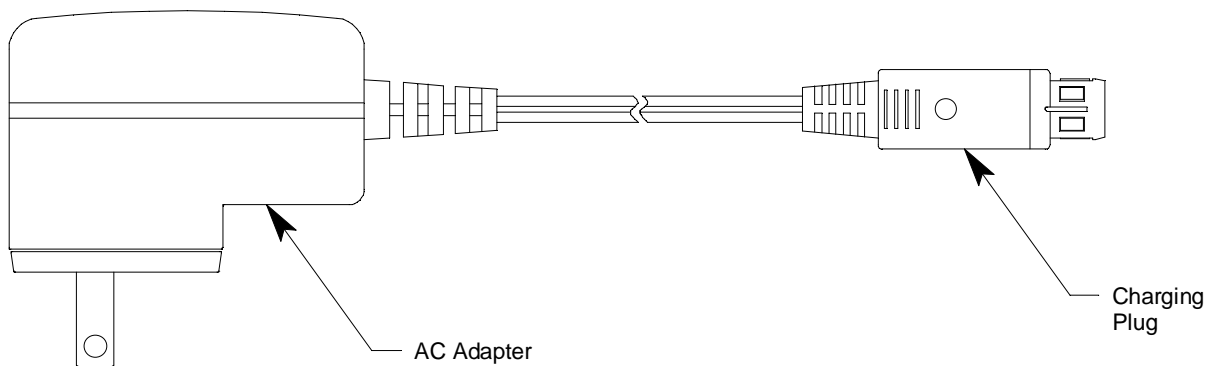

Figure 3: Charging Cable

Calibration Cup

Use the calibration cup to apply gas during a bump test, calibration, or gas test. The calibration cup has an installation orientation to observe. “Front” and “rear” imprinting on the bottom of the cup correspond to the front and rear of the GX-3R Pro when the calibration cup is installed. In addition, a “front” label on the front of the calibration cup should be visible when viewing the LCD with the calibration cup installed.

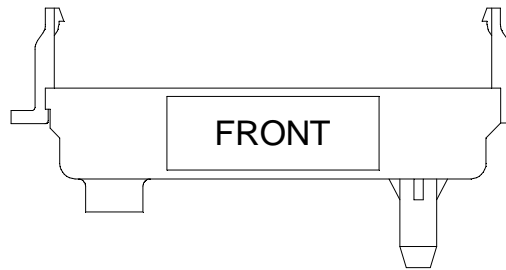

Figure 4: Calibration Cup

Other Accessories

Multi-Unit Charger

The multi-unit charger is a wall plug style adapter that plugs into a bar. The bar has five 4-foot cables coming out one side. The end of each of the five cables has a plug that connects to the GX-3R Pro's power jack. The AC adapter is rated 100 - 240 VAC input, 5.99 VDC output.

Belt Clip

A belt clip makes it easy to hook the GX-3R Pro to a utility belt.

SDM-3R

The SDM-3R is a calibration station for the GX-3R and GX-3R Pro. The station's buttons can be used for operations (Standalone Mode) or a computer can be used to control the docking station (PC Controlled Mode). See the appropriate SDM-3R manual for more information.

RP-3R

The RP-3R is a pump that allows sample to be drawn to the GX-3R Pro.

IrDA Cable

Unless your computer has a built-in IrDA port, an IrDA cable is needed to establish communication between the GX-3R Pro and the Datalogging Program or the User Setup Program.

Chapter 3: Operation

Overview

This chapter explains how to use the GX-3R Pro to perform confined space entry monitoring or general area monitoring in Measuring Mode. Display Mode is accessed by pressing POWER MODE from Measuring Mode and is described on pg.34.

Start Up

This section explains how to start up the GX-3R Pro, get it ready for operation, and turn it off.

NOTE: The screens illustrated in this section are for a 4-gas + 0 - 10.00% volume CO₂ unit. The screens displayed by your GX-3R Pro may be slightly different.

Turning On the GX-3R Pro

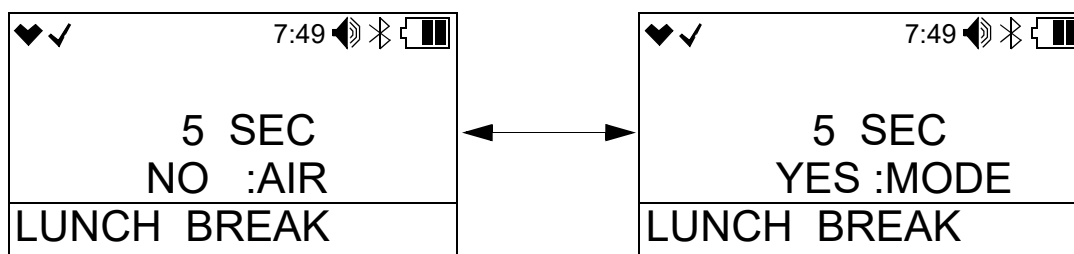

To illustrate certain functions, the following description of the GX-3R Pro start up sequence assumes that the following menu items are turned on: **LUNCH BREAK**, **CAL REMINDER**, and **BUMP REMINDER** in User Mode, and **ID DISPLAY** and **AUTO ZERO** in Maintenance Mode. If any of these items are turned off, then the corresponding screens will not appear.

1. Press and briefly hold down POWER MODE. Release the button when you hear a beep.
2. If **LUNCH BREAK** is set to **ON** (factory setting is **OFF**, see pg.81), the Lunch Break Screen appears. The unit counts down from 5 seconds.



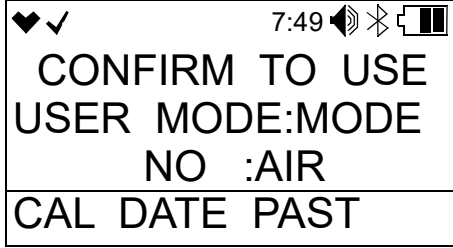

- a. Continue Accumulating: To continue accumulating peak and time-weighted average (TWA) readings from the last time the GX-3R Pro was used, press and release POWER MODE or allow the countdown to reach 0. The short-term exposure limit (STEL) reading is reset each time the GX-3R Pro is turned on.
- b. Reset Accumulation: To reset the accumulation of peak and time-weighted average (TWA) readings, press and release AIR before the countdown reaches 0.

3. If **CAL REMINDER** is set to **ON** (factory setting) and a calibration is due, the screen that appears next depends on how **CAL EXPIRED** is set in User Mode (see pg.69). The three possible screens are described below. If a calibration is not due, the instrument will tell you how many days are left until a calibration is due.

	CAL EXPIRED set to CONFIRM TO USE (factory setting)	CAL EXPIRED set to CANNOT USE	CAL EXPIRED set to NO EFFECT
LCD			
Sound	Buzzer sounds double pulsing tone	Buzzer sounds double pulsing tone	None
Action	<ul style="list-style-type: none"> • Option A, Perform calibration: Press and release POWER MODE to enter User Mode to perform a calibration. See pg.57 for calibration instructions. If the calibration was successful, the screen above will not appear again until the unit is due for calibration. If the calibration was not successful, the screen above will again appear in the startup sequence. • Option B, Bypass message: To continue without performing a calibration, press and release AIR. 	<p>The GX-3R Pro cannot be used until a successful calibration has been performed. Press and release POWER MODE to enter User Mode and perform a calibration. See pg.57 for calibration instructions.</p> <p>If the calibration was successful, the screen above will not appear again until the unit is due for calibration. If the calibration was not successful, the screen above will again appear in the startup sequence.</p>	<ul style="list-style-type: none"> • Option A, Perform calibration: If you want to enter User Mode to perform a calibration, press and release POWER MODE. • Option B, Bypass message: To continue without performing a calibration, wait a few seconds for the instrument to continue with its startup sequence.

4. If **BUMP REMINDER** is set to **ON** (factory setting is **OFF**) and a bump test is due, the screen that appears next depends on how **BUMP EXPIRED** is set in User Mode (see pg.74). The three possible screens are described below. If a bump test is not due, the instrument will tell you how many days are left until a bump test is due.

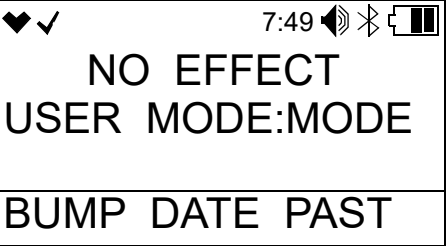
	BUMP EXPIRED set to CONFIRM TO USE (factory setting)	BUMP EXPIRED set to CANNOT USE	BUMP EXPIRED set to NO EFFECT
LCD			
Sound	Buzzer sounds double pulsing tone	Buzzer sounds double pulsing tone	None
Action	<ul style="list-style-type: none"> • <u>Option A, Perform bump test</u>: Press and release POWER MODE to enter User Mode to perform a bump test. See pg.53 for bump test instructions. If the bump test was successful, the screen above will not appear again until the unit is due for bump testing. If the bump test was not successful, the screen above will again appear in the startup sequence. • <u>Option B, Bypass message</u>: To continue without performing a bump test, press and release AIR. 	<p>The GX-3R Pro cannot be used until a successful bump test has been performed. Press and release POWER MODE to enter User Mode and perform a bump test. See pg.53 for bump test instructions.</p> <p>If the bump test was successful, the screen above will not appear again until the unit is due for bump testing. If the bump test was not successful, the screen above will again appear in the startup sequence.</p>	<ul style="list-style-type: none"> • <u>Option A, Perform bump test</u>: If you want to enter User Mode to perform a bump test, press and release POWER MODE. • <u>Option B, Bypass message</u>: To continue without performing a bump test, wait a few seconds for the instrument to continue with its startup sequence.

5. The Date/Time Screen appears for a few seconds.

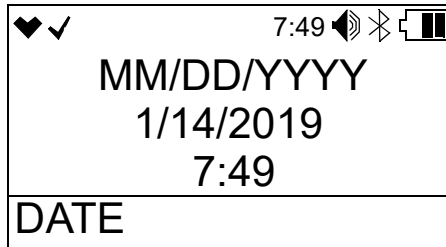

6. The Battery Voltage Screen appears for a few seconds. The battery voltage is shown on the top line. The alarm latching/self-resetting setting is shown on the second line (see pg.138 for a description of how to change this setting). The battery pack type is shown on the bottom line.



7. The following screens display for 3 seconds each: the Gas Name Screen, the Full Scale Screen, the Warning Setpoint Screen, the Alarm Setpoint Screen, the Alarm H Setpoint Screen, the STEL Alarm Screen, and the TWA Alarm Screen.

NOTE: If the combustible gas is set to something other than CH4 or H2 in Gas Select Mode, the combustible channel is displayed as “HC” and the gas formula for the combustible gas sensor’s target gas appears during startup.

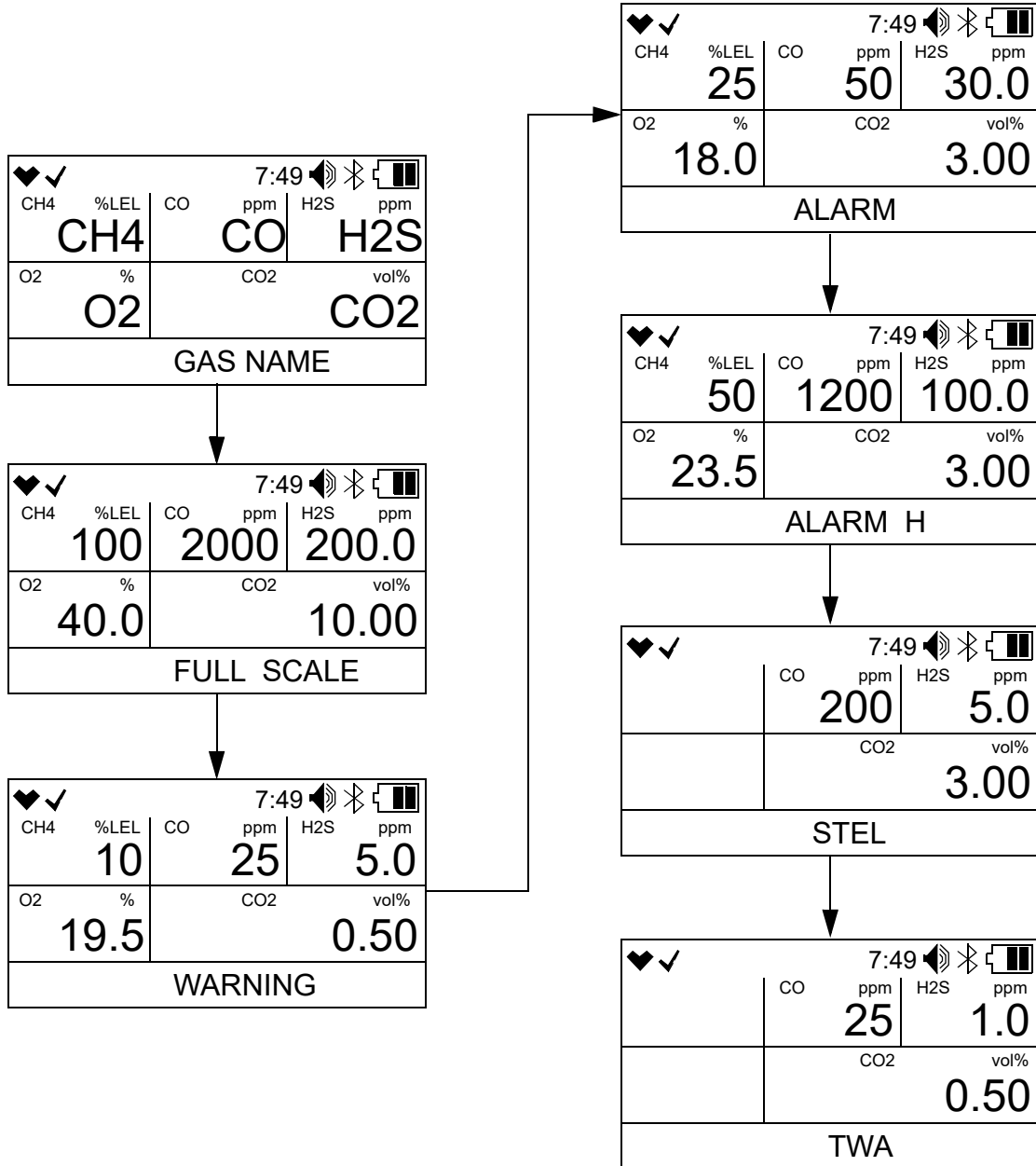

- 8 . If **ID DISPLAY** is set to **ON** (factory setting is **OFF**, see pg.139), the User ID Screen appears for a few seconds, followed by the Station ID Screen.

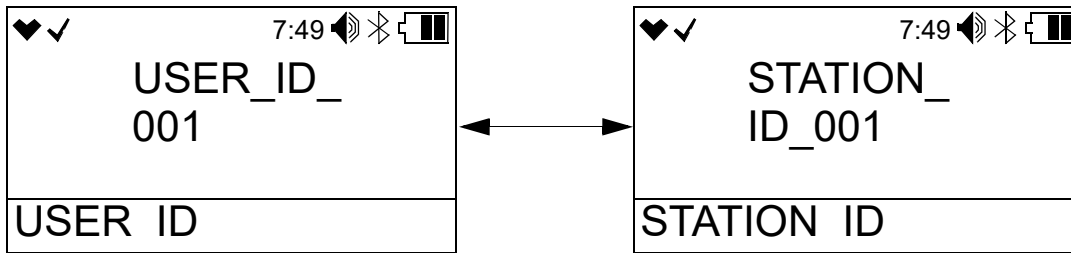

- 9 . If the GX-3R Pro experiences a sensor failure during start up, a screen indicating which sensor failed appears and the buzzer sounds a double pulsing tone once per second. In the example below, the combustible gas sensor has failed.

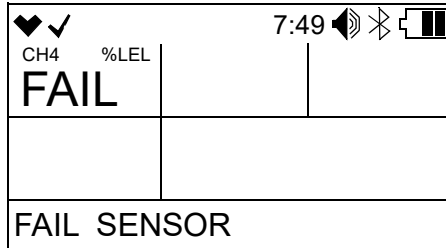

Press and release **POWER MODE** to acknowledge the failure and continue. The gas reading for the failed sensor will be replaced by “- - - -”. Replace the failed sensor as soon as possible.

- 10 . If **AUTOZERO** is set to **ON** (factory setting is **OFF**, see pg.139), the instrument prompts you to do an auto zero. An auto zero operation sets the combustible gas, H₂S, CO, and super toxic channels to zero and the OXY channel to 20.9%.

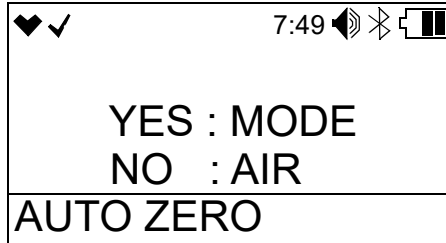

WARNING: *Make sure that the instrument is in a known fresh air environment (an environment free of combustible or toxic gases and of normal oxygen content, 20.9%) before performing an auto zero operation. If you perform an auto zero operation in an area with gases present, the adjustment will not be accurate.*

- An auto zero operation sets the combustible gas, H₂S, CO, and super toxic channels to 0 and the OXY channel to 20.9%.
- If the instrument has a CO₂ sensor installed and if **CO2AIR SETTING** is set to **ON** in User Mode, the CO₂ channel gets set to 400 ppm (0.04% volume) during an auto zero. If **CO2AIR SETTING** is set to **OFF** in User Mode, the CO₂ channel is not adjusted during the auto zero.
- You must press and release the **POWER MODE** button to perform an auto zero function. If you do not press any key, after 15 seconds, the instrument will enter Measuring Mode without performing an auto zero.

- 11 . The GX-3R Pro is now monitoring for gas in Measuring Mode. The Measuring Mode Screen appears displaying the current gas reading for each target gas.

♥ ✓		7:49		🔊 🔇 🔋	
CH4	%LEL	CO	ppm	H2S	ppm
	0		0		0.0
O2	%	CO2	vol%		
	20.9		0.00		

Performing a Demand Zero

Before using the GX-3R Pro, it is recommended to set the fresh air readings for the target gases by performing a demand zero. This will set the combustible gas, H₂S, CO, and super toxic channels to zero and the OXY channel to 20.9%.

If the instrument has a CO₂ sensor installed and if **CO2AIR SETTING** is set to **ON** in User Mode, the CO₂ channel gets set to 400 ppm (0.04% volume). If **CO2AIR SETTING** is set to **OFF** in User Mode, the CO₂ channel is not adjusted during the demand zero.

- 1 . Find a fresh-air environment. This is an environment free of toxic or combustible gases and of normal oxygen content (20.9%).
- 2 . Turn on the unit as described above in “Turning On the GX-3R Pro”.
- 3 . Press and hold AIR. The LCD prompts you to continue holding AIR and the buzzer will pulse while you hold the button (if **KEY TONE** is set to **ON** in User Mode).
- 4 . Continue to hold AIR until the LCD prompts you to release it. The GX-3R Pro will set the fresh air reading for all channels. Start up is complete and the unit is now ready for monitoring.

Turning Off the GX-3R Pro

- 1 . Press and hold POWER MODE.
- 2 . TURN OFF will appear on the display and the buzzer will pulse for about five seconds (if **KEY TONE** is set to **ON** in User Mode).
- 3 . Release the button when TURN OFF disappears from the display.

Measuring Mode Operation

When the GX-3R Pro completes its startup sequence, it is in Measuring Mode. In Measuring Mode the GX-3R Pro continuously monitors the sampled atmosphere and displays the gas concentrations present for its target gases. The GX-3R Pro is considered to be in Normal Operation if there are no alarm indications.

If **BUMP REMINDER** is set to **ON** and if a bump test is not due, a check mark will appear in the upper left corner of the LCD.

If the instrument is operating in Stealth Mode, an “S” will appear at the top of the LCD.

♥✓		S	7:49		
CH4	%LEL	CO	ppm	H2S	ppm
	0		0		0.0
O2	%	CO2			vol%
	20.9				0.00

In a low-light environment, press and release either button to turn on the display backlight. See pg.84 to set the backlight time.

If the **BEEP** menu item in User Mode is set to anything other than **OFF**, the GX-3R Pro will give periodic indications to confirm that it's operating or to indicate a non-compliance (see pg.82 for instructions).

Monitoring an Area

1. Start up the GX-3R Pro as described above in “Start Up” on page 18. It is now in Measuring Mode.

♥✓			7:49	🔊	📶	🔋
CH4	%LEL	CO	ppm	H2S	ppm	
	0		0		0.0	
O2	%	CO2			vol%	
	20.9				0.00	

2. Take the GX-3R Pro to the monitoring area.
3. Wait at least 15 seconds and observe the display for gas readings. If a reading is observed, allow the reading to stabilize to determine the gas concentrations present.
4. If a gas alarm occurs, take appropriate action. See pg.29.

Combustible Gas Detection

There are three issues to keep in mind when monitoring for combustible gas.

- The combustible gas sensor will respond to any combustible gas. The standard calibration gas for the combustible gas channel is methane (CH₄). If the instrument is setup for and calibrated to a different combustible gas, such as hexane or propane, the gas name right above the readings displays as “HC”.

The table below lists the conversion factors for several hydrocarbon gases **if the GX-3R Pro is calibrated to methane**. To use this table, multiply the display reading on the combustible gas channel by the factor in the appropriate row to obtain the actual gas concentration. For example, if you are detecting ethylene and the display reads 10% LEL for the combustible gas channel, you actually have 10% LEL x 1.20 = 12.0% LEL ethylene present.

Table 6: LEL Hydrocarbon Conversions

Gas	LEL Conversion Factor (from CH ₄ Cal.)
Acetone	0.45
Acetylene	0.70
Benzene	0.40
Butadiene	0.66
Cyclopentane	0.69
DME	0.86
Ethane	1.06
Ethanol	0.51
Ethyl Acetate	0.35
Ethylene	1.20
Heptane	0.32
Hexane	0.53
Hydrogen	1.05

Gas	LEL Conversion Factor (from CH ₄ Cal.)
IPA	0.61
Isobutane	0.91
MEK	0.38
Methane-	1.00
Methanol	0.55
MIBK	0.25
MMA	0.30
Nonane	0.11
Propane	0.89
Propylene	1.03
THF	0.43
Toluene	0.22
Xylene	0.13

- The GX-3R Pro provides the combustible gas sensor with some protection against exposure to high levels of combustible gas which can damage the sensor. It does this by turning off the combustible gas sensor power temporarily when it determines that an over scale (more than 100 %LEL) concentration of combustible gas is present that may damage the sensor. Nevertheless, concentrations of combustible gas of more than 100 %LEL can still affect the zero level or calibration of the combustible gas sensor if the concentration is high enough.

CAUTION: *Do not expose the combustible gas sensor to high concentrations of combustible gas such as that from a butane lighter. Exposure to high concentrations of combustible gas may adversely affect the performance of the sensor.*

CAUTION: Any rapid increase in the combustible gas reading on the combustible gas channel followed by a declining or erratic reading may indicate a gas concentration above the LEL which may be hazardous.

- Some gases such as silicone vapors, chlorinated hydrocarbons, and sulphur compounds can contaminate the detection elements inside the combustible gas sensor damaging the sensor and result in reduced response to combustible gas. Make every effort to avoid these gases.

The H₂S scrubber disks protect the combustible sensor from H₂S, but you should avoid other sulphur compounds.

CO₂ Detection

- A background level of CO₂ exists in fresh air. Table 7 below indicates a typical gas reading in fresh air.

Table 7: Carbon Dioxide Fresh Air Readings

Sensor Range	Approximate Fresh Air Reading
0 - 10.00% volume	0.04% volume
0 - 10,000 ppm	400 ppm

- Performing a demand zero, an auto zero, or an **AIR CAL** will either set to CO₂ channel to 400 ppm (0.04% volume) or exclude the CO₂ channel based on the setting of the **CO2AIR SETTING** User Mode parameter. See pg.87 for more information.

Toxic Gas Detection

Positive Interference

The table below indicates some of the gases that will cause an increased gas reading for the affected sensor. For example, if you are attempting to detect SO₂ but H₂ is also present, the instrument's SO₂ reading will be higher than the environment's actual SO₂ level.

Table 8: Positive Interference

Sensor	Affected By:
SO ₂	H ₂

Negative Interference

The table below indicates some of the gases that will cause a negative response and a decreased reading for the affected sensor. For example, if you are attempting to detect SO₂ but NO₂ is also present, the instrument's SO₂ reading will be lower than the environment's actual SO₂ level.

Table 9: Negative Interference

Sensor	Affected By:
SO ₂	NO ₂

Alarms

This section covers alarm indications in Measuring Mode. It also describes how to reset the GX-3R Pro after an alarm occurs and how to respond to an alarm condition.

NOTE: False alarms may be caused by radio frequency (RF) or electromagnetic (EMI) interference. Keep the GX-3R Pro away from RF and EMI sources such as radio transmitters or large motors.

Alarm Indications

The GX-3R Pro buzzer will sound an alarm, the LEDs will flash, and the vibrator will pulse when any sort of alarm condition or failure is encountered. If the GX-3R Pro is operating in Stealth Mode, the buzzer will not sound and the vibrator's operation will depend on the **VIBRATION** setting in Gas Select Mode's **STEALTH** menu item. See pg.151 for more information.

NOTE: If an alarm condition occurs while you are in Display Mode, the GX-3R Pro will automatically bring up the alarm screen instead.

The table below summarizes the types of alarms produced by the GX-3R Pro and their indications.

None of the Man Down alarm indications will happen if **MAN DOWN** is set to **OFF** (factory setting) in User Mode. The Panic alarm will not happen if **PANIC** is set to **OFF** (factory setting) in User Mode.

Table 10: Alarm Types and Indications

Alarm Type	Visual Indications	Other Indications
Warning Concentration of gas rises above the Warning setting or falls below the Warning setting for O ₂ .	<ul style="list-style-type: none">Affected channel's gas reading flashes and the units field alternates between the units and AL1Alarm LEDs flash in circle sequence once per secondBacklight turns on	<ul style="list-style-type: none">High-low tone sounding once per secondVibrator pulses once per second

Table 10: Alarm Types and Indications

Alarm Type	Visual Indications	Other Indications
<p>Alarm Concentration of gas rises above the Alarm setting.</p>	<ul style="list-style-type: none"> • Affected channel's gas reading flashes and the units field alternates between the units and AL2 • Alarm LEDs flash in circle sequence twice per second • Backlight turns on 	<ul style="list-style-type: none"> • High-low tone sounding twice per second • Vibrator pulses twice per second
<p>Alarm H Concentration of gas rises above the Alarm H setting or falls below the Alarm H setting for O₂.</p>	<ul style="list-style-type: none"> • Affected channel's gas reading flashes and the units field alternates between the units and AL3 • Alarm LEDs flash in circle sequence twice per second • Backlight turns on 	<ul style="list-style-type: none"> • High-low tone sounding twice per second • Vibrator pulses twice per second
<p>TWA or STEL Concentration of CO, H₂S, CO₂, or super toxic gas rises above the TWA or STEL alarm setting.</p>	<ul style="list-style-type: none"> • Affected channel's gas reading flashes and the units field alternates between the units and TWA or STEL. • Alarm LEDs flash in circle sequence once per second • Backlight turns on 	<ul style="list-style-type: none"> • High-low tone sounding once per second • Vibrator pulses once per second
<p>Over Range</p>	<ul style="list-style-type: none"> • Affected channel's gas reading is replaced by flashing OVER and the units field alternates between the units and OVER. • Alarm LEDs flash in circle sequence twice per second • Backlight turns on 	<ul style="list-style-type: none"> • High-low tone sounding twice per second • Vibrator pulses twice per second
<p>Minus Over Range</p>	<ul style="list-style-type: none"> • Affected channel's gas reading is replaced by flashing -OVER and the units field alternates between the units and MOVER. • Alarm LEDs flash in circle sequence twice per second • Backlight turns on 	<ul style="list-style-type: none"> • High-low tone sounding twice per second • Vibrator pulses twice per second
<p>Low Battery Warning</p>	<ul style="list-style-type: none"> • The last bar in the battery icon disappears and the battery icon starts flashing 	<p>None</p>
<p>Dead Battery Alarm</p>	<ul style="list-style-type: none"> • Gas readings disappear and FAIL BATTERY appears at the bottom of the LCD • Alarm LEDs flash once per second 	<p>Double pulsing tone once per second</p>
<p>Sensor Failure</p>	<ul style="list-style-type: none"> • FAIL SENSOR appears at the bottom of the LCD and the failed sensor(s) are indicated with FAIL under the gas name. • Alarm LEDs flash once per second 	<p>Double pulsing tone once per second</p>

Table 10: Alarm Types and Indications

Alarm Type		Visual Indications	Other Indications
Clock Failure		<ul style="list-style-type: none"> • FAIL CLOCK appears at the bottom of the LCD • Alarm LEDs flash once per second 	Double pulsing tone once per second
System Failure		<ul style="list-style-type: none"> • FAIL SYSTEM appears at the bottom of the LCD and an error code displays in the middle of the LCD • Alarm LEDs flash once per second 	Double pulsing tone once per second
Man Down Warning 1 The WARNING 1 TIME defined in User Mode has passed since the instrument detected movement.		<ul style="list-style-type: none"> • Alarm LEDs flash once per second 	Single pulsing tone once per second
Man Down Warning 2 The WARNING 2 TIME defined in User Mode has passed since the instrument detected movement.		<ul style="list-style-type: none"> • Alarm LEDs flash twice per second 	Single pulsing tone twice per second
Man Down Alarm The ALARM TIME defined in User Mode has passed since the instrument detected movement.		<ul style="list-style-type: none"> • MAN DOWN appear at the bottom of the LCD and the gas readings disappear • Alarm LEDs flash in circle sequence twice per second • Backlight turns on 	<ul style="list-style-type: none"> • High-low tone sounding twice per second • Vibrator pulses twice per second
Panic User double taps the instrument.	Pre Alarm	<ul style="list-style-type: none"> • Screen unaffected for 5 seconds • Alarm LEDs flash twice per second 	<ul style="list-style-type: none"> • Single pulsing tone twice per second for 5 seconds
	Main Alarm	<ul style="list-style-type: none"> • PANIC appears at the bottom of the LCD and the gas readings disappear • Alarm LEDs flash in circle sequence twice per second • Backlight turns on 	<ul style="list-style-type: none"> • High-low tone sounding twice per second • Vibrator pulses twice per second

Responding to Alarms

This section describes response to gas, over range, battery, sensor failure, clock failure, system failure, man down, and panic alarms.

Responding to Gas Alarms

1. Determine which gas alarm has been activated.
2. Follow your established procedure for an increasing gas condition or a decreasing oxygen condition.
3. Reset the alarm as necessary or allowed.
 - a. If **LATCHING** is set to **ON** (factory setting) in Maintenance Mode, the gas reading must fall below (or rise above for an oxygen low alarm) an alarm setting before you can reset the alarm condition using **POWER MODE** or **AIR**.

- b. If **LATCHING** is set to **OFF** in Maintenance Mode, the alarm condition will automatically reset when gas reading falls below (or rises above for an oxygen low alarm) an alarm setpoint.

Responding to Over Range Alarms

WARNING: *An over range condition may indicate an extreme combustible gas, toxic gas, or oxygen concentration. Confirm the gas concentration with a different GX-3R Pro or with another gas detecting device.*

CAUTION: *High off-scale readings may indicate an explosive concentration.*

PRUDENCE: *Des lectures élevées hors échelle peuvent indiquer une concentration explosive.*

1. Determine which channel is in alarm.
2. Follow your established procedure for an extreme gas condition.
3. If **LATCHING** is set to **ON** (factory setting) in Maintenance Mode, reset the alarm using **POWER MODE** or **AIR** once the alarm condition has cleared.
4. Calibrate the GX-3R Pro as described on pg.57.
5. If the over range condition continues or if you are not able to successfully calibrate the unit, you may need to replace the sensor that has triggered the over range alarm.
6. If the over range condition continues after you have replaced the sensor, contact RKI Instruments, Inc. for further instructions.

Responding to Battery Alarms

WARNING: *The GX-3R Pro is not operational as a gas monitoring device during a dead battery alarm. Take the Model GX-3R Pro to a non-hazardous area and replace or recharge the batteries as described in “Replacing the Batteries (Alkaline Version)” on page 93.*

The GX-3R Pro is fully functional during a low battery warning. However, only a limited amount of operating time remains, approximately 1 - 2 hours. The amount of time depends on how often the LCD backlight is used and how often the unit is responding to alarm conditions. Recharge the Li-ion battery pack (pg.94) or replace the alkaline batteries (pg.93) as soon as possible.

NOTE: Alarms and the LCD back light consume battery power and reduce the amount of operating time remaining.

Responding to Sensor Failure Alarms

1. Determine which sensor has triggered the sensor failure alarm.
2. Try calibrating the failed sensor, as described on pg.57 before replacing it.
3. If the sensor failure continues, replace the sensor as described on pg.98
4. If the sensor failure condition continues after you have replaced the sensor, contact RKI Instruments, Inc. for further instructions.

Responding to Clock Failure Alarms

A clock failure alarm occurs if the unit's internal clock malfunctions.

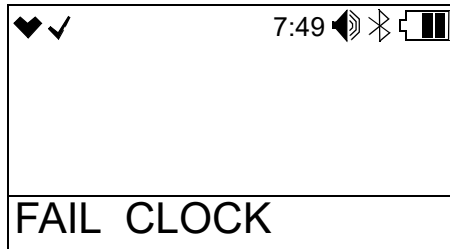

1. Press and release POWER MODE to continue into Measuring Mode.

CAUTION: *There will be no datalogging function if you operate the instrument after a clock failure.*

2. Attempt to set the date using the **DATE** User Mode menu item as described on pg.87.
3. If the date cannot be set correctly, contact RKI Instruments, Inc. as soon as possible.

Responding to System Failure Alarms

1. If a system failure occurs, the system failure screen will display an error code as shown below:

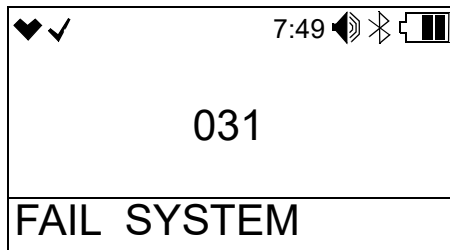

2. The error code meanings are shown in the table below:

Table 11: Error Code Explanation

Error Code	Explanation
000	ROM failure
010	RAM failure
021	FRAM failure
031	FLASH memory failure
080	Acceleration sensor failure
081	PCB failure
082	Temperature sensor failure
083	Bluetooth failure

3. If the error code is anything but 031 as shown above, the instrument cannot be used. Contact RKI Instruments, Inc. as soon as possible.

If the error code is 031, you may press and release POWER MODE to continue into Measuring Mode if the instrument must be used temporarily.

CAUTION: *There will be no datalogging function if you operate the instrument after a 031 system failure. Contact RKI Instruments, Inc. as soon as possible.*

Responding to a Man Down Warning 1 and Warning 2

The Man Down Warning 1 and Warning 2 alarms occur after the **WARNING 1 TIME** and **WARNING 2 TIME**, respectively, has passed since the last movement of the instrument. See pg.77 for instructions to change these values.

1. Follow your established procedure for a man down warning.
2. To silence the alarm and reset the Man Down clock, move the instrument or press and release POWER MODE.

Responding to a Man Down Alarm

The Man Down Alarm alarms occur after the **ALARM TIME** has passed since the last movement of the instrument. See pg.77 for instructions to change this value.

1. Follow your established procedure for a man down alarm.
2. To silence the alarm and reset the Man Down clock, press and release POWER MODE or AIR. Moving the instrument will not reset the alarm or Man Down clock.

Responding to a Panic Alarm

If the user is in a dangerous situation or feels that others must be alerted to any sort of problem, forcefully tapping the instrument twice will initiate a panic alarm.

1. Press and release POWER MODE or AIR to silence and reset the alarm.

Data Logging

The GX-3R Pro features the ability to log data to its internal memory and download it to a computer via the infrared communications port on the front of the unit. It logs gas readings in Measuring Mode, alarm data, and calibration data.

To utilize the GX-3R Pro's downloading capability, you will need the GX-3R Data Logger Management Program and a computer with an infrared port or a USB port that runs one of the following operating systems: Windows 7, Windows 8, or Windows 10. If your computer has an infrared port, then no additional accessories are needed to download data from the GX-3R Pro. If your computer does not have an infrared port but does have a USB port, a USB/IrDA adapter cable can be used to download data from the GX-3R Pro using the USB port. The GX-3R Data Logger Management Program is available at www.rkiinstruments.com/gx3rpro. The USB/IrDA adapter cable is available from RKI Instruments, Inc.

The data logging capacity depends on how often the GX-3R Pro stores data, how many channels are active, and how often the GX-3R Pro is turned on and off. The table below illustrates how much data logging time is available for the various interval times. It assumes that the unit has four sensors, is only turned on once, and there are no alarm occurrences. The data logging interval time must be set using the GX-3R Data Logger Management Program.

Table 12: Data Logging Capacity

Interval Time	Data Logging Time
10 seconds	10 hours
20 seconds	20 hours
30 seconds	30 hours
1 minute	60 hours
3 minutes	180 hours
5 minutes	300 hours
10 minutes	600 hours

For a complete description of the Data Logger Management Program and procedures for downloading data to a computer, see the GX-3R Data Logger Management Program Operator's Manual.

Chapter 4: Display Mode

This section describes Display Mode which is accessible from Measuring Mode. See Table 13 below for a list of Display Mode's menu items, a short description of each item, and the page number for further description.

Table 13: Display Mode Menu Items

Display Mode Menu Item	Description
PEAK (pg.36)	Displays the Peak readings for each sensor.
STEL (pg.36)	Displays the STEL readings (CO, H ₂ S, and CO ₂ /super toxic only).
TWA (pg.37)	Displays the TWA readings (CO, H ₂ S, and CO ₂ /super toxic only).
HC GAS LIST (pg.37) ^A	Change the target gas for the catalytic sensor. <ul style="list-style-type: none"> • CH₄ (methane) • i-C₄H₁₀ (isobutane) • H₂ (hydrogen) • CH₃OH (methanol) • C₂H₂ (acetylene) • C₂H₄ (ethylene) • C₂H₆ (ethane) • C₂H₅OH (ethanol) • C₃H₆ (propylene) • C₃H₆O (acetone) • C₃H₈ (propane) • C₄H₆ (butyne) • C₅H₁₀ (cyclopentane) • C₆H₆ (benzene) • n-C₆H₁₄ (hexane) • C₇H₈ (toluene) • n-C₇H₁₆ (heptane) • C₈H₁₀ (xylene) • n-C₉H₂₀ (nonane) • EtAc (ethyl acetate) • IPA (isopropyl alcohol) • MEK (methyl ethyl ketone) • MMA (methyl methacrylate) • DME (dimethyl ether) • MIBK (methyl isobutyl ketone) • THF (tetrahydrofuran)
USER ID (pg.38) ^B	View and/or change the User ID.
STATION ID (pg.39) ^B	View and/or change the Station ID.
CAL DATA (pg.40) ^C	Displays the last calibration date for each sensor.
BUMP DATA (pg.41) ^D	Displays the last bump test date for each sensor.
DATE (pg.42)	Displays the current date, time, and temperature.
ALARM POINTS (pg.42)	View alarm points
INVERT SELECT (pg.43) ^A	<p>ON: The LCD stays upside down relative to the instrument.</p> <p>AUTO: The LCD automatically flips as the instrument is rotated to remain readable whether the instrument is right side up or upside down.</p> <p>OFF (factory setting): The LCD stays right side up relative to the instrument.</p>

Table 13: Display Mode Menu Items

Display Mode Menu Item	Description
LCD BACK-GROUND (pg.44) ^A	ON : LCD has black background with white characters. OFF (factory setting): LCD has white background with black characters.
BLUETOOTH (pg.44) ^A	ON : Turns Bluetooth functionality on. OFF (factory setting): Turns Bluetooth functionality off.
BUZZER VOLUME (pg.45) ^A	HIGH (factory setting): Buzzer volume is high. LOW : Buzzer volume is low.
LANGUAGE (pg.46) ^E	Change the language of the instrument back to English if something other than English was selected in User Mode.
<p>^A Only appears if D MODE SETTING is set to ON in User Mode (factory setting) and if CH4 or i-C4H10 is selected for the combustible gas in Gas Select Mode.</p> <p>^B Only appears if D MODE SETTING is set to ON in User Mode (factory setting) <u>and</u> if ID DISPLAY is set to ON in Maintenance Mode (factory setting is OFF).</p> <p>^C Only appears if CAL REMINDER is set to ON in User Mode (factory setting).</p> <p>^D Only appears if BUMP REMINDER is set to ON in User Mode (factory setting is OFF).</p> <p>^E Only appears if LANGUAGE is set to something other than ENGLISH in Maintenance Mode.</p>	

Tips for Using Display Mode

- To enter Display Mode and scroll from one menu item to the next or skip an item when a question is asked, press and release POWER MODE.
- To enter an item, press and release AIR.
- To change a flashing parameter, use AIR. To reverse the direction of movement in a list (ie. from down to up or vice versa):
 - a. Press and hold AIR.
 - b. Immediately press POWER MODE and then release both buttons.
- To exit from an entered-information screen and go back to the main menu, press and release POWER MODE.

NOTE: Each screen displays for 20 seconds. If you do not press a button within 20 seconds, the GX-3R Pro automatically returns to Measuring Mode.

Peak Screen (PEAK)

The peak screen displays the highest (lowest for oxygen) concentrations detected since the GX-3R Pro was turned on. Peak readings are stored in the GX-3R Pro's memory until a higher level is detected (lower for oxygen), the peak reading is cleared, or the GX-3R Pro is turned off.

The lunch break feature enables the GX-3R Pro to save peak readings when it is turned off so it can continue with the same peaks when it is turned on again. See pg.81 for instructions to turn the lunch break feature on (default is off).

♥✓		7:49		🔊 🔌 🔋	
CH4	%LEL	CO	ppm	H2S	ppm
	12		7		23.0
O2	%	CO2	vol%		
	18.7		5.50		
PEAK					

To clear the peak readings, do the following:

1. While in Display Mode, press and release POWER MODE until **PEAK** appears.
2. Press and hold AIR until the screen prompts you to release it.

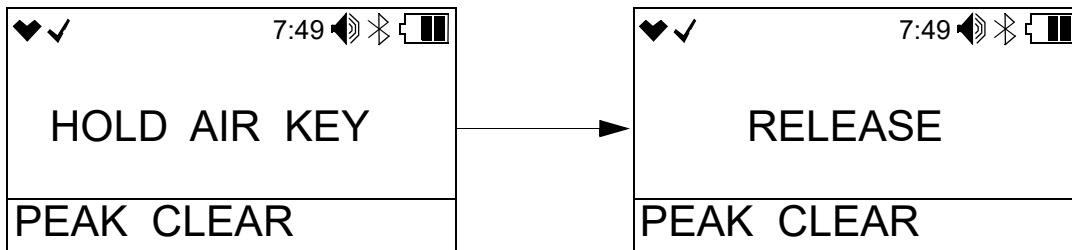

3. The peak readings will be reset and the unit will return to the Peak Screen.

If you do not want to clear the peak readings, release AIR before the above screen sequence occurs. The unit will return to the Peak Screen.

STEL Screen (STEL)

The STEL Screen displays the short term exposure limit (STEL) readings for H_2S , CO , CO_2 , and super toxic only. The STEL reading is the average reading over the last 15 minutes.

♥✓		7:49		🔊 🔌 🔋	
	CO	ppm	H2S	ppm	
		2		3.0	
	CO2	vol%			
		1.50			
STEL					

TWA Screen (TWA)

The TWA Screen displays the time weighted average (TWA) readings for H_2S , CO , CO_2 , and super toxic only.

♥✓	7:49	🔊	🔇	🔋
	CO	ppm	H2S	ppm
		6		5.5
		CO2		vol%
				0.75
TWA				

The TWA reading is the average reading over the last 8 hours. If 8 hours have not elapsed since the last time the TWA reading was cleared, the average is still calculated over 8 hours. The missing time is assigned a 0 value for readings. If **LUNCH BREAK** is set to **OFF** (factory setting), the TWA is cleared when the GX-3R Pro is turned off.

If **LUNCH BREAK** is set to **ON**, the GX-3R Pro will remember TWA readings when it is turned off so it can continue them when it is turned on again. See pg.81 for instructions to turn the lunch break feature on (default is off).

HC GAS LIST

The **HC GAS LIST** screen allows you to select the target gas for the combustible gas sensor. This screen only appears if **D MODE SETTING** in User Mode is set to **ON** (factory setting) and if CH_4 or iC_4H_{10} is selected for the combustible channel in Gas Select Mode.

If you select a new target gas, the change is saved if you turn the instrument off and on.

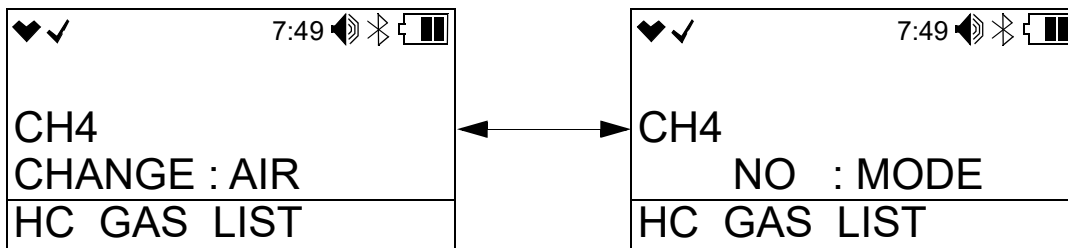

1. While in Display Mode, press and release **POWER MODE** until **HC GAS LIST** appears. The current setting is displayed on the top line.
2. Press and release **AIR** to enter the screen. The cursor will be to the left of the current gas selection.

♥✓	7:49	🔊	🔇	🔋
>	CH4			
	i-C4H10			
	H2			
HC GAS LIST				

- Use AIR to scroll through the list of gases.

• CH ₄ (methane)	• C ₆ H ₆ (benzene)
• i-C ₄ H ₁₀ (isobutane)	• n-C ₆ H ₁₄ (hexane)
• H ₂ (hydrogen)	• C ₇ H ₈ (toluene)
• CH ₃ OH (methanol)	• n-C ₇ H ₁₆ (heptane)
• C ₂ H ₂ (acetylene)	• C ₈ H ₁₀ (xylene)
• C ₂ H ₄ (ethylene)	• n-C ₉ H ₂₀ (nonane)
• C ₂ H ₆ (ethane)	• EtAc (ethyl acetate)
• C ₂ H ₅ OH (ethanol)	• IPA (isopropyl alcohol)
• C ₃ H ₆ (propylene)	• MEK (methyl ethyl ketone)
• C ₃ H ₆ O (acetone)	• MMA (methyl methacrylate)
• C ₃ H ₈ (propane)	• DME (dimethyl ether)
• C ₄ H ₆ (butyne)	• MIBK (methyl isobutyl ketone)
• C ₅ H ₁₀ (cyclopentane)	• THF (tetrahydrofuran)

- When the desired gas is displayed, press and release POWER MODE. The changes are saved and the instrument returns to the **HC GAS LIST** screen.
- The gas formula displays at the bottom of the Measuring Mode screen. The gas selection remains in effect if you turn the instrument off and on again.

User ID Screen (USER ID)

This screen only appears if **D MODE SETTING** in User Mode is set to **ON** (factory setting) and if **ID DISPLAY** in Maintenance Mode is set to **ON** (factory setting is **OFF**).

Use this screen to select a user ID from the 128 user IDs that are stored in the GX-3R Pro's memory. Before a user ID is selected on a brand new instrument, the user ID is "-----". The factory-installed user IDs have a "U_ID_XXX" format.

The user ID provides a way to identify the GX-3R Pro user during a data logging session. If the user ID is changed during an operating session, a new data session is initiated with the new user ID attached to it.

User IDs can only be selected in this menu item. In order to edit the 128 user IDs, you must use the GX-3R Datalogging Program.

- After entering Display Mode, press and release POWER MODE until **USER ID** appears.

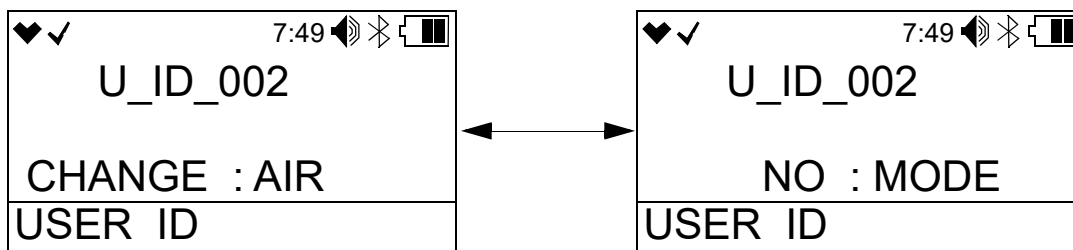

2. To change the User ID, press and release AIR. The current User ID will flash.

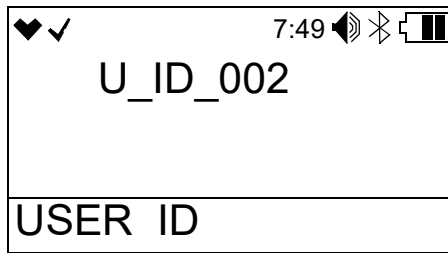

3. Use AIR to scroll to the desired User ID. To reverse the scrolling direction:
 - a. Press and hold AIR.
 - b. Immediately press POWER MODE and then release both buttons.
4. Press and release POWER MODE to save the User ID and return to the **USER ID** screen in Display Mode.

Station ID Screen (STATION ID)

This screen only appears if **D MODE SETTING** in User Mode is set to **ON** (factory setting) and if **ID DISPLAY** in Maintenance Mode is set to **ON** (factory setting is **OFF**).

Use this screen to select a station ID from the 128 station IDs that are stored in the GX-3R Pro's memory. Before a station ID is selected on a brand new instrument, the station ID is "-----". The factory-installed station IDs have a "S_ID_XXX" format.

The station ID provides a way to identify the GX-3R Pro location during a data logging session. If the station ID is changed during an operating session, a new data session is initiated with the new station ID attached to it.

User IDs can only be selected in this menu item. In order to edit the 128 user IDs, you must use the GX-3R Datalogging Program.

1. After entering Display Mode, press and release POWER MODE until **STATION ID** appears.

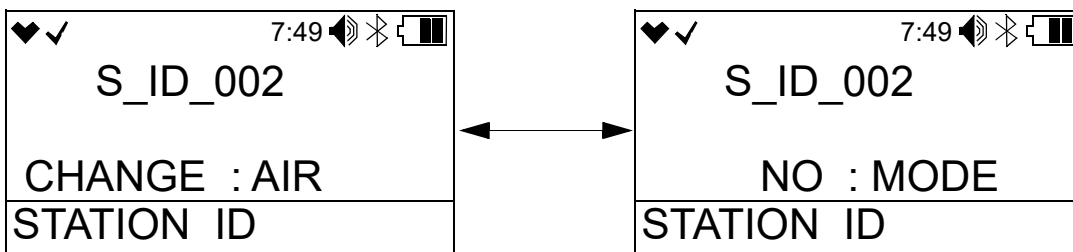

2. To change the Station ID, press and release AIR. The current Station ID will flash.

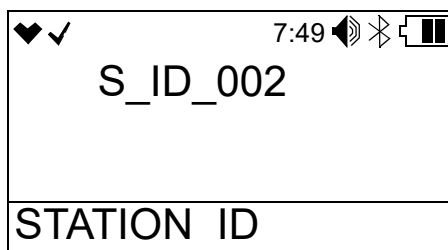

3. Use AIR to scroll to the desired Station ID. To reverse the scrolling direction:
 - a. Press and hold AIR.
 - b. Immediately press POWER MODE and then release both buttons.
4. Press and release POWER MODE to save the Station ID and return to the **STATION ID** screen in Display Mode.

Last Successful Calibration Date (CAL DATA)

The **CAL DATA** screen shows the date of the last successful calibration for each of the installed sensors. This screen only appears if **CAL REMINDER** is set to **ON** in User Mode.

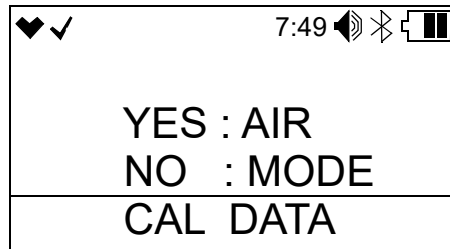

1. While in Display Mode, press and release POWER MODE until **CAL DATA** appears.
2. Press AIR to enter the **CAL DATA** screen and to scroll through the installed sensors.

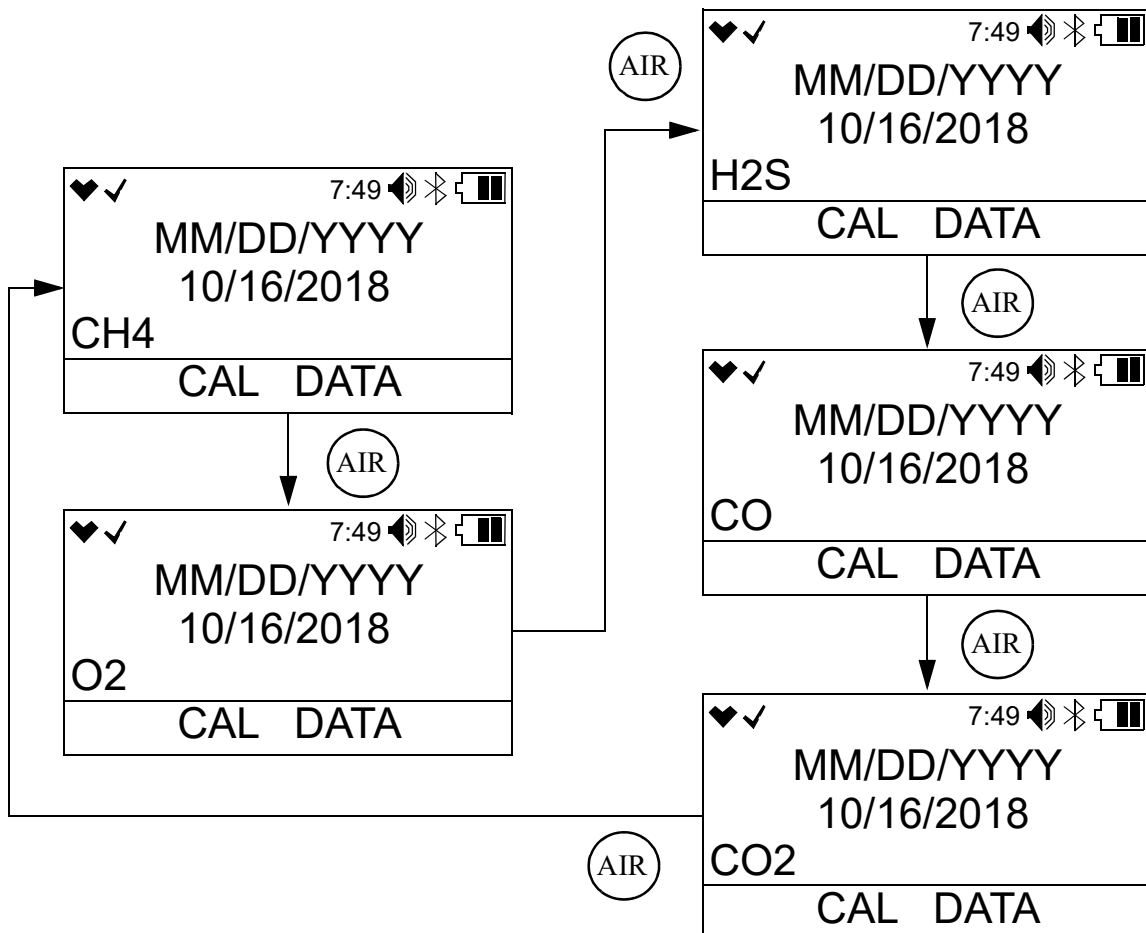

- When you are done viewing the last calibration date for the sensors, press and release **POWER MODE** to return to the **CAL DATA** screen in Display Mode.

Last Successful Bump Test Date (BUMP DATA)

The **BUMP DATA** screen shows the date of the last successful bump test for each of the installed sensors. This screen only appears if **BUMP REMINDER** is set to **ON** in User Mode.

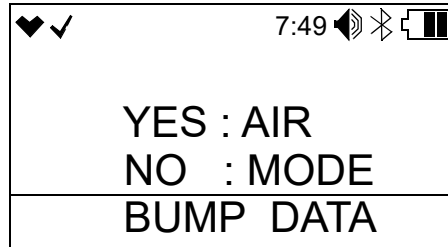

- While in Display Mode, press and release **POWER MODE** until **BUMP DATA** appears.
- Press **AIR** to enter the **BUMP DATA** screen and to scroll through the installed sensors.

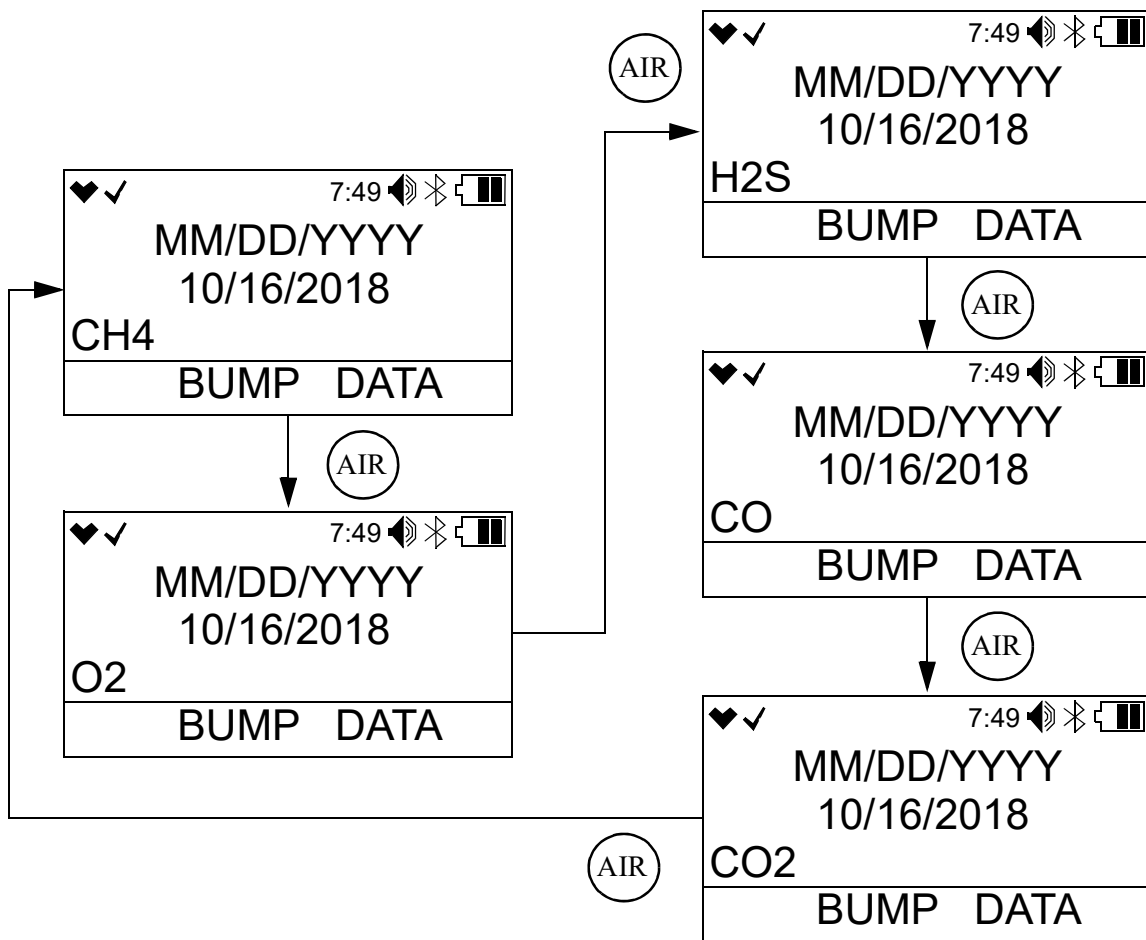

- When you are done viewing the last bump test date for the sensors, press and release **POWER MODE** to return to the **BUMP DATA** screen in Display Mode.

Date, Time, Temperature Screen (DATE)

The **DATE** screen shows the date and time of the instrument and the temperature of the surrounding area.

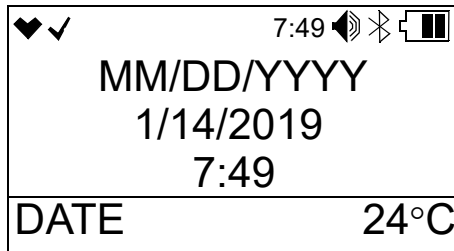

- 1 . While in Display Mode, press and release **POWER MODE** until **DATE** appears.

Alarm Points Screen (ALARM POINTS)

The Alarm Points Screen allows you to view the gas alarm settings for all active channels.

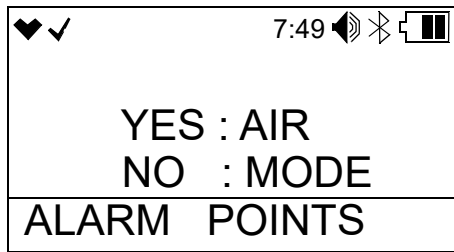

- 1 . While in Display Mode, press and release **POWER MODE** until **ALARM POINTS** appears.
- 2 . Press and release **AIR** to enter the Alarm Points screen. The Full Scale Settings screen will appear showing full scale settings for each channel.

3. Use AIR to scroll through the Warning, Alarm, Alarm H, STEL, and TWA settings.

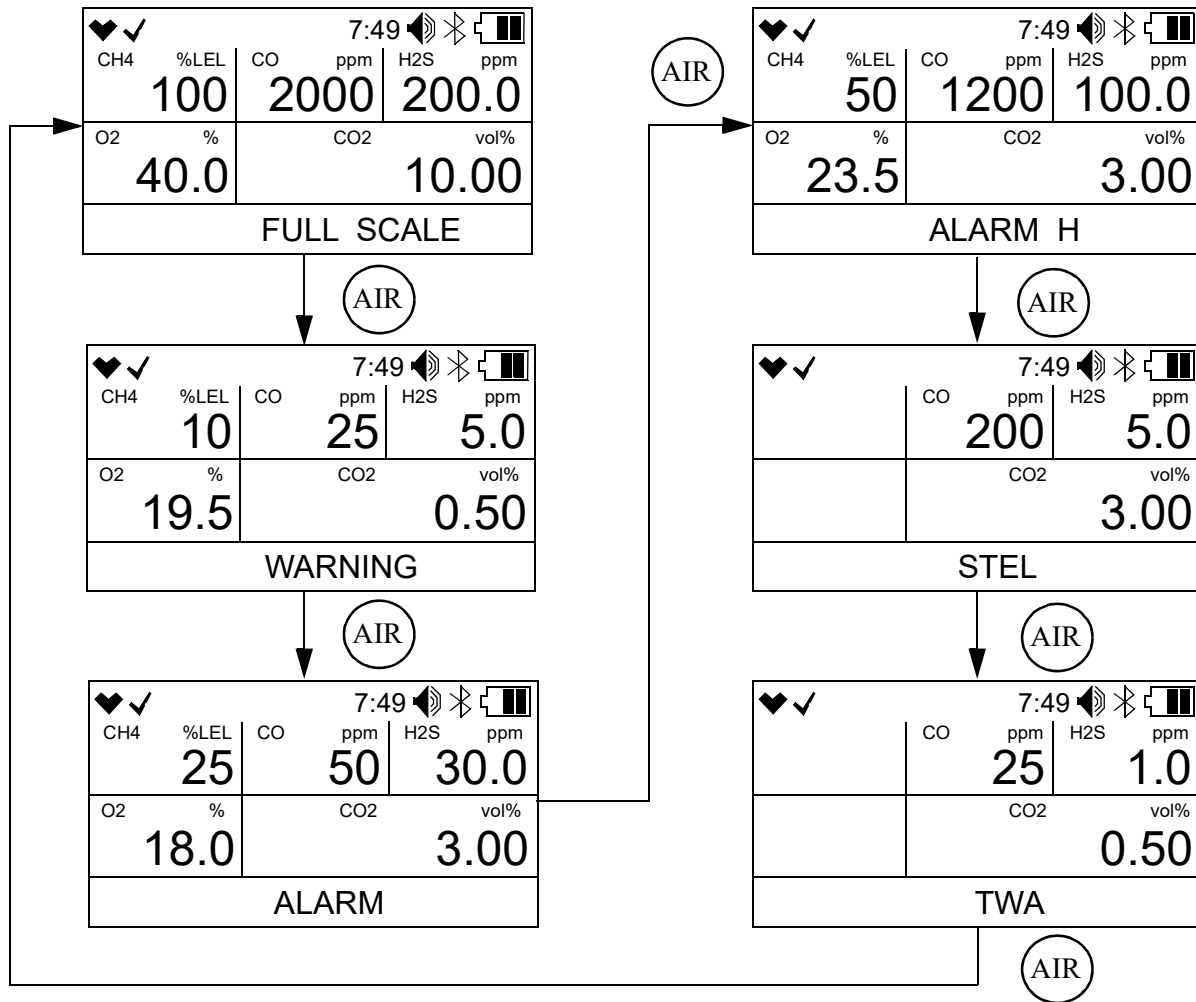

4. Press and release POWER MODE to return to the **ALARM POINTS** item in Display Mode.

Screen Inversion On/Off (INVERT SELECT)

The **INVERT SELECT** screen allows you to turn the screen inversion function on or off. This screen only appears if **D MODE SETTING** in User Mode is set to **ON** (factory setting).

ON: The LCD stays upside down relative to instrument.

AUTO: The LCD automatically flips to remain readable whether the instrument is right side up or upside down.

OFF (factory setting): The LCD stays right side up relative to the instrument.

1. While in Display Mode, press and release POWER MODE until **INVERT SELECT** appears. The current setting is displayed on the top line.

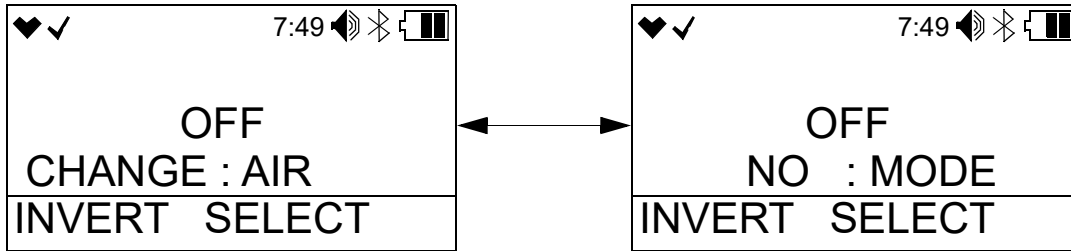

2. Press and release AIR. The current setting flashes.
3. Use AIR to display the desired setting.
4. Press and release POWER MODE to save the setting and return to the **INVERT SELECT** screen.

LCD Color Scheme (LCD BACKGROUND)

The **LCD BACKGROUND** screen allows you to change the appearance of the LCD. This screen only appears if **D MODE SETTING** in User Mode is set to **ON** (factory setting).

ON: LCD has black background with white characters.

OFF (factory setting): LCD has white background with black characters.

1. While in Display Mode, press and release POWER MODE until **LCD BACKGROUND** appears. The current setting is displayed on the top line.

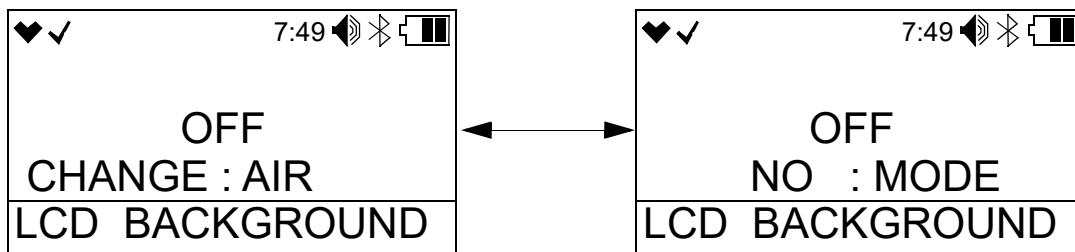

2. Press and release AIR. The current setting flashes.
3. Use AIR to display the desired setting.
4. Press and release POWER MODE to save the setting. The **LCD BACKGROUND** menu item will be displayed.

Turning Bluetooth On/Off (BLUETOOTH)

The **BLUETOOTH** screen allows you to turn the GX-3R Pro's Bluetooth functionality on and off. This screen only appears if **D MODE SETTING** in User Mode is set to **ON** (factory setting).

ON: Turns Bluetooth functionality on, allowing for connection to the RK Link app on your phone.

OFF (factory setting): Turns Bluetooth functionality off.

1. While in Display Mode, press and release POWER MODE until **BLUETOOTH** appears. The current setting is displayed on the top line.

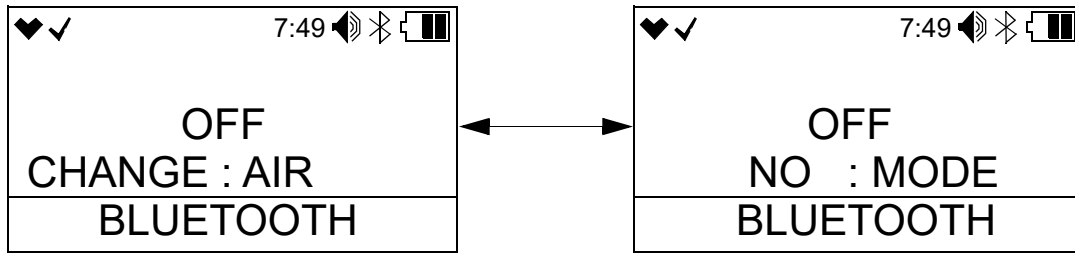

2. Press and release AIR. The current setting flashes.
3. Use AIR to display the desired setting.
4. Press and release POWER MODE to save the setting and return to the **BLUETOOTH** screen.

Adjusting the Buzzer Volume (BUZZER VOLUME)

The **BUZZER VOLUME** screen allows you to adjust the volume of the instrument's buzzer. This screen only appears if **D MODE SETTING** in User Mode is set to **ON** (factory setting).

HIGH (factory setting): Buzzer volume is high.

LOW: Buzzer volume is low.

1. While in Display Mode, press and release POWER MODE until **BUZZER VOLUME** appears. The current setting is displayed on the top line.

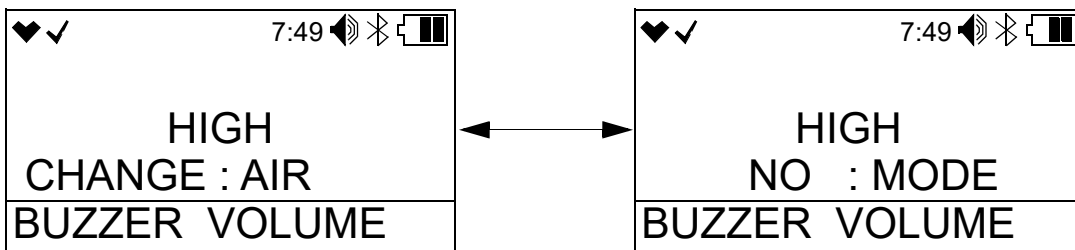

2. Press and release AIR. The current setting flashes.
3. Use AIR to display the desired setting.
4. Press and release POWER MODE to save the setting. The **BUZZER VOLUME** menu item will be displayed.

Changing Instrument Language Back to English (LANGUAGE)

This screen only appears if the **LANGUAGE** item in Maintenance Mode is set to something other than **ENGLISH**.

1. While in Display Mode, press and release **POWER MODE** until the **LANGUAGE** screen appears.

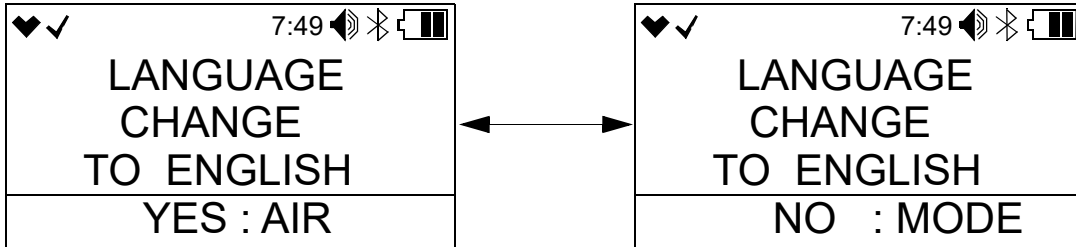

2. Press and release **AIR**.

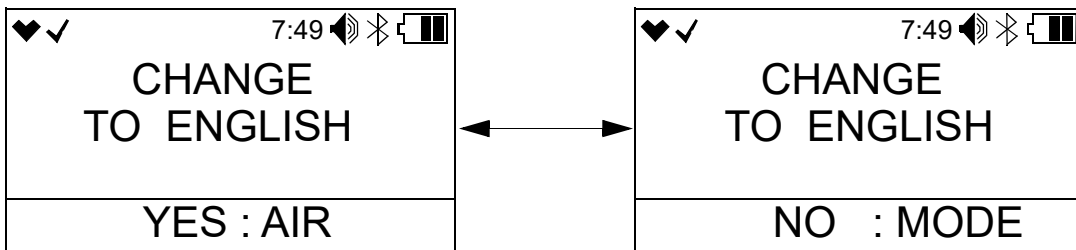

3. Press and release **POWER MODE** to confirm that you want to change the language back to English.

Chapter 5: User Mode and Calibration

Overview

This section describes the GX-3R Pro in User Mode. See Table 14 below for a list of the items found in User Mode, the page that the menu item's instructions can be found on, and a short description of the menu item.

Table 14: User Mode Menu Items

User Mode Menu Item	Description		
BUMP TEST (pg.53)	Perform a bump test.		
GAS CAL (pg.57)	Perform a fresh air adjustment, perform a span adjustment, change the calibration gas concentration, set the cylinder group.		
	AIR CAL (pg.57)	Perform a fresh air adjustment.	
	CO2 ZERO CAL (pg.58)***	Perform a zero adjustment on the CO ₂ channel using 100% nitrogen.	
	AUTO CAL (pg.60)	AUTO CAL CYL X	Perform an automatic span adjustment on the gases selected for Cylinder X (A-E cylinders available).
		SETTING CAL-P	Set the calibration gas concentration for each gas.
		CYL SETTING	Assign a cylinder (A-E) to each gas. Multiple gases can be assigned to the same cylinder.
		ESCAPE	Return to the AUTO CAL menu item.
ESCAPE	Return to the GAS CAL menu item.		
CAL SETTING (pg.68)	Change parameters related to calibration.		
	CAL REMINDER (pg.68)	ON (factory setting): The instrument will notify the user upon startup when a calibration is due. Notification type depends on CAL EXPD setting below. OFF: No notification upon startup when a calibration is due.	
	CAL INTERVAL (pg.69)	How often the instrument needs to be calibrated. Options: 1 - 1000 days (factory setting is 90 days)	
	CAL EXPIRED (pg.69)	Defines what action must be taken if a calibration is due upon startup. CONFIRM TO USE (factory setting): Press and release POWER MODE to acknowledge that calibration is due and continue to Measuring Mode. CANNOT USE: Cannot enter Measuring Mode until a successful calibration is performed. NO EFFECT: A screen indicates that calibration is due but warmup sequence continues.	

Table 14: User Mode Menu Items

User Mode Menu Item	Description		
CAL SETTING (cont'd)	CAL CHECK GAS (pg.70)	<p>ALL GAS (factory setting): Calibration dates for all gases are used to determine if calibration is due.</p> <p>4 GAS: Calibration dates for only the standard 4 gases (combustible gas/O₂/H₂S/CO) are used to determine if calibration is due.</p>	
	ESCAPE	Return to the CAL SETTING menu item in User Mode.	
BUMP SETTING (pg.70)	Change parameters related to bump testing.		
	BUMP PARAMETER (pg.71)	GAS TIME	How long gas is applied during a bump test. Choices: 30 (factory setting), 45 , 60 , 90 seconds
		TOLERANCE	Percentage of calibration gas concentration that the bump test reading must be within in order to pass bump. Options: 10% , 20% , 30% , 40% , 50% (factory setting)
		CAL TIME	How long gas is applied during a calibration. GAS TIME is deducted from this time. Options: 90 (factory setting) or 120 seconds
		AUTO CAL	<p>ON (factory setting): If a bump test fails, a calibration is automatically started.</p> <p>OFF: If a bump test fails, a calibration is not automatically started.</p>
		ESCAPE	Return to the BUMP PARAMETER menu item in BUMP SETTINGS .
	BUMP REMINDER (pg.73)	<p>ON: The instrument will notify the user upon startup when a bump test is due. Notification type depends on BUMP EXPIRED setting below.</p> <p>OFF (factory setting): No notification upon startup when a bump test is due.</p>	
	BUMP INTERVAL (pg.73)	How often the instrument needs to be bump tested. Options: 0 - 30 days (factory setting is 30 days)	
	BUMP EXPIRED (pg.74)	<p>Defines what action must be taken if a bump test is due upon startup.</p> <p>CONFIRM TO USE (factory setting): Press and release POWER MODE to acknowledge that bump test is due and continue to Measuring Mode.</p> <p>CANNOT USE: Cannot enter Measuring Mode until a successful bump test is performed.</p> <p>NO EFFECT: A screen indicates that bump test is due but warmup sequence continues.</p>	
	BUMP CHECK GAS (pg.74)	<p>ALL GAS (factory setting): Bump test dates for all gases are used to determine if bump test is due.</p> <p>4 GAS: Bump test dates for only the standard 4 gases (combustible gas/O₂/H₂S/CO) are used to determine if bump test is due.</p>	
ESCAPE	Return to the BUMP SETTING menu item in User Mode.		

Table 14: User Mode Menu Items

User Mode Menu Item	Description		
MAN DOWN (pg.75)	Turn the man down and panic alarms on and off. Set the intervals for man down alarms.		
	MAN DOWN (pg.76)	<p>ON: Man down alarm is triggered if the instrument does not detect motion during time period defined in WARNING 1 TIME, WARNING 2 TIME, and ALARM TIME below.</p> <p>OFF (factory setting): No man down alarm triggered.</p>	
	PANIC (pg.76)	<p>ON: Panic alarm can be triggered.</p> <p>OFF (factory setting): Panic alarm cannot be triggered.</p>	
	MAN DOWN TIME (pg.77)	ALARM TIME ≥ WARNING 2 TIME ≥ WARNING 1 TIME	
		WARNING 1 TIME	The amount of time that passes between a man down detection and the first warning alarm. Factory setting is 60 seconds.
		WARNING 2 TIME	The amount of time that passes between a man down detection and the second warning alarm. Factory setting is 75 seconds.
ALARM TIME	The amount of time that passes between a man down detection and a man down alarm. Factory setting is 90 seconds.		
ESCAPE	Return to the MAN DOWN menu item.		
ALARM SETTING (pg.78)	Set alarm points for all channels (WARNING, ALARM, ALARM H, STEL, TWA) or reset all alarms to their default settings.		
LUNCH BREAK (pg.81)	<p>ON: Lunch break feature is on. Instrument will ask if you want to resume TWA and PEAK readings at startup.</p> <p>OFF (factory setting): Lunch break feature is off. Instrument resets TWA and PEAK readings every time it's turned on.</p>		
CONFIRMATION (pg.82)	Set confirmation beep parameters.		
	BEEP SELECT (pg.82)	<p>LED: LEDs will flash and instrument will vibrate based on interval defined in BEEP INTERVAL to confirm instrument is still operating.</p> <p>BUZZER: Buzzer will sound and instrument will vibrate based on interval defined in BEEP INTERVAL to confirm instrument is still operating.</p> <p>LED+BUZZER: LEDs will flash, buzzer will sound, and instrument will vibrate based on interval defined in BEEP INTERVAL to confirm instrument is still operating.</p> <p>BUMP/CAL: LEDs flash based on interval defined in BEEP INTERVAL if bump test or calibration is due.</p> <p>ALARM ALERT: LEDs flash based on interval defined in BEEP INTERVAL if instrument goes into a gas alarm.</p> <p>BUMP/CAL/ALARM: LEDs flash based on interval defined in BEEP INTERVAL if a) bump test is due, b) calibration is due, or c) instrument goes into a gas alarm.</p> <p>OFF (factory setting): No alerts to confirm instrument is still operating or that a bump test or calibration are due.</p>	

Table 14: User Mode Menu Items

User Mode Menu Item	Description	
CONFIRMATION (cont'd)	BEEP INTERVAL (pg.83)	Confirmation alert interval. Confirmation type defined in BEEP SELECT . Options: 0.5 minute and 1 to 99 minutes in 1 minute increments. Factory setting is 5 minutes.
	ESCAPE	Return to the CONFIRMATION menu item in User Mode.
AUTO BACKLIGHT (pg.84)	ON (factory setting) : The instrument's backlight automatically turns on in a low light environment. OFF : The instrument's backlight will not automatically turn on in a low light environment.	
BACKLIGHT TIME (pg.84)	How long the back light stays on after the last button press. Options: 0 - 255 seconds or OFF . The factory setting is 30 seconds.	
KEY TONE (pg.85)	ON (factory setting) : Buzzer will sound when button is pressed. OFF : Buzzer will not sound when button is pressed.	
D MODE SETTING (pg.85)	OFF : LIST, USER ID, STATION ID, INVERT SELECT, LCD BACKGROUND, BLUETOOTH, BUZZER VOLUME, and LANGUAGE items do not appear in Display Mode. ON (factory setting) : LIST, INVERT SELECT, LCD BACKGROUND, BLUETOOTH, BUZZER VOLUME, and LANGUAGE items appear in Display Mode. USER ID and STATION ID screens appear if ID DISPLAY in Maintenance Mode is also set to ON .	
ZERO SUPPRESS (pg.86)*	ON (factory setting) : Not intended for field adjustment. The suppression values are: Combustible Gas: 2% LEL O ₂ : 0.5% volume H ₂ S: 0.3 ppm CO: 2 ppm CO ₂ : 0 ppm SO ₂ : 0.20 ppm	
ZERO FOLLOWER (pg.86)**	Not intended for field adjustment. The default setting is ON for every channel except oxygen. Oxygen channel does not support zero follower functionality.	
IR UNIT SELECT (pg.86)***	Select the units for the IR CO ₂ sensor. Options: vol% or ppm	
CO ₂ AIR SETTING (pg.87)***	ON : CO ₂ channel is set to 400 ppm (0.04% volume) when performing a demand zero, auto zero, or AIR CAL . OFF (factory setting) : CO ₂ channel is not adjusted during a demand zero, auto zero, or AIR CAL .	
DATE (pg.87)	Set the current date and time.	
DATE FORMAT (pg.88)	MM/DD/YYYY (factory setting) : month/day/year YYYY/MM/DD : year/month/day DD/MM/YYYY : day/month/year	
LANGUAGE (pg.88)	Set the language of the instrument. Options: English (factory setting), Japanese, Italian, Spanish, German, French, Portuguese, Russian, Korean, Chinese (TC)	

Table 14: User Mode Menu Items

User Mode Menu Item	Description
USER PASSWORD (pg.89)	ON: A password is needed to access User Mode. Factory-set password is 0405 . OFF (factory setting): No password is needed to access User Mode.
ROM/SUM (pg.90)	View the firmware information for the GX-3R Pro's sensor board and main board.
RADIO STANDARD (pg.90)	Approval numbers for radio agencies.
START MEASURE (pg.91)	Press and release POWER MODE to begin the warmup sequence and enter Measuring Mode.
<p>* Only appears if DISP ZERO SUP is set to ON in Maintenance Mode. ** Only appears if DISP ZERO FLWR is set to ON in Maintenance Mode. *** Only appears in units with a CO₂ sensor installed.</p>	

Entering User Mode

WARNING: *The GX-3R Pro is not in operation as a gas detector while in User Mode.*

1. Take the GX-3R Pro to a non-hazardous location and turn it off if it is on.
2. Press and hold AIR, then press and hold POWER MODE. When you hear a beep, release the buttons.
3. The screen that appears will depend on the setting of User Mode's **USER PASSWORD** item.

If **USER PASSWORD** is set to **OFF** (factory setting), continue with Step 6.

If **USER PASSWORD** is set to **ON**, continue with Step 4.

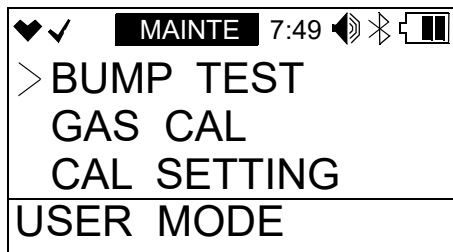

USER PASSWORD set to **OFF**



USER PASSWORD set to **ON**

4. If **USER PASSWORD** has been set to **ON** in User Mode, a password screen will appear. The first digit will be flashing.

5. Use AIR to select each password number then press POWER MODE to save it and move on to the next number. To go back a number, press and hold AIR and POWER MODE for a few seconds. To reverse the direction of change (ie. from increasing to decreasing or vice versa):
 - a. Press and hold AIR.
 - b. Immediately press POWER MODE and then release both buttons.
6. The User Mode menu displays.

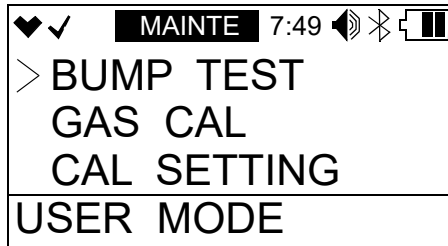

7. Use AIR to move through the User Mode menu items.

Tips for Using User Mode

- To scroll from one menu item to the next, press and release AIR. To reverse the scrolling direction:
 - a. Press and hold AIR.
 - b. Immediately press POWER/MODE and then release both buttons.
 - c. The scrolling direction returns to the original direction when you exit and reenter a menu.
- To skip an item when a question is asked, press and release AIR.
- To enter an item and to save any changes, press and release POWER MODE.
- To change a flashing parameter, use AIR. To reverse the direction of change (ie. from increasing to decreasing or vice versa):
 - a. Press and hold AIR.
 - b. Immediately press POWER MODE and then release both buttons.
- To exit an entered menu item without saving a change, press and hold AIR and POWER MODE for a few seconds.

Performing a Bump Test (BUMP TEST)

To bump test the GX-3R Pro, you will need:

- Known calibrating samples of the gases being detected. The combustible and toxic gas samples should have concentrations between 10 and 50% of the full scale value. For example, if you are bump testing the combustible gas channel, your calibration cylinder should have a combustible gas concentration between 10% LEL and 50% LEL. An oxygen-free source, such as 100% nitrogen is recommended for setting the oxygen zero but a concentration of up to 19.5% is acceptable.

CAUTION: *Although the GX-3R Pro can be bump tested with an oxygen concentration of up to 19.5%, RKI Instruments, Inc. recommends that a multi-gas cylinder have an oxygen concentration in the range of 10% - 16% oxygen.*

- A 0.25 LPM fixed flow regulator
 - Non-absorbent tubing
 - Calibration cup
1. Confirm that the GX-3R Pro's calibration gas values match the concentrations listed on the calibration gas cylinder(s) as described on pg.63.
 2. Confirm that your cylinder selections are appropriate as described on pg.65.
 3. Confirm that the regulator knob is turned all the way clockwise. Screw the 0.25 LPM fixed flow regulator onto the calibration cylinder.
 4. Install the calibration cup onto the GX-3R Pro. Use the label and imprinting to make sure that the calibration cup gets installed in the correct orientation relative to the GX-3R Pro. Be sure the calibration cup is pushed on all the way.

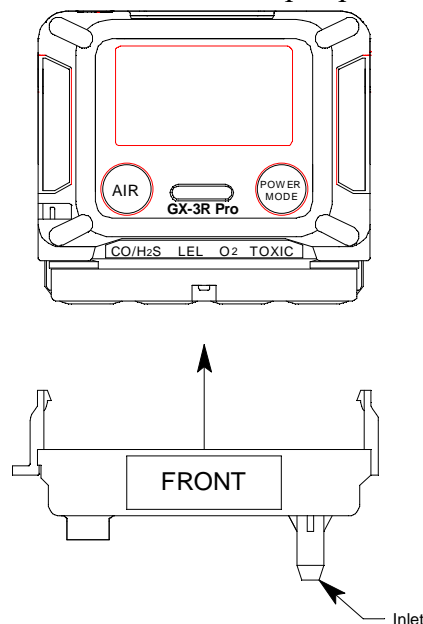

Figure 5: Calibration Cup Installation

5. Use the tubing to connect the regulator to the inlet of the calibration cup.

6. While in User Mode, use AIR to place the cursor next to **BUMP TEST**.

♥✓	MAINTE	7:49	🔊	📶	🔋
>	BUMP TEST				
	GAS CAL				
	CAL SETTING				
USER MODE					

7. Press and release POWER MODE. The display will show the gases assigned to Cylinder A and the assigned calibration values (see pg.63 if the calibration values do not match the calibration gas cylinder's concentrations).

♥✓	MAINTE	7:49	🔊	📶	🔋
CH4	%LEL	CO	ppm	H2S	ppm
	50	50		25.0	
O2	%				
	12.0				
BUMP TEST CYLINDER A					

8. If necessary, use AIR to scroll to the Auto Cal screen for the gas(es) you want to calibrate. As shipped from the factory, the standard 4 gases (combustible gas, O₂, CO, and H₂S) are assigned to Cylinder A. Hydrogen-compensated CO and other toxic sensors are assigned to Cylinder D or Cylinder E.
9. Turn the regulator knob counterclockwise to open the regulator.
10. With the appropriate Auto Cal screen displayed, press and release POWER MODE.
11. The gas readings will flash, the bottom of the screen will indicate "BUMP TEST" and "APPLY GAS", and the top of the screen will count down from the time defined in **BUMP SETTING\BUMP PARAMETER\GAS TIME**.

♥✓	MAINTE	30	🔊	📶	🔋
CH4	%LEL	CO	ppm	H2S	ppm
	0	0		0.0	
O2	%				
	20.9				
BUMP TEST APPLY GAS					

12. When the **BUMP SETTING\BUMP PARAMETER\AUTO CAL** User Mode menu item is set to:
- OFF**, continue to Step 13.
 - ON**, continue to Step 14.

13 . When the **BUMP SETTING\BUMP PARAMETER\AUTO CAL** User Mode menu item is set **OFF**:

- a. When the countdown is done, the instrument will indicate which channels passed or failed the bump test with a P (pass) or an F (fail) underneath the gas name. You can scroll between the bump test results and the bump test gas readings with AIR.

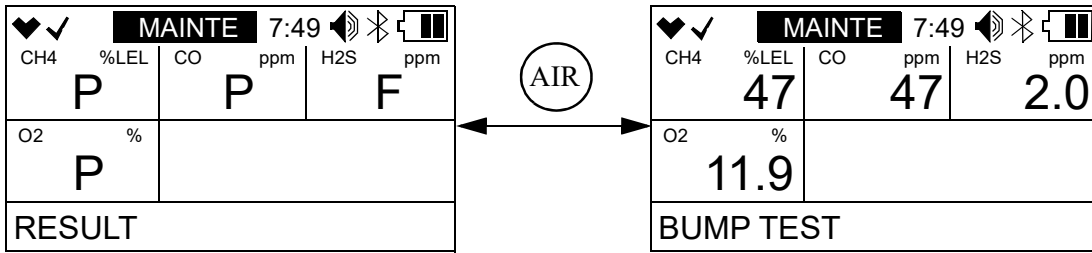

- b. To return to User Mode, press and release POWER MODE.
- c. If any channel failed the bump test, the LEDs will flash and the buzzer will sound a double pulsing tone until you press and release POWER MODE. See “Troubleshooting” on page 92.
- d. Turn the regulator knob clockwise to close the regulator.
- e. Continue to Step 15.

14 . When the **BUMP SETTING\BUMP PARAMETER\AUTO CAL** User Mode menu item is set to **ON**:

If all channels pass the bump test:

- a. When the countdown is done, the results screen appears. You can scroll between the bump test results and the bump test gas readings with AIR.

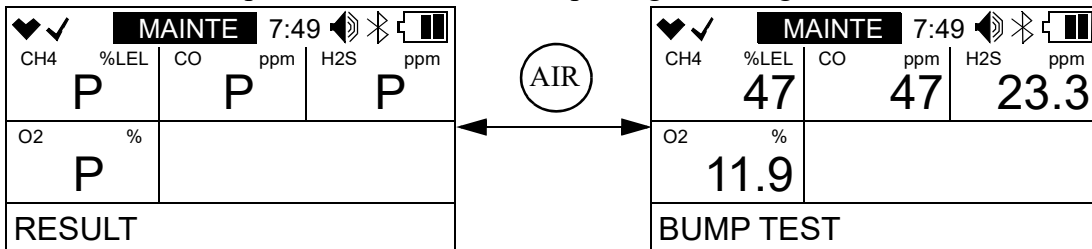

- b. To return to User Mode, press and release POWER MODE.
- c. Turn the regulator knob clockwise to close the regulator.
- d. Continue to Step 15.

If any channel fails the bump test:

- a. A calibration is immediately and automatically started after the initial countdown. Continue to apply the calibration gas. AUTO CAL will appear at the bottom of the screen and a new countdown will appear at the top.

The calibration time counted down during a calibration initiated because of a failed bump test is the difference between the **GAS TIME** and the **CAL TIME** values defined in the **BUMP SETTING\BUMP PARAMETER** menu item in User Mode.

♥✓		MAINTE		60	🔊	🔇	🔋
CH4	%LEL			H2S	ppm		
	0				0.0		
AUTO CAL				APPLY GAS			

- b. At the end of the calibration, the instrument displays the results from both the bump test and the calibration. Use AIR to scroll between the calibration/bump test results, the bump test gas readings, and the calibration gas readings.

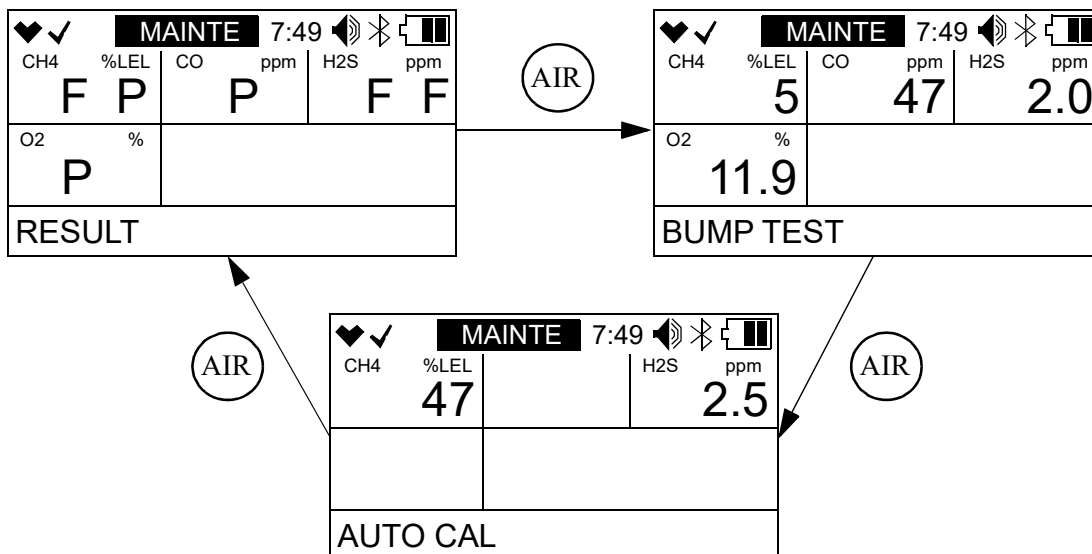

- c. To return to User Mode, press and release POWER MODE.
- d. If any channel failed the calibration, the LEDs will flash and the buzzer will sound a double pulsing tone until you press and release POWER MODE. See “Troubleshooting” on page 92.
- e. Turn the regulator knob clockwise to close the regulator.
- f. Continue to Step 15.

15. Unscrew the regulator from the calibration cylinder.
16. If necessary, repeat Step 1 through Step 15 for additional cylinders.
17. Remove the calibration cup from the GX-3R Pro.
18. Store the calibration kit in a safe and convenient place.

Performing a Calibration (GAS CAL)

Calibration Notes

- To fully calibrate the standard 4 (combustible gas, O₂, CO, H₂S) and super toxic sensors, you must do a fresh air adjustment (**AIR CAL**) and a span adjustment (**AUTO CAL**).
- To fully calibration the IR CO₂ sensor, you must do either a) a fresh air adjustment (**AIR CAL**) and a span adjustment (**AUTO CAL**) or b) a zero adjustment (**CO2 ZERO CAL**) and a span adjustment (**AUTO CAL**).
- The optimum frequency of calibration depends heavily on how the GX-3R Pro is used. Instruments used daily may need to be calibrated weekly or monthly, while instruments that are used only a few times a year may need to be calibrated before each use. Typical calibration frequencies range from monthly to quarterly.

Performing a Fresh Air Adjustment (AIR CAL)

1. Find a fresh air environment, an environment of normal oxygen content (20.9%) that is free of toxic and combustible gases.
2. While in User Mode, use AIR to place the cursor next to **GAS CAL**.

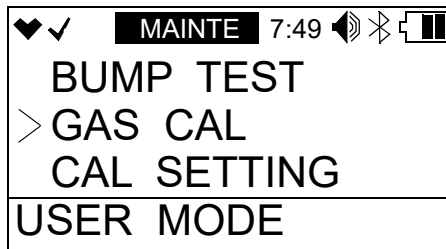

3. Press and release POWER MODE. The Gas Cal menu appears.
4. Use AIR to place the cursor next to **AIR CAL**.

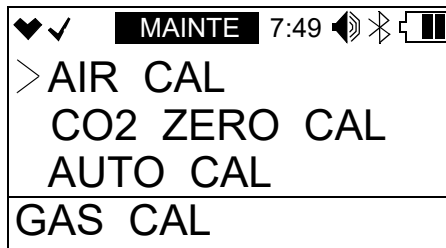

5. Press and release POWER MODE. The example below shows the standard 4 sensors (combustible gas, O₂, CO, H₂S).

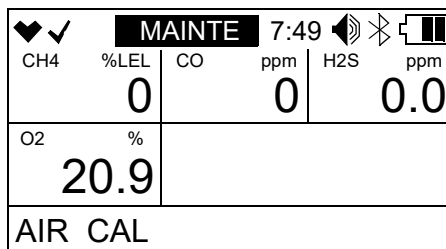

6. Press and hold AIR until the screen prompts you to release it.

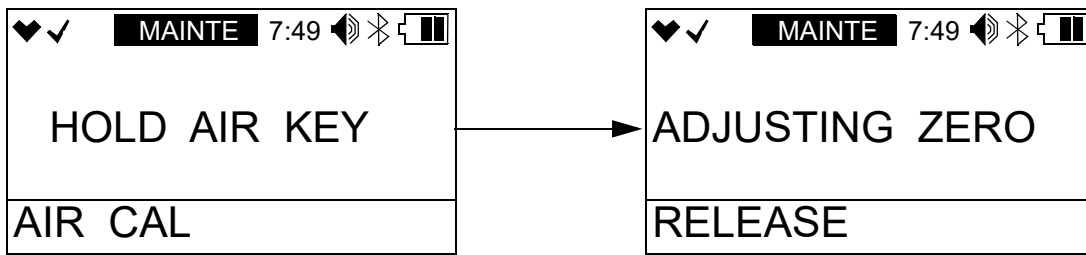

7. If the fresh air adjustment passes, the instrument returns to the Gas Cal menu.

8. If the fresh air adjustment fails, “FAIL AIR” displays. Press and release POWER MODE to acknowledge the failure. See “Troubleshooting” on page 92.

Performing a Zero Adjustment on the CO₂ Sensor (CO₂ ZERO CAL)

Performing a zero adjustment on the CO₂ sensor sets the sensor’s zero to a known concentration of CO₂ (0 ppm or 0%).

Preparing for a CO₂ ZERO CAL

To set the zero reading on the CO₂ sensor, you will need:

- 100% nitrogen (N₂) cylinder
 - 0.25 LPM fixed flow regulator
 - Non-absorbent tubing
 - Calibration cup
1. Confirm that the regulator knob is turned all the way clockwise. Screw the 0.25 LPM fixed flow regulator onto the calibration cylinder.
 2. Install the calibration cup onto the GX-3R Pro. Use the label and imprinting to make sure that the calibration cup gets installed in the correct orientation relative to the GX-3R Pro. Be sure the calibration cup is pushed on all the way.

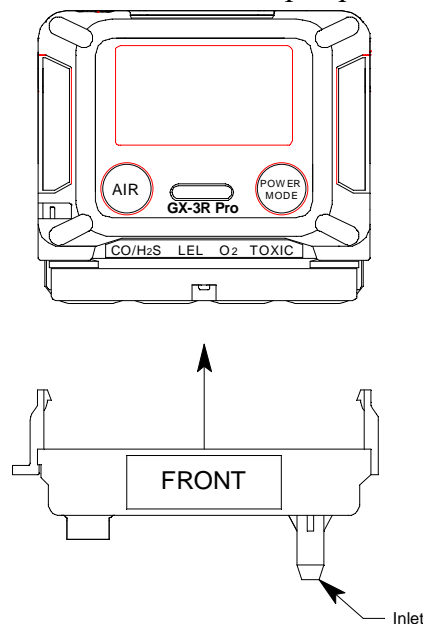
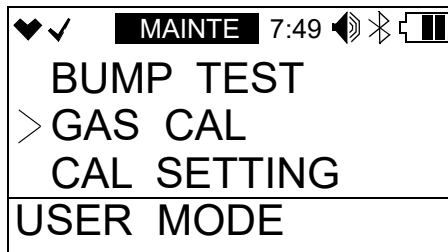

Figure 6: Calibration Cup Installation

3. Use the tubing to connect the regulator to the inlet of the calibration cup.

Performing a CO₂ ZERO CAL

1. While in User Mode, use AIR to place the cursor next to **GAS CAL**.



2. Press and release POWER MODE. The Gas Cal menu appears.

3. Use AIR to place the cursor next to **CO₂ ZERO CAL**.

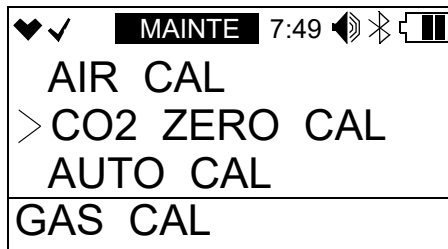

4. Press and release POWER MODE.

5. The CO₂ gas reading will flash and the bottom of the screen will indicate “CO₂ ZERO CAL” and “APPLY GAS”.

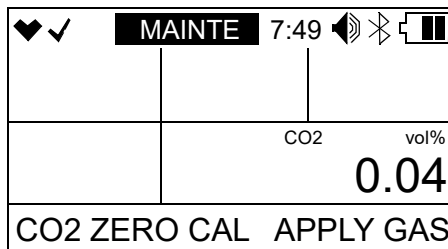

6. Turn the regulator knob counterclockwise to open the regulator.

7. Allow the gas to flow for 2 minutes.

8. Press and release POWER MODE.

9. Turn the regulator knob clockwise to close the regulator.

10. If the zero adjustment passed the screen says “PASS” and the instrument returns to the Gas Cal menu.

- 11 . If the zero adjustment failed:
 - a. “FAIL” will replace the gas reading.

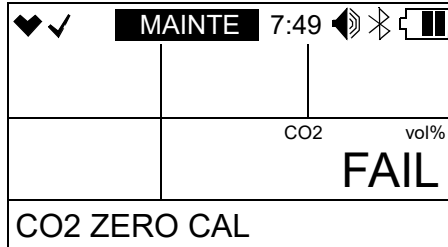

- b. The LEDs will flash and the buzzer will sound a double pulsing tone.
 - c. Press and release POWER MODE to clear the failure. The instrument returns to the **GAS CAL** menu.
 - d. See “Troubleshooting” on page 92.
- 12 . Unscrew the regulator from the calibration cylinder.
- 13 . Remove the calibration cup from the GX-3R Pro.
- 14 . Store the calibration kit in a safe and convenient place.
- 15 . Use AIR to place the cursor next to **ESCAPE**.
- 16 . Press and release POWER MODE. The instrument will return to User Mode.

Performing a Span Adjustment in AUTO CAL

Preparing for a Span Adjustment

To perform a span adjustment on the GX-3R Pro, you will need:

- Known concentrations of the gases being detected. The combustible and toxic gas samples should have concentrations between 10 and 50% of the full scale value. For example, if you are calibrating the combustible gas channel, your calibration cylinder should have a combustible gas concentration between 10% LEL and 50% LEL. An oxygen-free source, such as 100% nitrogen is recommended for setting the oxygen zero but a concentration of up to 19.5% is acceptable.

CAUTION: *Although the GX-3R Pro can be calibrated with an oxygen concentration of up to 19.5%, RKI Instruments, Inc. recommends that a multi-gas cylinder have an oxygen concentration in the range of 10% - 16% oxygen.*

- 0.25 LPM fixed flow regulator
 - Non-absorbent tubing
 - Calibration cup
- 1 . Confirm that the GX-3R Pro’s calibration gas values match the concentrations listed on the calibration gas cylinder(s) as described on pg.63.
 - 2 . Confirm that your cylinder selections are appropriate as described on pg.65.
 - 3 . Confirm that the regulator knob is turned all the way clockwise. Screw the 0.25 LPM fixed flow regulator onto the calibration cylinder.

4. Install the calibration cup onto the GX-3R Pro. Use the label and imprinting to make sure that the calibration cup gets installed in the correct orientation relative to the GX-3R Pro. Be sure the calibration cup is pushed on all the way.

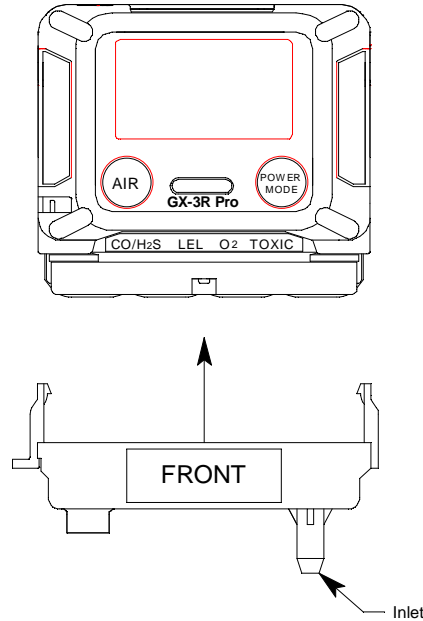
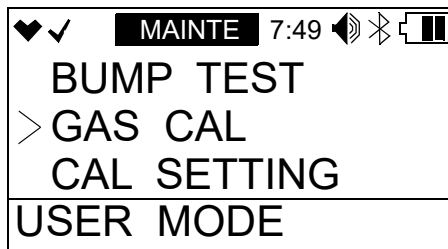

Figure 7: Calibration Cup Installation

5. Use the tubing to connect the regulator to the inlet of the calibration cup.

Performing a Span Adjustment

1. While in User Mode, use AIR to place the cursor next to **GAS CAL**.



2. Press and release POWER MODE. The Gas Cal menu appears.
3. Use AIR to place the cursor next to **AUTO CAL**.



4. Press and release POWER MODE. The display will show the gases assigned to Cylinder A and the assigned calibration values (see pg.63 if the calibration values do not match the calibration gas cylinder’s concentrations).

♥✓		MAINT		7:49		🔊		📶		🔋	
CH4	%LEL	CO	ppm	H2S	ppm						
	50		50		25.0						
O2	%										
	12.0										
AUTO CAL		CYLINDER A									

5. If necessary, use AIR to scroll to the Auto Cal screen for the gas(es) you want to calibrate. As shipped from the factory, the standard 4 gases (combustible gas, O₂, CO, and H₂S) are assigned to Cylinder A. Hydrogen-compensated CO and other toxic sensors are assigned to Cylinder D or Cylinder E.
6. Press and release POWER MODE.
7. The gas readings will flash and the bottom of the screen will indicate “AUTO CAL” and “APPLY GAS”.

♥✓		MAINT		30		🔊		📶		🔋	
CH4	%LEL	CO	ppm	H2S	ppm						
	0		0		0.0						
O2	%										
	20.9										
AUTO CAL		APPLY GAS									

8. Turn the regulator knob counterclockwise to open the regulator.
9. Allow the gas to flow for 2 minutes.
10. Press and release POWER MODE.
11. Turn the regulator knob clockwise to close the regulator.
12. If the calibration passed:
 - a. The screen says “PASS”, shows the current gas readings, and the instrument returns to the Gas Cal menu.
 - b. If **DISP MAX SPAN** is set to **ON** in Gas Select Mode (see pg.150), then before returning to the Gas Cal menu, the instrument will indicate the maximum possible adjustment it could have made to the response reading. So if the combustible gas channel was calibrated with 50% LEL gas and the maximum indicated span is 95% LEL, this means that there was enough adjustment left on that channel to set the reading to 95% LEL when the detector was exposed to 50% LEL gas. If the maximum span value is close to the calibration gas value, for example if it is 53% LEL when exposed to 50% LEL gas, the sensor should be replaced soon. The upper limit on the maximum adjustment indicated for all channels except for oxygen is either twice the calibration value or full scale, whichever is lower. The upper limit on the maximum adjustment indicated for the oxygen channel is 25.0% volume.

13 . If the calibration failed:

- a. “FAIL” will replace the gas reading for the failed sensors.

♥✓	MAINTE	30	🔊	📶	🔋
CH4	%LEL	CO	ppm	H2S	ppm
FAIL		50		25.0	
O2	%				
12.0					
AUTO CAL					

- b. The LEDs will flash and the buzzer will sound a double pulsing tone.
 - c. Press and release POWER MODE to clear the failure. The instrument returns to the **GAS CAL** menu.
 - d. See “Troubleshooting” on page 92.
- 14 . Unscrew the regulator from the calibration cylinder.
- 15 . If necessary, repeat Step 1 though Step 14 for additional cylinders.
- 16 . Remove the calibration cup from the GX-3R Pro.
- 17 . Store the calibration kit in a safe and convenient place.
- 18 . Use AIR to place the cursor next to **ESCAPE**.
- 19 . Press and release POWER MODE. The instrument will return to User Mode.

Setting the Calibration Values in SETTING CAL--P

- 1 . While in User Mode, use AIR to place the cursor next to **GAS CAL**.

♥✓	MAINTE	7:49	🔊	📶	🔋
BUMP TEST					
> GAS CAL					
CAL SETTING					
USER MODE					

- 2 . Press and release POWER MODE. The Gas Cal menu appears.
- 3 . Use AIR to place the cursor next to **AUTO CAL**.

♥✓	MAINTE	7:49	🔊	📶	🔋
CO2 ZERO CAL					
> AUTO CAL					
ESCAPE					
GAS CAL					

- 4 . Press and release POWER MODE. The Auto Cal screen for gases assigned to Cylinder A will display.

5. Use AIR to scroll to **SETTING CAL--P**.



6. Press and release POWER MODE. The combustible gas channel will display.

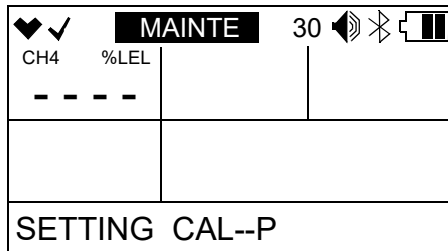

7. Use AIR to scroll to the channel whose calibration gas value you want to change.

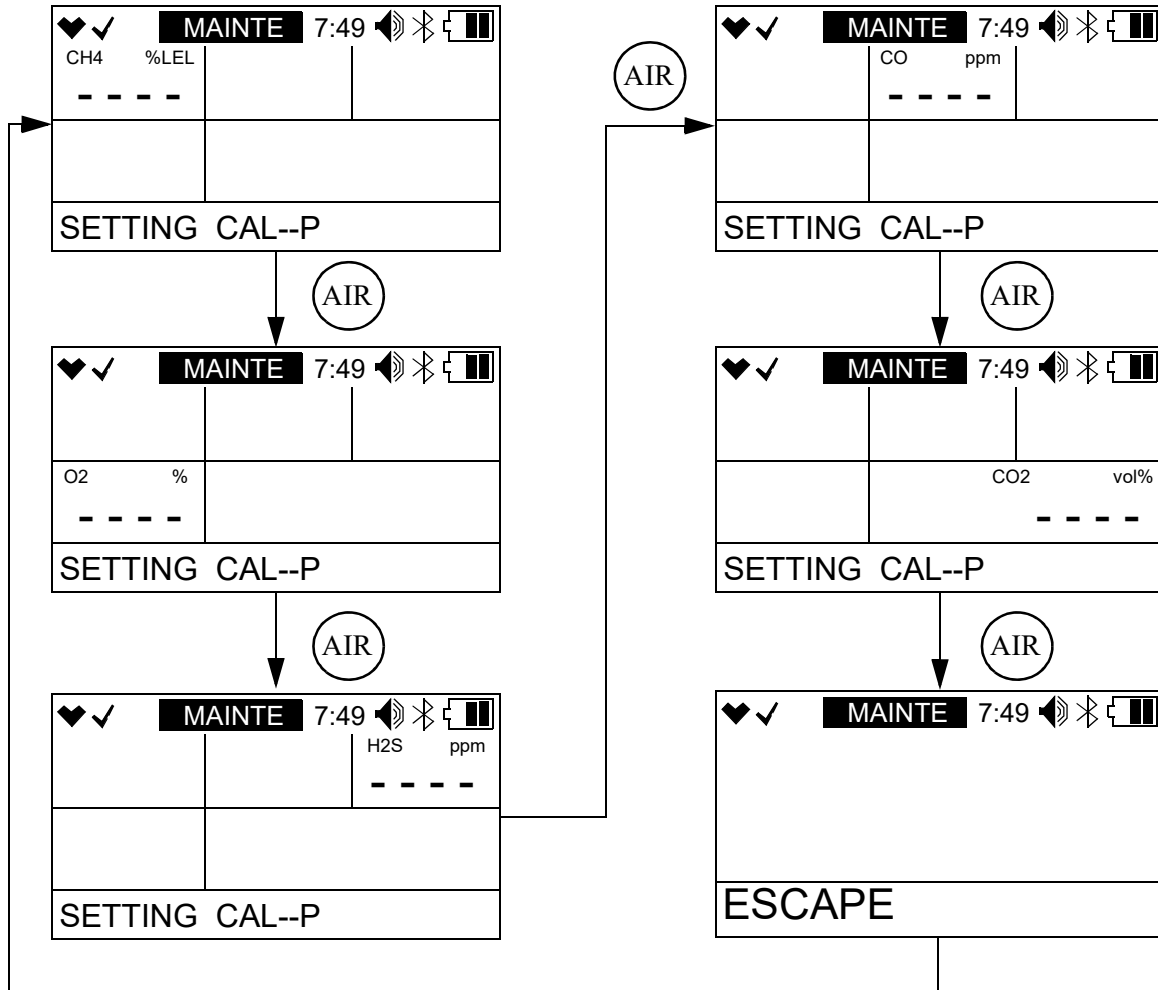

- 8 . Press and release POWER MODE. The calibration gas value will begin to flash. In the example below, the combustible gas channel is selected.

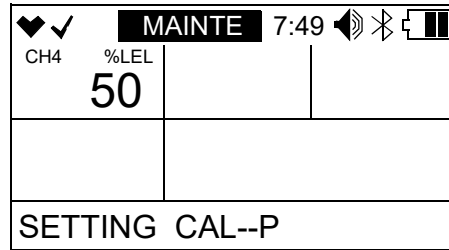

- 9 . Use AIR to adjust the calibration gas value. The calibration gas value in the instrument must match the value listed on the calibration gas cylinder you are using for that channel.

NOTE: If you are using an RKI 4-gas cylinder, be sure to set the O₂ channel to 12%, not 0%.

- 10 . Press and release POWER MODE to save the change. The calibration gas value stops flashing and the unit returns to the channel selection screen.
- 11 . Repeat Step 7 through Step 10 for any other channels that need to be changed.
- 12 . Use AIR to place the cursor next to **ESCAPE**.
- 13 . Press and release POWER MODE. The instrument will return to the **SETTING CAL--P** menu item in the Auto Cal Menu.
- 14 . Use AIR to place the cursor next to **ESCAPE**.
- 15 . Press and release POWER MODE. The instrument will return to the **GAS CAL** menu.
- 16 . Use AIR to place the cursor next to **ESCAPE**.
- 17 . Press and release POWER MODE. The instrument will return to User Mode.

Making Cylinder Selections in CYL SETTING

The **CYL SETTING** menu item allows you to group gases together for calibration. As shipped from the factory, the standard 4 gases (combustible gas, O₂, H₂S, CO) are assigned to Cylinder A which means all 4 gases are calibrated at once. As shipped from the factory, the hydrogen-compensated CO and toxic gases are assigned to Cylinder D or Cylinder E. There are 5 cylinder assignments available: A, B, C, D, and E. If you want to calibrate each gas separately, you need to assign each gas to a different cylinder (ie. Cylinder A: combustible gas, Cylinder B: O₂, Cylinder C: H₂S, Cylinder D: CO, Cylinder E: CO₂).

- 1 . While in User Mode, use AIR to place the cursor next to **GAS CAL**.

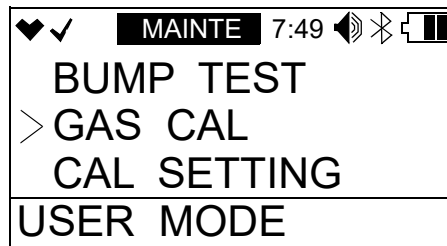

2. Press and release POWER MODE. The Gas Cal menu appears.
3. Use AIR to place the cursor next to **AUTO CAL**.

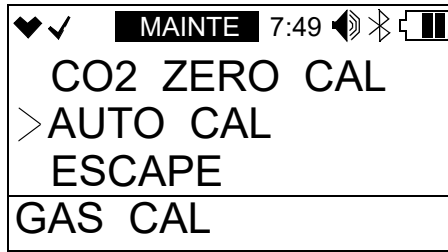

4. Press and release POWER MODE. The Auto Cal screen for gases assigned to Cylinder A will display.
5. Use AIR to scroll to **CYL SETTING**.



6. Press and release POWER MODE. The combustible gas channel will display.

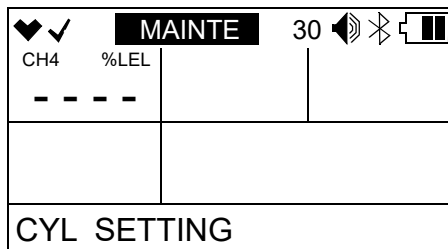

7. Use AIR to scroll to the channel whose cylinder assignment you want to change.

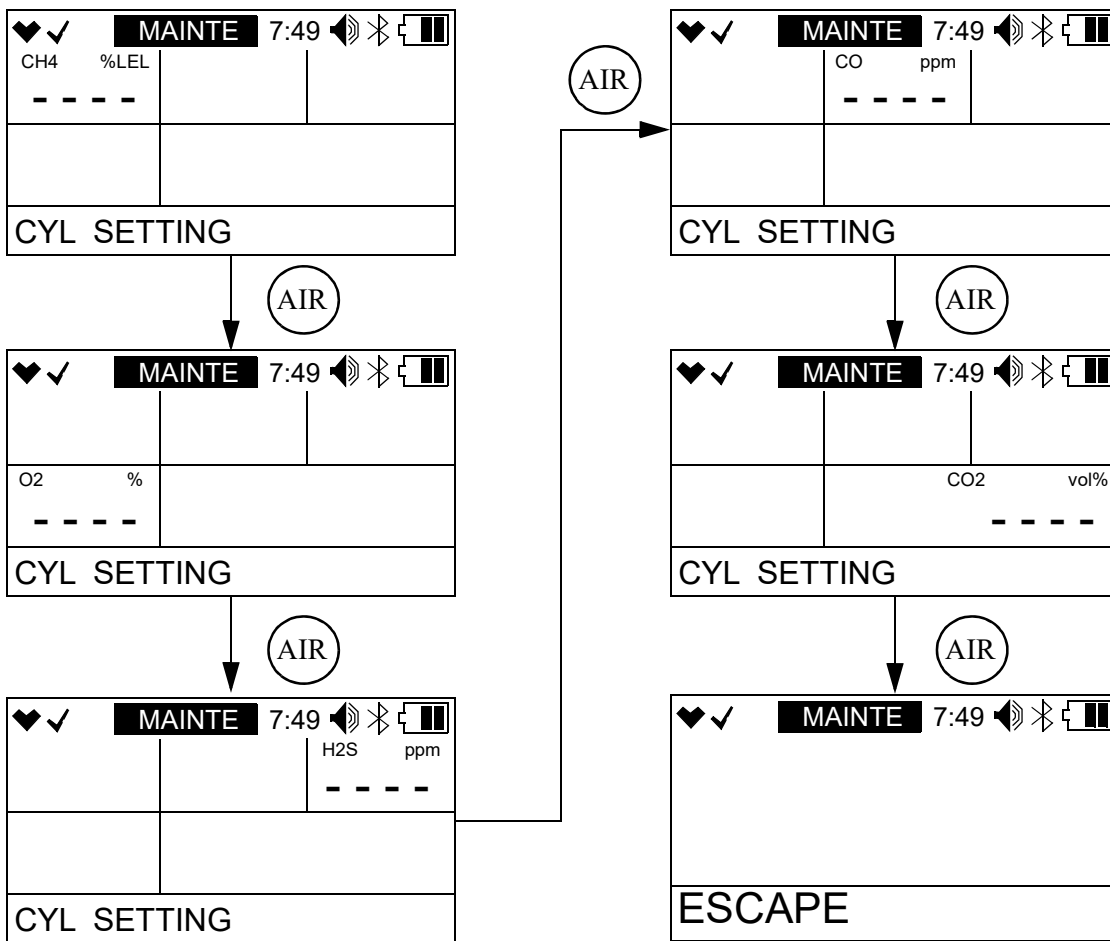

8. Press and release POWER MODE. The current setting will flash. In the example below, the combustible gas channel is selected.

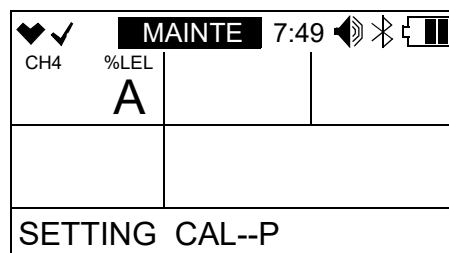

9. Use AIR to change the cylinder assignment. The choices are A, B, C, D, and E.
10. Press and release POWER MODE to save the change. The cylinder assignment stops flashing and the unit returns to the channel selection screen.
11. Repeat Step 7 through Step 10 for any other channels that need to be changed.
12. Use AIR to place the cursor next to **ESCAPE**.
13. Press and release POWER MODE. The instrument will return to the **CYL SETTING** menu item in the Auto Cal Menu.
14. Use AIR to place the cursor next to **ESCAPE**.
15. Press and release POWER MODE to return to the **GAS CAL** menu.

16 . Use AIR to place the cursor next to **ESCAPE**.

17 . Press and release POWER MODE. The instrument will return to User Mode.

Setting Calibration Parameters (CAL SETTING)

The **CAL SETTING** menu item has a sub menu with 5 menu items: **CAL REMINDER**, **CAL INTERVAL**, **CAL EXPIRED**, **CAL CHECK GAS**, and **ESCAPE**.

1 . While in User Mode, use AIR to place the cursor next to **CAL SETTING**.



2 . Press and release POWER MODE. The **CAL SETTING** menu appears.

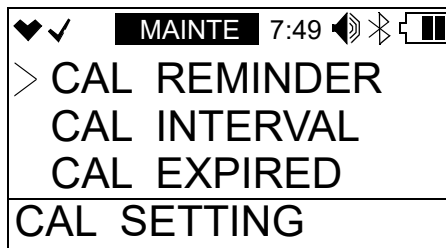

CAL REMINDER

ON (factory setting): The GX-3R Pro will give an indication at start up if it is due for calibration. The type of indication will depend on the **CAL EXPIRED** setting (see pg.69).

OFF: The GX-3R Pro will not give an indication at start up if it is due for calibration.

1 . While in the **CAL SETTING** menu, use AIR to place the cursor next to **CAL REMINDER**.

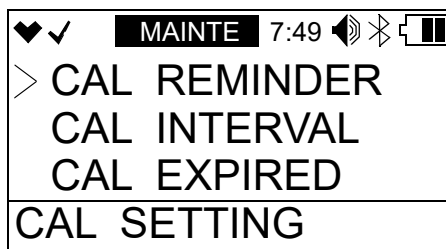

2 . Press and release POWER MODE. The current setting flashes.

3 . Use AIR to display the desired setting.

4 . Press and release POWER MODE to save the setting and return to the **CAL SETTING** menu.

CAL INTERVAL

This setting defines the amount of time between calibrations. The time can be set in 1 day increments. The minimum setting is 1 day and the maximum setting is 1000 days. The factory setting is 90 days.

1. While in the **CAL SETTING** menu, use AIR to place the cursor next to **CAL INTERVAL**.

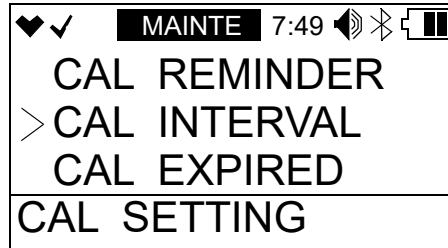

2. Press and release POWER MODE. The current setting flashes.
3. Use AIR to display the desired setting.
4. Press and release POWER MODE to save the setting and return to the **CAL SETTING** menu.

CAL EXPIRED

This item defines what indication is given during start up when calibration is due and **CAL REMINDER** is set to **ON**.

CONFIRM TO USE (factory setting): The GX-3R Pro will give an indication at start up if calibration is past due and will require the user to decide whether to perform a calibration or continue and use the GX-3R Pro without calibrating. Press and release AIR to continue without calibrating or POWER MODE to perform a calibration.

CANNOT USE: If the unit is due for calibration, the GX-3R Pro will give an indication at start up that calibration is past due and will prompt you to press and release POWER MODE to enter User Mode and perform a calibration. Pressing AIR will have no effect. A successful calibration must be performed in order to use the instrument.

NO EFFECT: The GX-3R Pro will give an indication at startup that calibration is past due. If desired, POWER MODE can be pressed to perform a calibration but it is not necessary to acknowledge the calibration due indication. The warm-up sequence will continue on its own.

1. While in the **CAL SETTING** menu, use AIR to place the cursor next to **CAL EXPIRED**.

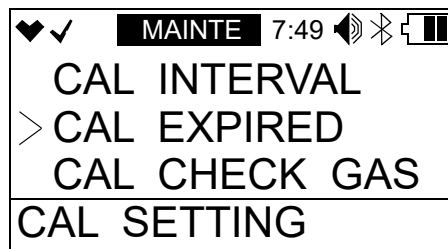

2. Press and release POWER MODE. The current setting flashes.
3. Use AIR to display the desired setting.

- Press and release POWER MODE to save the setting and return to the **CAL SETTING** menu.

CAL CHECK GAS

ALL GAS (factory setting): Calibration dates for all gases are used to determine if calibration is due.

4 GAS: Calibration dates for only the standard 4 gases (combustible gas/O₂/H₂S/CO) are used to determine if calibration is due.

- While in the **CAL SETTING** menu, use AIR to place the cursor next to **CAL CHECK GAS**.



- Press and release POWER MODE. The current setting flashes.
- Use AIR to display the desired setting.
- Press and release POWER MODE to save the setting and return to the **CAL SETTING** menu.

ESCAPE

- While in the **CAL SETTING** menu, use AIR to place the cursor next to **ESCAPE**.
- Press and release POWER MODE. The instrument will return to User Mode.

Setting Bump Test Parameters (BUMP SETTING)

The **BUMP SETTING** menu item has a sub menu with 6 menu items: **BUMP PARAMETERS**, **BUMP REMINDER**, **BUMP INTERVAL**, **BUMP EXPIRED**, **BUMP CHECK GAS**, and **ESCAPE**.

- While in User Mode, use AIR to place the cursor next to **BUMP SETTING**.

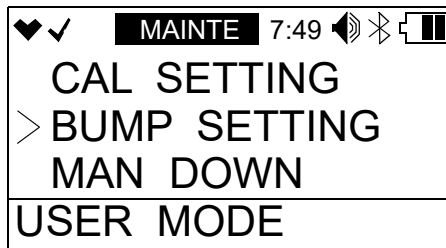

- Press and release POWER MODE. The **BUMP SETTING** menu appears.

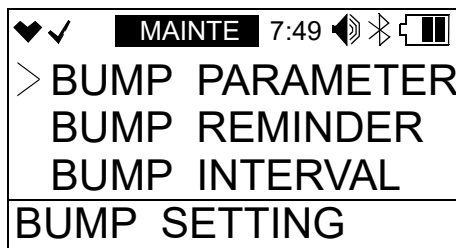

BUMP PARAMETER

The **BUMP PARAMETER** menu item has its own sub-menu with 5 menu items: **GAS TIME**, **TOLERANCE**, **CAL TIME**, **AUTO CAL**, and **ESCAPE**.

1. While in the **BUMP SETTING** menu, use AIR to place the cursor next to **BUMP PARAMETER**.

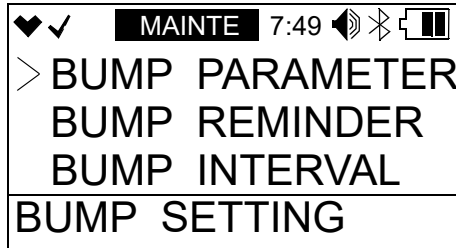

2. Press and release POWER MODE. The **BUMP PARAMETER** menu appears.

GAS TIME

The **GAS TIME** is the amount of time that the instrument is exposed to gas during a bump test. The available choices are **30** seconds (factory setting), **45** seconds, **60** seconds, and **90** seconds.

1. While in the **BUMP PARAMETER** menu, use AIR to place the cursor next to **GAS TIME**.

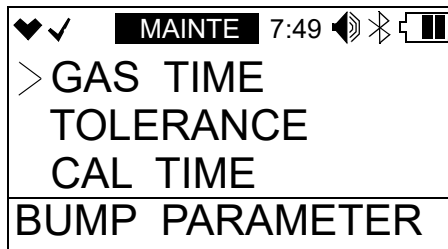

2. Press and release POWER MODE. The current setting flashes.
3. Use AIR to display the desired setting.
4. Press and release POWER MODE to save the setting and return to the **BUMP PARAMETER** menu.

TOLERANCE

TOLERANCE is the bump test tolerance value and is represented as a percentage of the calibration gas concentration. It is the percentage that the bump test reading can differ from the actual gas concentration. If the bump test reading differs more, the bump test will fail. The available values are **10%**, **20%**, **30%**, **40%**, and **50%** (factory setting).

1. While in the **BUMP PARAMETER** menu, use AIR to place the cursor next to **TOLERANCE**.

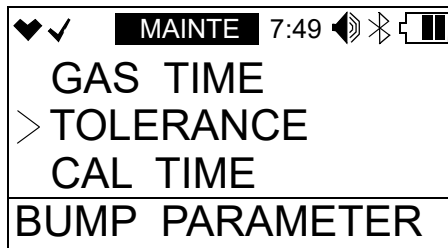

2. Press and release POWER MODE. The current setting flashes.
3. Use AIR to display the desired setting.
4. Press and release POWER MODE to save the setting and return to the **BUMP PARAMETER** menu.

CAL TIME

The **CAL TIME** is the total time the instrument is exposed to calibration gas when a bump test fails if **AUTO CAL** is set to **ON**. The bump test time is deducted from the calibration time. For example, if the **CAL TIME** is set to 90 seconds and the **GAS TIME** is set to 30 seconds, if the bump test fails, the GX-3R Pro will only be exposed to gas for an additional 60 seconds. The available values are **90** seconds (factory setting), and **120** seconds.

1. While in the **BUMP PARAMETER** menu, use AIR to place the cursor next to **CAL TIME**.



2. Press and release POWER MODE. The current setting flashes.
3. Use AIR to display the desired setting.
4. Press and release POWER MODE to save the setting and return to the **BUMP PARAMETER** menu.

AUTO CAL

ON (factory setting): If a bump test fails, the unit will automatically begin a calibration.

OFF: If a bump test fails, the unit will not automatically begin a calibration.

1. While in the **BUMP PARAMETER** menu, use AIR to place the cursor next to **AUTO CAL**.



2. Press and release POWER MODE. The current setting flashes.
3. Use AIR to display the desired setting.
4. Press and release POWER MODE to save the setting and return to the **BUMP PARAMETER** menu.

ESCAPE

1. While in the **BUMP PARAMETER** menu, use AIR to place the cursor next to **ESCAPE**.



2. Press and release POWER MODE. The instrument will return to the **BUMP PARAMETER** menu.

BUMP REMINDER

ON: The GX-3R Pro will give an indication at start up if it is due for bump testing. The type of indication will depend on the **BUMP EXPIRED** setting (see pg.74).

OFF (factory setting): The GX-3R Pro will not give an indication at start up if it is due for bump testing.

1. While in the **BUMP SETTING** menu, use AIR to place the cursor next to **BUMP REMINDER**.

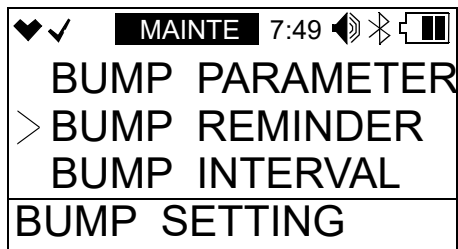

2. Press and release POWER MODE. The current setting flashes.
3. Use AIR to display the desired setting.
4. Press and release POWER MODE to save the setting and return to the **BUMP SETTING** menu.

BUMP INTERVAL

This setting defines the amount of time between bump tests. The time can be set in 1 day increments. The minimum setting is **0** days and the maximum setting is **30** days. The factory setting is **30** days.

1. While in the **BUMP SETTING** menu, use AIR to place the cursor next to **BUMP INTERVAL**.

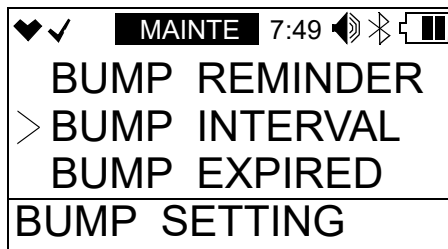

2. Press and release POWER MODE. The current setting flashes.
3. Use AIR to display the desired setting.

4. Press and release **POWER MODE** to save the setting and return to the **BUMP SETTING** menu.

BUMP EXPIRED

This item defines what indication is given during start up when a bump test is due and **BUMP REMINDER** is set to **ON**.

CONFIRM TO USE (factory setting): The GX-3R Pro will give an indication at start up if a bump test is past due and will require the user to decide whether to perform a bump test or continue and use the GX-3R Pro without bump testing. Press and release **AIR** to continue without bump testing or **POWER MODE** to perform a bump test.

CANNOT USE: If the unit is due for bump testing, the GX-3R Pro will give an indication at start up that a bump test is past due and will prompt you to press and release **POWER MODE** to enter User Mode and perform a bump test. Pressing **AIR** will have no effect. A successful bump test must be performed in order to use the instrument.

NO EFFECT: The GX-3R Pro will give an indication at startup that a bump test is past due. If desired, **POWER MODE** can be pressed to perform a bump test but it is not necessary to acknowledge the bump test due indication. The warm-up sequence will continue on its own.

1. While in the **BUMP SETTING** menu, use **AIR** to place the cursor next to **BUMP EXPIRED**.

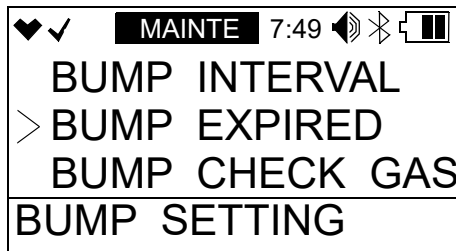

2. Press and release **POWER MODE**. The current setting flashes.
3. Use **AIR** to display the desired setting.
4. Press and release **POWER MODE** to save the setting and return to the **BUMP SETTING** menu.

BUMP CHECK GAS

ALL GAS (factory setting): Bump test dates for all gases are used to determine if bump test is due.

4 GAS: Bump test dates for only the standard 4 gases (combustible gas/O₂/H₂S/CO) are used to determine if bump test is due.

1. While in the **BUMP SETTING** menu, use **AIR** to place the cursor next to **BUMP CHECK GAS**.



2. Press and release **POWER MODE**. The current setting flashes.
3. Use **AIR** to display the desired setting.
4. Press and release **POWER MODE** to save the setting and return to the **BUMP SETTING** menu.

ESCAPE

1. While in the **BUMP SETTING** menu, use **AIR** to place the cursor next to **ESCAPE**.



2. Press and release **POWER MODE**. The instrument will return to User Mode.

Adjusting Man Down and Panic Settings (MAN DOWN)

The **MAN DOWN** menu item in User Mode has a sub menu with 4 menu items: **MAN DOWN**, **PANIC**, **MAN DOWN TIME**, and **ESCAPE**.

1. While in User Mode, use **AIR** to place the cursor next to **MAN DOWN**.

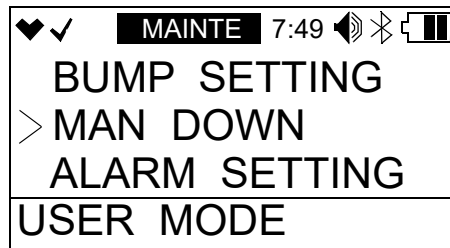

2. Press and release **POWER MODE**. The **MAN DOWN** menu appears.



Turning Man Down On/Off

ON: The Man Down alarm can be triggered if the instrument detects no motion for the period of time defined in **WARNING 1 TIME**, **WARNING 2 TIME**, and **ALARM TIME** below.

OFF (factory setting): The Man Down alarm cannot be triggered.

1. While in the **MAN DOWN** menu, use AIR to place the cursor next to **MAN DOWN**.



2. Press and release POWER MODE. The current setting flashes.
3. Use AIR to display the desired setting.
4. Press and release POWER MODE to save the setting and return to the **MAN DOWN** menu.

Turning Panic On/Off

ON (factory setting): A Panic Alarm can be initiated by firmly tapping the instrument twice in a row.

OFF: A Panic Alarm cannot be initiated.

1. While in the **MAN DOWN** menu, use AIR to place the cursor next to **PANIC**.



2. Press and release POWER MODE. The current setting flashes.
3. Use AIR to display the desired setting.
4. Press and release POWER MODE to save the setting and return to the **MAN DOWN** menu.

Setting the Man Down Warning/Alarm Times (MAN DOWN TIME)

The Man Down Warning/Alarm times are the amount of time that has to pass between a Man Down detection and each warning/alarm. It can be set in 1 second increments from 10 - 120 seconds. The factory setting is 60 seconds. When setting the Man Down Warning/Alarm times, keep in mind that **ALARM TIME** ≥ **WARNING 2 TIME** ≥ **WARNING 1 TIME**.

Table 15: Man Down Warning Alarm Time Factory Settings

Warning/Alarm	Factory Setting
WARNING 1 TIME	60 seconds
WARNING 2 TIME	75 seconds
ALARM TIME	90 seconds

1. While in the **MAN DOWN** menu, use **AIR** to place the cursor next to **MAN DOWN TIME**.



2. Press and release **POWER MODE**. The current setting for the **WARNING 1 TIME** will flash.

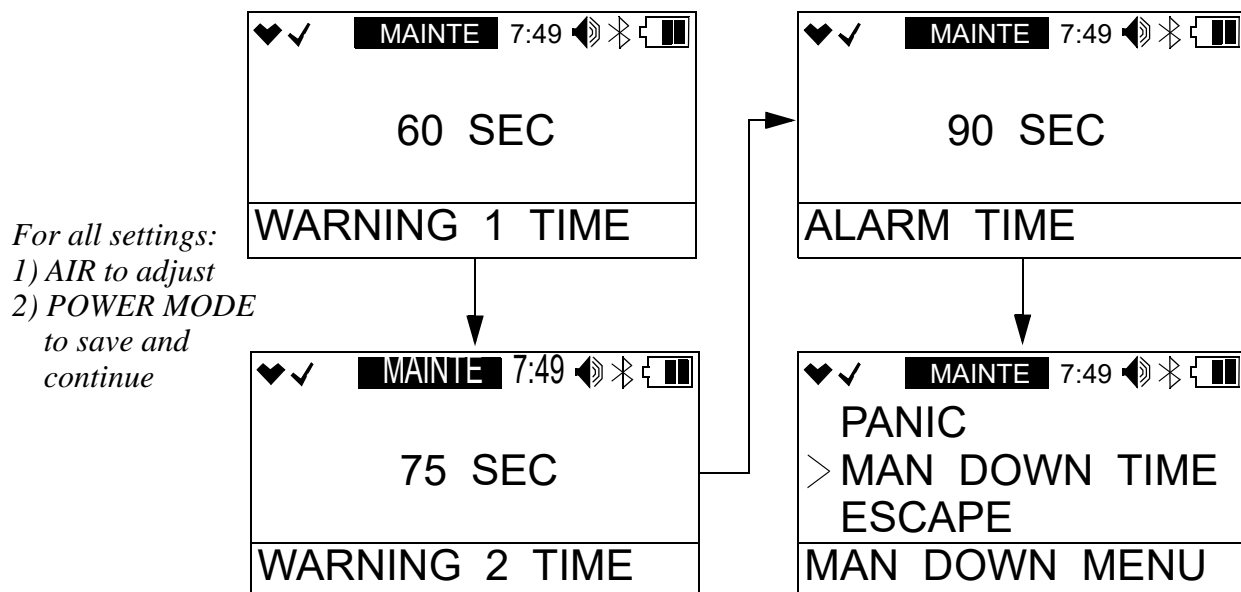

3. Use **AIR** to adjust the **WARNING 1 TIME**.
4. Press and release **POWER MODE** to save the setting.
5. Repeat Step 3 and Step 4 for the **WARNING 2 TIME** and **ALARM TIME** settings.
6. The instrument will return to the **MAN DOWN** menu.

ESCAPE

1. While in the **MAN DOWN** menu, press **AIR** to scroll to **ESCAPE**.
2. Press and release **POWER MODE**. The instrument will return to User Mode.

Alarm Settings (ALARM SETTING)

In the Alarm Settings menu item, you can change the alarm points and default the alarm points back to their factory settings.

1. While in User Mode, use **AIR** to place the cursor next to **ALARM SETTING**.



2. Press and release **POWER MODE**. The first channel is displayed.

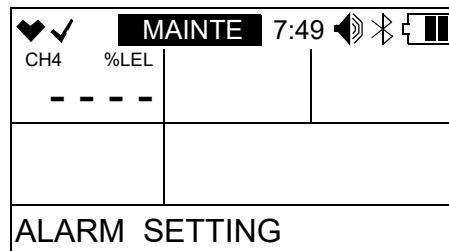

Setting the Alarm Points

1. While in the **ALARM SETTING** menu, press AIR to scroll through to the instrument channel whose alarm points you want to change.

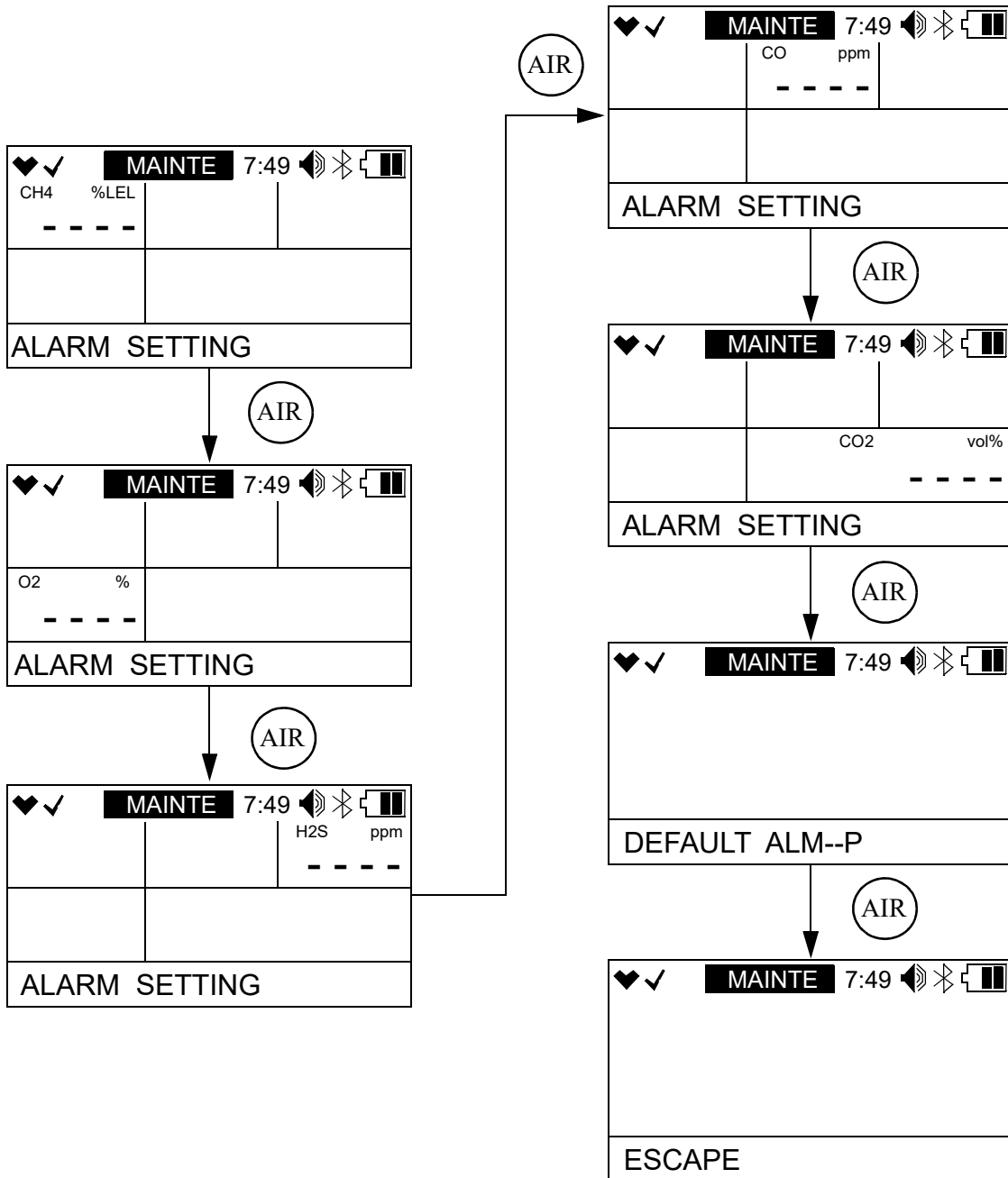

2. Press and release POWER MODE.

- The Warning setpoint for the channel will display and it will be flashing. In the example below, the CO channel is selected.

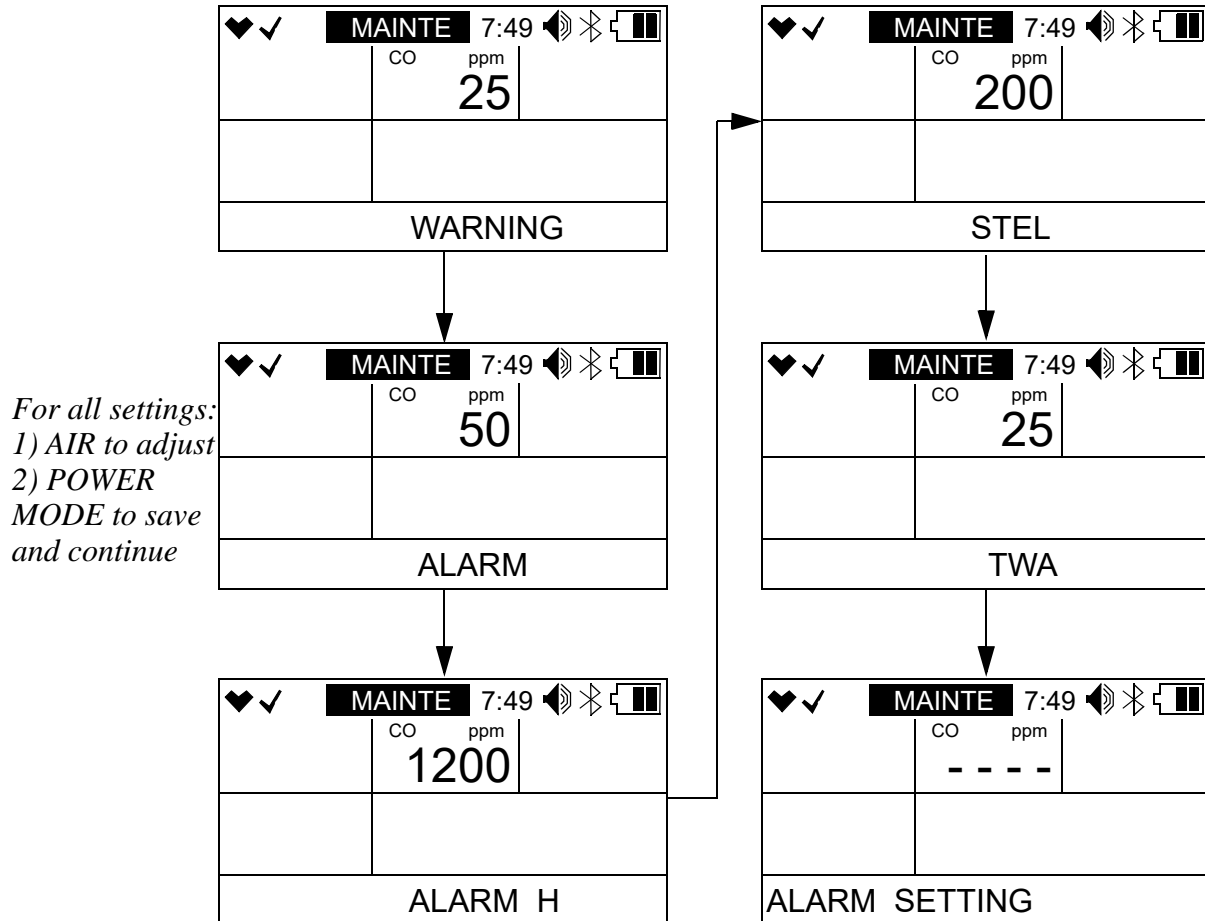

- Use AIR to adjust the Warning setpoint.
- Press and release POWER MODE to save the setting.
- Repeat Step 4 and Step 5 for the Alarm, Alarm H, STEL (CO, H₂S, CO₂, and super toxic only) and TWA (CO, H₂S, CO₂, and super toxic only) settings.
- The instrument will return to the **ALARM SETTING** menu.
- Repeat Step 1 - Step 7 to change the alarm points for other channels.

Defaulting the Alarm Points

Defaulting the alarm points defaults them back to factory settings as outlined in Table 1 on page 8 or to the settings saved in the **SET DEF ALM-P** menu item in Gas Select Mode if you have performed a **SET DEF ALM-P** operation.

1. While in the **ALARM SETTING** menu, press AIR to scroll to **DEFAULT ALM--P**.

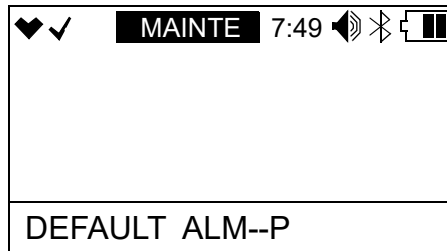

2. Press POWER MODE to enter the **DEFAULT ALM--P** menu item.
3. Press POWER MODE to perform an alarm default. Press AIR to return to the **DEFAULT ALM--P** menu item.
4. The instrument will ask if you're sure you want to default the alarm points. Press POWER MODE to default the alarm points. Press AIR to return to the **ALARM SETTING** menu.

ESCAPE

1. While in the **ALARM SETTING** menu, press AIR to scroll to **ESCAPE**.
2. Press and release POWER MODE. The instrument will return to User Mode.

Updating the Lunch Break Setting (LUNCH BREAK)

OFF (factory setting): The GX-3R Pro automatically starts new TWA and PEAK reading collection and resets the time in operation at startup.

ON: The Lunch Break Screen displays during startup. From this screen, you can choose to continue accumulating TWA and PEAK readings and the time in operation from the last time the GX-3R Pro was used or start collecting new readings and reset the time in operation.

1. While in User Mode, use AIR to place the cursor next to **LUNCH BREAK**.



2. Press and release POWER MODE. The current setting flashes.
3. Use AIR to display the desired setting.
4. Press and release POWER MODE to save the setting and return to User Mode.

Setting the Confirmation Beep and Non-Compliance Indicator (CONFIRMATION)

The **CONFIRMATION** menu item has a sub menu with 3 menu items: **BEEP SELECT**, **BEEP INTERVAL**, and **ESCAPE**.

1. While in User Mode, use **AIR** to place the cursor next to **CONFIRMATION**.

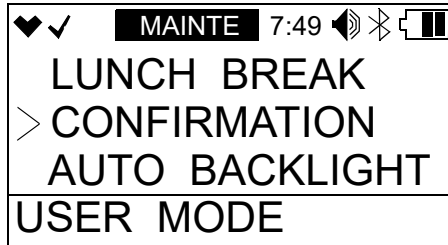

2. Press and release **POWER MODE** to enter the Confirmation Menu.



BEEP SELECT

BEEP SELECT defines what kind of confirmation or non-compliance indication you want to occur in Measuring Mode. The available choices are:

OFF (factory setting): The GX-3R Pro does not provide a confirmation alert or non-compliance indicator.

LED: The GX-3R Pro's LEDs double flash as often as defined by the **BEEP INTERVAL** parameter to verify that the instrument is operating.

BUZZER: The GX-3R Pro's buzzer double beeps as often as defined by the **BEEP INTERVAL** parameter to verify that the instrument is operating.

LED+BUZZER: The GX-3R Pro's LEDs double flash and the buzzer double beeps as often as defined by the **BEEP INTERVAL** parameter to verify that the instrument is operating.

BUMP/CAL: If a bump test or a calibration is due and if **BUMP EXPIRED** or **CAL EXPIRED** is set to **CONFIRM TO USE** or **NO EFFECT**, the GX-3R Pro's LEDs double flash as often as defined by the **BEEP INTERVAL** parameter to indicate a non-compliance. Once a bump test or calibration (depending on which is due) is done, the LEDs will stop flashing.

ALARM ALERT: If the instrument goes into any gas alarm, the LEDs double flash as often as defined by the **BEEP INTERVAL** parameter to indicate a non-compliance. Once a successful bump test or calibration is done, the LEDs will stop flashing.

NOTE: Depending on the **Need to get Bump Log** setting (only accessed via **SDM-3R** program), a data download may also be needed to clear the non-compliance.

BUMP/CAL/ALARM: The LEDs double flash to indicate a non-compliance if any of the following happens.

- a. **BUMP EXPIRED** is set to **CONFIRM TO USE** or **NO EFFECT** and a bump test is due (cleared by successful bump test).
- b. **CAL EXPIRED** is set to **CONFIRM TO USE** or **NO EFFECT** and a calibration is due (cleared by successful calibration).
- c. The instrument goes into any gas alarm (cleared by successful bump test or calibration).

NOTE: Depending on the **Need to get Bump Log** setting (only accessed via SDM-3R program), a data download may also be needed to clear the gas alarm non-compliance.

1. While in the **CONFIRMATION** menu, use AIR to place the cursor next to **BEEP SELECT**.

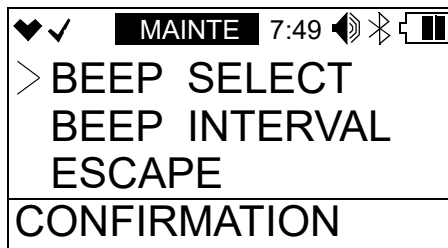

2. Press and release POWER MODE. The current setting flashes.
3. Use AIR to display the desired setting.
4. Press and release POWER MODE to save the setting and return to the Confirmation Menu.

BEEP INTERVAL

The **BEEP INTERVAL** parameter defines how often the confirmation alert or non-compliance indicator selected in **BEEP SELECT** occurs. This setting only applies if the **BEEP SELECT** parameter is set to something other than **OFF**. The available choices are **0.5** minutes and **1-99** minutes in 1 minute increments. The factory setting is **5** minutes.

1. While in the **CONFIRMATION** menu, use AIR to place the cursor next to **BEEP INTERVAL**.



2. Press and release POWER MODE. The current setting flashes.
3. Use AIR to display the desired setting.
4. Press and release POWER MODE to save the setting and return to the Confirmation Menu.

ESCAPE

1. While in the **CONFIRMATION** menu, use AIR to place the cursor next to **ESCAPE**.
2. Press and release POWER MODE. The instrument will return to User Mode.

Auto Backlight in Low Light (AUTO BACKLIGHT)

The GX-3R Pro has a luminescence sensor that allows the instrument to detect how bright an environment is.

ON (factory setting): The instrument's backlight automatically turns on in a low light environment.

OFF: The instrument's backlight will not automatically turn on in a low light environment.

1. While in User Mode, use AIR to place the cursor next to **AUTO BACKLIGHT**.



2. Press and release POWER MODE. The current setting flashes.
3. Use AIR to display the desired setting.
4. Press and release POWER MODE to save the setting and return to User Mode.

Updating the Backlight Time (BACKLIGHT TIME)

This setting indicates the length of time the LCD illuminates when you press any button. The minimum setting is **OFF**; the maximum setting is **255** seconds. The factory setting is **30** seconds.

1. While in User Mode, use AIR to place the cursor next to **BACKLIGHT TIME**.



2. Press and release POWER MODE. The current setting flashes.
3. Use AIR to display the desired setting.
4. Press and release POWER MODE to save the setting and return to User Mode.

Turning the Key Tone On/Off (KEY TONE)

ON (factory setting): The instrument will beep every time a button is pressed.

OFF: The instrument will not beep when a button is pressed.

1. While in User Mode, use AIR to place the cursor next to **KEY TONE**.



2. Press and release POWER MODE. The current setting flashes.
3. Use AIR to display the desired setting.
4. Press and release POWER MODE to save the setting and return to User Mode.

Display Mode Items (D MODE SETTING)

OFF: **LIST**, **USER ID**, **STATION ID**, **INVERT SELECT**, **LCD BACKGROUND**, **BLUETOOTH**, **BUZZER VOLUME**, and **LANGUAGE** items do not appear in Display Mode.

ON (factory setting): **LIST**, **INVERT SELECT**, **LCD BACKGROUND**, **BLUETOOTH**, **BUZZER VOLUME**, and **LANGUAGE** items appear in Display Mode. **USER ID** and **STATION ID** screens appear in Display Mode if **ID DISPLAY** in Maintenance Mode is also set to **ON** (factory setting is **OFF**).

1. While in User Mode, use AIR to place the cursor next to **D MODE SETTING**.

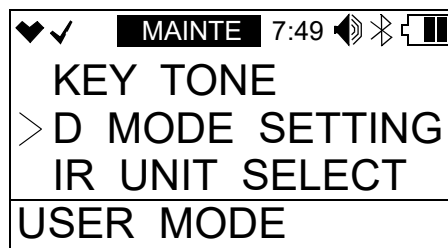

2. Press and release POWER MODE. The current setting flashes.
3. Use AIR to display the desired setting.
4. Press and release POWER MODE to save the setting and return to User Mode.

Turning Zero Suppression On/Off (ZERO SUPPRESS)

This menu item only appears if **DISP ZERO SUP** is set to **ON** in Maintenance Mode.

The **ZERO SUPPRESS** setting is not intended for field adjustment. The default setting for each sensor is **ON**.

Sensor	Zero Suppression Value
Combustible Gas	2% LEL
O ₂	0.5% volume
H ₂ S	0.3 ppm
CO	2 ppm
CO ₂	0 ppm
SO ₂	0.20 ppm

Turning Zero Follower On/Off (ZERO FOLLOWER)

This menu item only appears if **DISP ZERO FLWR** is set to **ON** in Maintenance Mode.

The **ZERO FOLLOWER** setting is not intended for field adjustment. The oxygen channel does not support zero follower functionality. The default setting is **ON** for all channels.

Reading Units for IR Sensor (IR UNIT SELECT)

This menu item only appears if a CO₂ sensor is installed. **IR UNIT SELECT** changes the IR sensor's units.

vol%: CO₂ readings displayed in percent volume

ppm: CO₂ readings displayed in parts per million

1. While in User Mode, use AIR to place the cursor next to **IR UNIT SELECT**.



2. Press and release POWER MODE. The current setting flashes.
3. Use AIR to display the desired setting.
4. Press and release POWER MODE to save the setting and return to User Mode.

CO₂ Fresh Air Adjustment On/Off (CO2AIR SETTING)

This menu item only appears if a CO₂ sensor is installed.

ON: CO₂ channel is set to 400 ppm (0.04% volume) when performing a demand zero, auto zero, or **AIR CAL**.

OFF (factory setting): CO₂ channel is not adjusted during a demand zero, auto zero, or **AIR CAL**.

1. While in User Mode, use AIR to place the cursor next to **CO2AIR SETTING**.



2. Press and release POWER MODE. The current setting flashes.
3. Use AIR to display the desired setting.
4. Press and release POWER MODE to save the setting and return to User Mode.

Setting the Date/Time (DATE)

1. From the main menu, use AIR to place the cursor next to **DATE**.



2. Press and release POWER MODE. The date and time will be displayed with the year flashing.

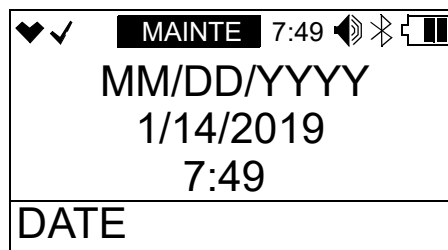

3. Use AIR to display the desired year.
4. Press and release POWER MODE to save the setting. The month setting flashes.
5. Repeat Step 3 and Step 4 to enter the month, day, hours, and minutes settings. The date and time will be saved and the instrument will return to User Mode.

Setting the Date Format (DATE FORMAT)

MM/DD/YYYY (factory setting): month/day/year.

YYYY/MM/DD: year, month, day.

DD/MM/YYYY: day, month, year.

1. While in User Mode, use AIR to place the cursor next to **DATE FORMAT**.

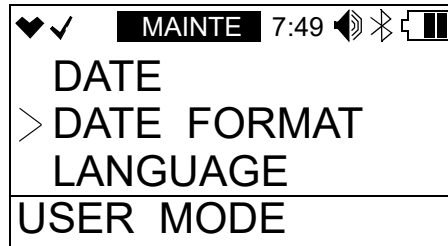

2. Press and release POWER MODE. The current setting flashes.
3. Use AIR to display the desired setting.
4. Press and release POWER MODE to save the setting and return to User Mode.

Changing the Instrument Language (LANGUAGE)

The available languages for the GX-3R Pro are: English (factory setting), Japanese, Italian, Spanish, German, French, Portuguese, Russian, Korean, and Chinese (TC).

If you change the language to anything other than English, the **LANGUAGE** screen will appear in Display Mode, allowing you to change the instrument language back to English.

1. While in User Mode, use AIR to place the cursor next to **LANGUAGE**.

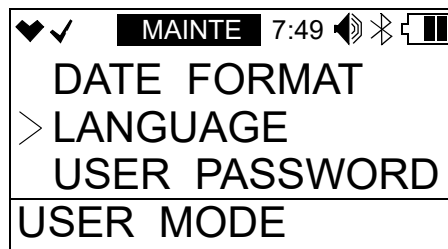

2. Press and release POWER MODE. The current setting flashes.
3. Use AIR to display the desired setting.
4. Press and release POWER MODE to save the setting and return to User Mode.

Turning the Password On/Off (USER PASSWORD)

ON: The GX-3R Pro prompts you for a password when you enter User Mode. The factory-set password is **0405** but it can be changed as desired.

OFF (factory setting): No password is required to enter User Mode.

1. While in User Mode, use AIR to place the cursor next to **USER PASSWORD**.

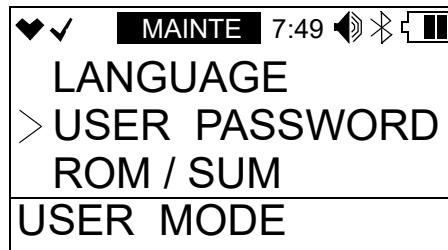

2. Press and release POWER MODE. The current setting flashes.
3. Use AIR to display the desired setting.
4. If you selected **OFF**, press and release POWER MODE to save the setting and return to the **USER PASSWORD** item in User Mode.

If you selected **ON**, continue with Step 5.

5. Press and release POWER MODE. The Set Password Screen appears. The current password is at the top of the screen with the first digit flashing.



6. Use AIR to display a number from 0 to 9.
7. Press and release POWER MODE to enter the selection and advance to the next number. To go back a number, press and hold AIR and POWER MODE for a few seconds.
8. Repeat Step 6 and Step 7 to select the remaining numbers. When you press and release POWER MODE to enter the last number, the password is saved and you return to User Mode.

Viewing the ROM/SUM (ROM/SUM)

The **ROM/SUM** screen shows the firmware version that is loaded in the instrument and the firmware checksum.

1. While in User Mode, use AIR to place the cursor next to **ROM/SUM**.



2. Press and release POWER MODE. The screen will cycle through the ROM/SUM of the main board, the ROM/SUM of the sensor board, the ROM/SUM of the IR sensor (if an IR sensor is installed), and the Bluetooth version. The ROM is the top value and the SUM is the bottom value.

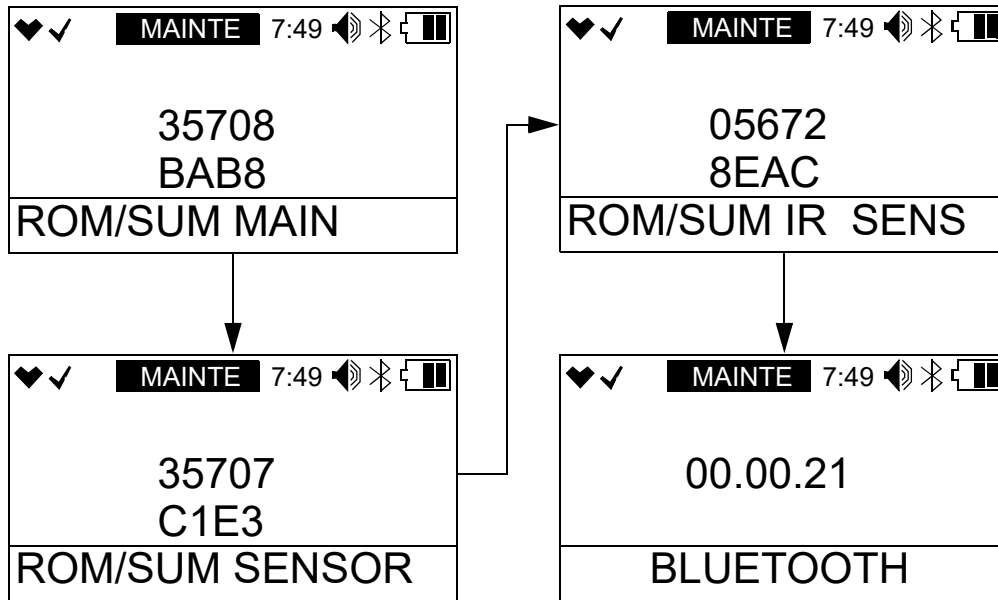

3. Press and release POWER MODE to return to User Mode.

Viewing the Radio Standards (RADIO STANDARD)

1. While in User Mode, use AIR to place the cursor next to **RADIO STANDARD**.

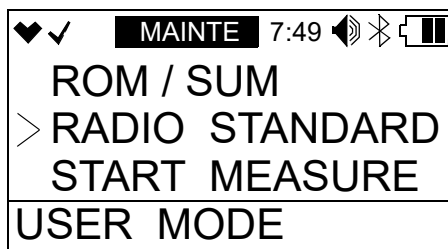

2. Press and release POWER MODE. The radio standards display.

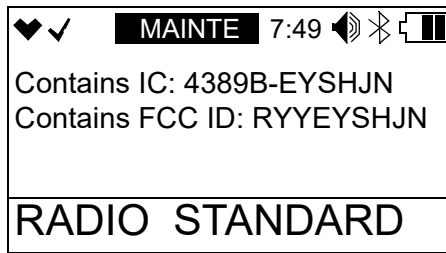

3. Press and release POWER MODE to return to User Mode.

Returning to Measuring Mode (START MEASURE)

1. While in User Mode, use AIR to place the cursor next to **START MEASURE**.

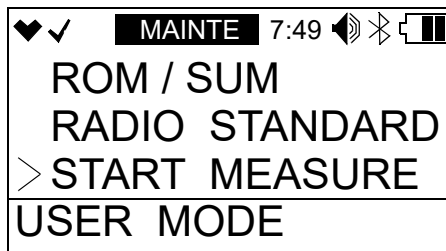

2. Press and release POWER MODE.
3. The instrument will begin its start-up sequence.

Chapter 6: Maintenance

Overview

This chapter describes troubleshooting procedures for the GX-3R Pro. It also includes procedures for replacing and recharging the batteries and replacing various consumable parts.

WARNING: *RKI Instruments, Inc. recommends that service, calibration, and repair of RKI Instruments be performed by personnel properly trained for this work. Replacing sensors and other parts with original equipment does not affect the intrinsic safety of the instrument.*

Troubleshooting

The troubleshooting table describes error messages, symptoms, probable causes, and recommended action for problems you may encounter with the GX-3R Pro.

Table 16: Troubleshooting the GX-3R Pro

Symptoms	Probable Causes	Recommended Action
<ul style="list-style-type: none">The LCD is blank.	<ul style="list-style-type: none">The unit may have been turned off.The batteries may need to be recharged.	<ol style="list-style-type: none">To turn on the unit, press and briefly hold POWER MODE.If the unit does not turn on, recharge the batteries.If the difficulties continue, contact RKI Instruments, Inc. for further instruction.
<ul style="list-style-type: none">The LCD shows abnormally high or low readings but other gas detection instruments do not.	<ul style="list-style-type: none">One of the sensor's filters may need to be replaced.The GX-3R Pro may need to be recalibrated.The sensor for the affected channel(s) may need replacement.	<ol style="list-style-type: none">Replace the sensor filter.Recalibrate the unit.If the difficulties continue, replace the sensor for the affected channel(s) and calibrate the affected channel(s).If the difficulties continue, contact RKI Instruments, Inc. for further instruction.

Table 16: Troubleshooting the GX-3R Pro

Symptoms	Probable Causes	Recommended Action
<ul style="list-style-type: none"> • Calibration fails. 	<ul style="list-style-type: none"> • The calibration values may not match the cylinder gas concentrations. • The charcoal filter or charcoal half of the dual filter is saturated causing an elevated CO reading. • The sample gas is not reaching the sensors because of a bad connection. • The calibration cylinder may be out of gas or is outdated. • The sensor for the affected channel(s) may need replacement. 	<ol style="list-style-type: none"> 1. Make sure the GX-3R Pro has been properly set up for calibration. 2. Change the charcoal filter or dual filter. 3. Check all calibration tubing for leaks or for any bad connections. 4. Verify that the calibration cylinder contains an adequate supply of fresh test sample. 5. If the fail condition continues, replace the sensor(s). 6. If the difficulties continue, contact RKI Instruments, Inc. for further instruction.
<ul style="list-style-type: none"> • Heart symbol at the top of the screen becomes steadily on or disappears 	<ul style="list-style-type: none"> • A microprocessor error has occurred. 	<ul style="list-style-type: none"> • Contact RKI Instruments, Inc. for further instruction.
<ul style="list-style-type: none"> • Charge LED alternates between green and orange 	<ul style="list-style-type: none"> • Charging environment is outside the allowed 0 - 40°C charging temperature range. 	<ul style="list-style-type: none"> • Move the charger to a location that is within the allowed 0 - 40°C charging temperature range.

Replacing the Batteries (Alkaline Version)

WARNING: *To prevent ignition of a hazardous atmosphere, batteries must only be changed in an area known to be nonhazardous.*

AVERTISSEMENT: *Pour éviter l'inflammation d'une atmosphère dangereuse, les piles ne doivent être remplacées que dans une zone non dangereuse.*

Replace the batteries when the battery icon indicates that the unit is in low battery warning. When in low battery warning, the lowest battery level indication bar disappears and the battery icon will be flashing.

Replacing Alkaline Batteries

NOTE: Use Procell PC 2400 alkaline batteries or RKI Instruments, Inc. lithium-ion battery pack 49-1625 to maintain the CSA classification of the GX-3R Pro. Use of other batteries will void the CSA classification and may void the warranty. Do not mix old/new or different types of batteries.

NOTE: Utiliser Procell 2400 piles alcalines ou RKI Instruments, Inc. pack batterie lithium-ion 49-1625 de maintenir la classification CSA de la GX-3R Pro. L'utilisation d'autres piles annule la classification CSA et peut annuler la garantie. Ne mélangez pas les anciennes/nouvelles ou différents types de piles.

1. Turn off the GX-3R Pro.

WARNING: *Do not remove the batteries while the GX-3R Pro is on.*

2. Use a coin or a screwdriver to turn the battery cover counterclockwise.
3. Carefully remove the old alkaline batteries. Verify that the battery compartment and electrical contacts are clean.
4. Carefully install the new AAA alkaline batteries according to the battery diagram inside the battery compartment.
5. Use a coin or a screwdriver to turn the battery cover clockwise.

Recharging the Batteries

WARNING: *To prevent ignition of a hazardous atmosphere, batteries must only be charged in an area known to be nonhazardous.*

AVERTISSEMENT: *Pour éviter l'inflammation d'une atmosphère dangereuse, les batteries ne doivent être chargées que dans une zone réputée non dangereuse.*

Recharge the batteries when the battery icon indicates that the unit is in low battery warning. When in low battery warning, the lowest battery level indication bar disappears and the battery icon will be flashing.

1. Make sure the GX-3R Pro is off.
2. Plug the AC adapter into an electrical outlet.
3. Connect the charging jack on the charging cable to the charging socket on the GX-3R Pro. When properly connected, a green LED will turn on at the top of the GX-3R Pro.

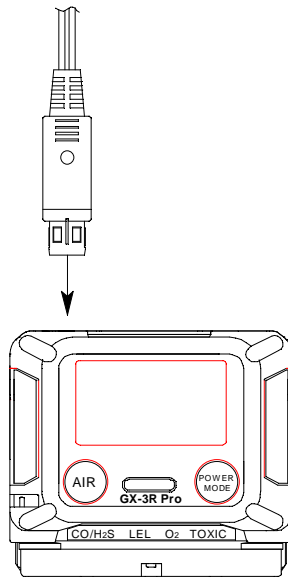

Figure 8: Connecting the Charging Cable

4. The LED at the top of the GX-3R turns orange while charging. When a full charge has been reached, approximately 3 hours, the LED turns green. Remove the charging cable from the GX-3R Pro.

Replacing the Buzzer Cover

The buzzer cover may need to be replaced if it becomes saturated or clogged with particles.

1. Remove the rubber boot from the GX-3R Pro.
2. Peel off the old buzzer cover located between the AIR and POWER MODE buttons.
3. If necessary, remove any remaining residue from the case.
4. Peel the backing off of the new buzzer cover.
5. Install the new buzzer cover between the AIR and POWER MODE buttons as shown below.

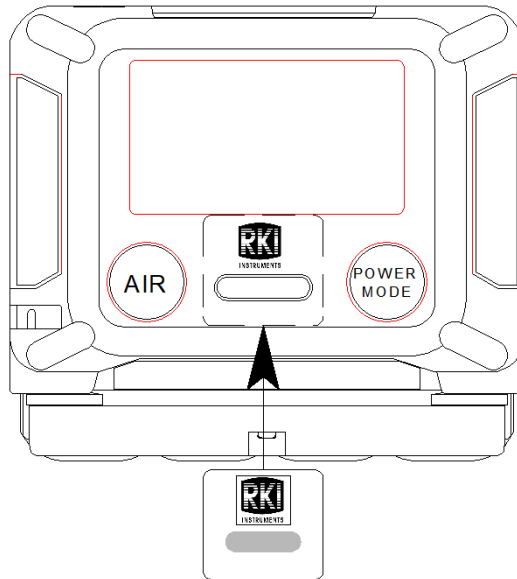

Figure 9: Buzzer Cover Replacement

6. Reinstall the rubber boot.

Replacing the Filters

Combustible Gas Sensor Filter: The H₂S filter disk is dark red in color and although it may darken over time, its color is not indicative of remaining filter life. The H₂S filter disk can absorb H₂S for 33 ppm hours and should be replaced after that much exposure. With this many ppm hours of absorption, the H₂S filter disk should be replaced after 80 minutes of exposure to 25 ppm H₂S. This equates to replacing the H₂S filter disk after 40 2-minute calibrations with a cylinder containing 25 ppm H₂S. If H₂S exists in the monitoring environment, the H₂S filter disk will have to be replaced more frequently.

CO and H₂S Sensors' Filter: The dual CO/H₂S sensor has a half black/half white filter installed over it. CO-only sensors have a black charcoal filter. H₂S-only sensors have a white humidity filter. The filter should be replaced if you notice unexplained CO and/or H₂S readings.

SO₂ Sensor Filter: The H₂S filter disk is tan in color. The filter should be replaced every 6 months.

- 1 . Verify that the GX-3R Pro is off.
- 2 . Turn the GX-3R Pro upside down.
- 3 . Use a small Phillips screwdriver to unscrew the two screws holding the bottom cover to the rest of the GX-3R Pro's case. Only unscrew them until the heads are flush with the edge of the bottom cover.
- 4 . Using a small flat blade screwdriver, gently pry each side of the bottom cover away from the rest of the GX-3R Pro's case.
- 5 . Remove the bottom cover from the rest of the GX-3R Pro's case.
- 6 . Remove the filter gasket/sensor retainer assembly.
- 7 . Remove the filter gasket and the hydrophobic dust filter.
- 8 . Gently pry out the filter you want to replace.
- 9 . Install the new filters.
 - a. Dark red H₂S scrubber disk for combustible gas sensor: The brown side of the filter case should face toward the GX-3R Pro.
 - b. Black and white combo filter for CO/H₂S dual sensor: The red side of the filter case should face toward the GX-3R Pro. The black filter material should face the edge of the GX-3R Pro while the white filter material should face the H₂S scrubber disk.
 - c. Black filter for CO-only sensor: The red side of the filter case should face toward the GX-3R Pro.
 - d. White filter for H₂S-only sensor: The white side of the filter case should face toward the GX-3R Pro.
 - e. Tan H₂S scrubber disk for SO₂ sensor: The white side of the filter case should face toward the GX-3R Pro.

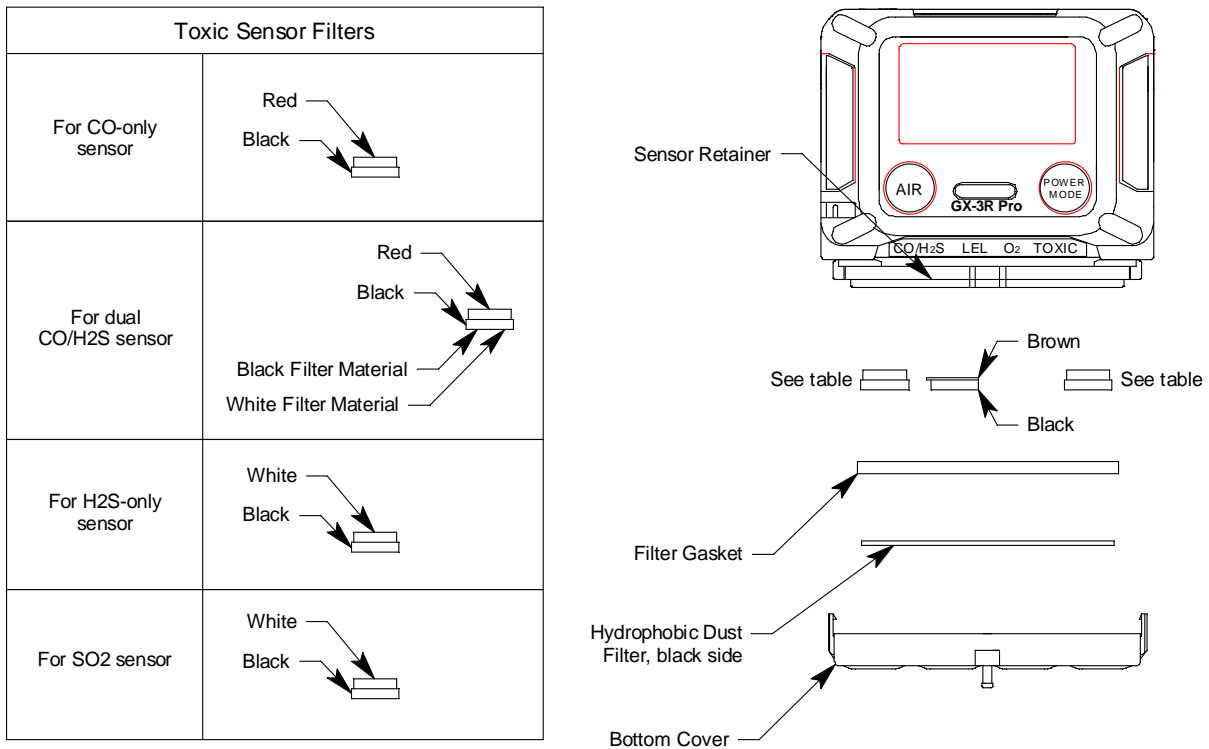

Figure 10: Replacing the Filters

- 10 . Reinstall the filter gasket and hydrophobic dust filter onto the sensor retainer. The tabs on the gasket should face toward the GX-3R Pro. The black side of the hydrophobic dust filter should be facing up.
- 11 . Reinstall the sensor retainer over the sensors.
- 12 . Reattach the bottom cover to the GX-3R Pro. Push it onto the GX-3R Pro until it snaps into place.
- 13 . Reinstall the two screws that were loosened in Step 3.

Replacing the Hydrophobic Dust Filter

- 1 . Verify that the GX-3R Pro is off.
- 2 . Turn the GX-3R Pro upside down.
- 3 . Use a small Phillips screwdriver to unscrew the two screws holding the bottom cover to the rest of the GX-3R Pro's case. Only unscrew them until the heads are flush with the edge of the bottom cover.
- 4 . Using a small flat blade screwdriver, gently pry each side of the bottom cover away from the rest of the GX-3R Pro's case.
- 5 . Remove the white hydrophobic dust filter from the filter gasket. The hydrophobic dust filter may be stuck on the bottom cover.

6. Install the new hydrophobic dust filter. Place the filter on top of the filter gasket with the black side facing up.

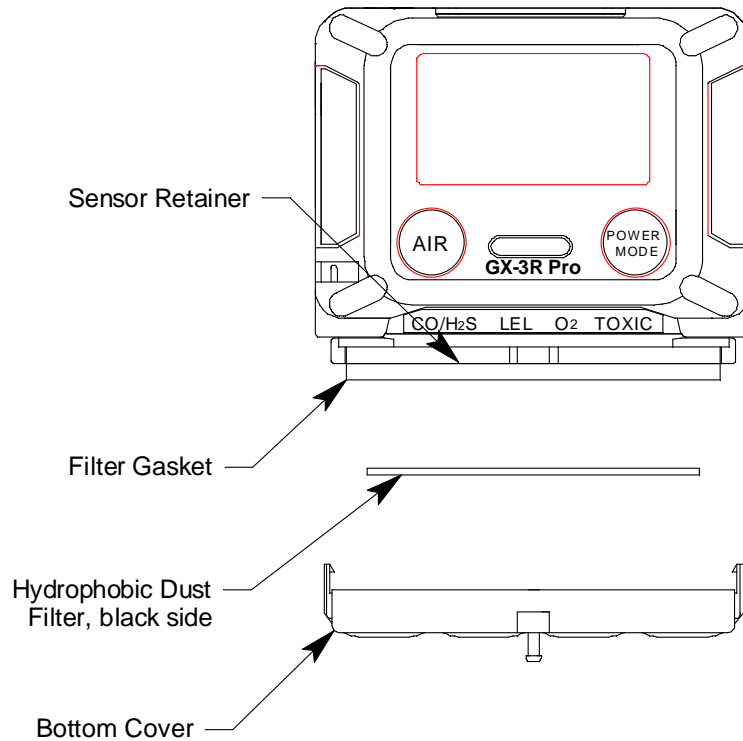

Figure 11: Replacing the Hydrophobic Dust Filter

7. Reattach the bottom cover to the GX-3R Pro. Push it onto the GX-3R Pro until it snaps into place.
8. Reinstall the two screws that were loosened in Step 3.

Replacing a Sensor

1. Verify that the GX-3R Pro is off.
2. Turn the GX-3R Pro upside down.
3. Use a small Phillips screwdriver to unscrew the two screws holding the bottom cover to the rest of the GX-3R Pro's case. Only unscrew them until the heads are flush with the edge of the bottom cover.
4. Using a small flat blade screwdriver, gently pry each side of the bottom cover away from the rest of the GX-3R Pro's case.
5. Remove the filter gasket/sensor retainer assembly from the GX-3R Pro. The sensors will be exposed.
6. Locate the sensor you want to replace and remove it from its socket.

- Carefully insert the replacement sensor in the correct socket. Be sure that the new sensor is installed in the same position as the old sensor and that it is aligned correctly. The toxic and oxygen sensors have slots to orient the sensor. The combustible gas sensor has tabs to orient the sensor. Do not force a sensor into its slot.

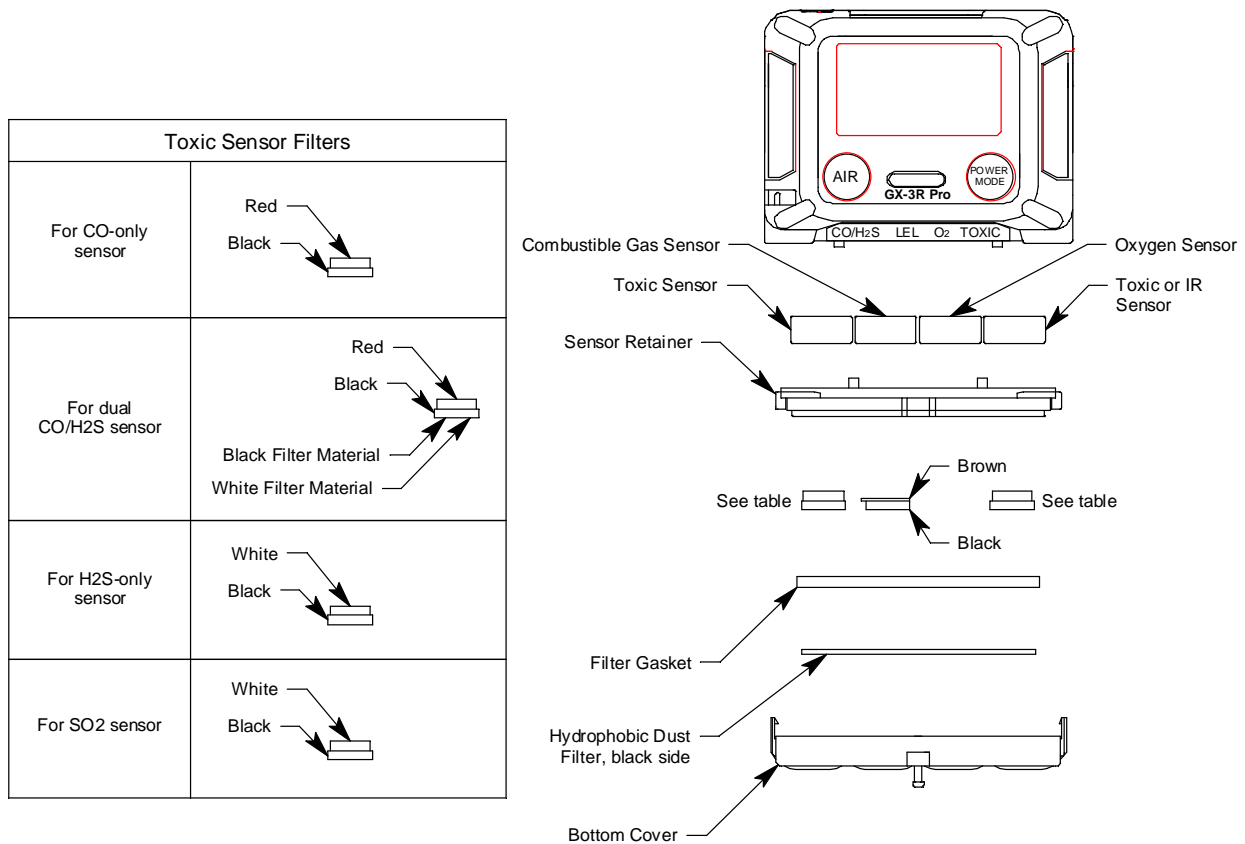

Figure 12: Replacing a Sensor

- If your instrument has a factory installed dummy sensor, ensure that it is still installed correctly. Make sure that the flat side is facing up, away from the GX-3R Pro.
- Reinstall the filter gasket/sensor retainer assembly. The black and white filter goes over the CO/H₂S sensor with the black half of the filter facing the edge of the GX-3R Pro. Be sure the filter gasket/sensor retainer is oriented correctly.
- If the hydrophobic dust filter came out, place the filter on top of the filter gasket with the black side facing up.
- Reattach the bottom cover to the GX-3R Pro. Push it onto the GX-3R Pro until it snaps into place.
- Reinstall the two screws that were loosened in Step 3.
- Calibrate the new sensors as described in “Chapter 5: User Mode and Calibration” on page 47.

Chapter 7: General Parts List

Table 17 lists part numbers for the GX-3R Pro's replacement parts and accessories.

Table 17: General Parts List

Part Number	Description
06-1248RK-03	Calibration kit tubing, 3 foot length
13-0112RK	Wrist strap
13-0124	Alligator clip
13-0125	Belt clip
20-0335	Rubber boot, black
20-0336	Heat-resistant case
20-0337	Leather case
21-1950	Screen protector
33-0182	Hydrophobic dust filter
33-0554	Buzzer cover
33-7130	Charcoal filter /humidity filter disk (black and white), for dual CO/H ₂ S sensor, 5 pack
33-7131	H ₂ S scrubber disk (dark red), for combustible gas sensor, 5 pack
33-7132	Charcoal filter disk (black), for CO and H ₂ -compensated CO sensors, 5 pack
33-7133	Humidity filter (white), for H ₂ S sensor, 5 pack
47-5093	USB/IrDA adapter with cable and CD (not for use with Eagle 2)
49-0133	AC adapter
49-1110RK	AAA battery
49-1625	Li-ion battery pack
49-1626	Alkaline battery pack
65-7004	Dummy sensor
71-0478	Operator's Manual, GX-3R Pro (this document)
71-0491	Operator's Manual, GX-3R Datalogging Program
81-0071RK-01	Calibration cylinder, 5,000 ppm CO ₂ in nitrogen, 34 liter steel
81-0071RK-03	Calibration cylinder, 5,000 ppm CO ₂ in nitrogen, 103 liter
81-0072RK-01	Calibration cylinder, 2.5 %vol CO ₂ in nitrogen, 34 liter steel
81-0072RK-03	Calibration cylinder, 2.5 %vol CO ₂ in nitrogen, 103 liter
81-0090RK-01	Calibration cylinder, 3-gas (CH ₄ /O ₂ /CO), 34 liter steel

Table 17: General Parts List (cont.)

Part Number	Description
81-0090RK-03	Calibration cylinder, 3-gas (CH ₄ /O ₂ /CO), 103 liter
81-0142RK-02	Calibration cylinder, 5-gas (SO ₂ , CH ₄ , O ₂ , H ₂ S, CO), 58 liter
81-0142RK-04	Calibration cylinder, 5-gas (SO ₂ , CH ₄ , O ₂ , H ₂ S, CO), 34 liter aluminum
81-0154RK-02	Calibration cylinder, 4-gas (CH ₄ /O ₂ / H ₂ S/CO), 58 liter
81-0154RK-04	Calibration cylinder, 4-gas (CH ₄ /O ₂ / H ₂ S/CO), 34 liter aluminum
81-0170RK-02	Calibration cylinder, 5 ppm SO ₂ in nitrogen, 58 liter
81-0170RK-04	Calibration cylinder, 5 ppm SO ₂ in nitrogen, 34 liter aluminum
81-1050RK-25	Regulator, fixed flow, 0.25 LPM, with gauge and knob, for 17 liter and 34 liter steel cylinders (cylinders with external threads)
81-1051RK-25	Regulator, fixed flow, 0.25 LPM, with gauge and knob, for 34 liter aluminum, 58 liter, and 103 liter cylinders (cylinders with internal threads)
81-1193	Calibration cup
81-GX3RCO	Calibration kit: 103 liter 3-gas (CH ₄ /O ₂ /CO) cylinder, 0.25 LPM regulator, calibration tubing, and case
81-GX3RCO-LV	Calibration kit: 34 liter steel 3-gas (CH ₄ /O ₂ / CO) cylinder, 0.25 LPM regulator, calibration tubing, and case
81-GX3RHSCO	Calibration kit: 58 liter 4-gas (CH ₄ /O ₂ / H ₂ S/CO) cylinder, 0.25 LPM regulator, calibration tubing, and case
81-GX3RHSCO-LV	Calibration kit: 34 liter aluminum 4-gas (CH ₄ /O ₂ / H ₂ S/CO) cylinder, 0.25 LPM regulator, calibration tubing, and case
81-GX3RHSCO-116	Calibration kit: 116 liter aluminum 4-gas (CH ₄ /O ₂ / H ₂ S/CO), 0.25 LPM regulator, calibration tubing, and case
81-PAA	Calibration kit: 58 liter 4-gas (CH ₄ /O ₂ / H ₂ S/CO) cylinder, 103 liter 5000 ppm CO ₂ in N ₂ cylinder, two 0.25 LPM regulators, calibration tubing, and case
81-PAA-LV	Calibration kit: 34 liter aluminum 4-gas (CH ₄ /O ₂ / H ₂ S/CO) cylinder, 34 liter steel 5000 ppm CO ₂ in N ₂ cylinder, two 0.25 LPM regulators, calibration tubing, and case
81-PAB	Calibration kit: 58 liter 4-gas (CH ₄ /O ₂ / H ₂ S/CO) cylinder, 103 liter 2.5% volume CO ₂ in N ₂ cylinder, two 0.25 LPM regulators, calibration tubing, and case
81-PAB-LV	Calibration kit: 34 liter aluminum 4-gas (CH ₄ /O ₂ / H ₂ S/CO) cylinder, 34 liter steel 2.5% volume CO ₂ in N ₂ cylinder, two 0.25 LPM regulators, calibration tubing, and case
81-PAC	Calibration kit: 58 liter 5-gas (CH ₄ /O ₂ / H ₂ S/CO/SO ₂) cylinder, 0.25 LPM regulator, calibration tubing, and case
81-PPA	103 liter 5000 ppm CO ₂ in N ₂
81-PPA-LV	34 liter steel 5000 ppm CO ₂ in N ₂

Table 17: General Parts List (cont.)

Part Number	Description
ESR-A13D	Sulfur dioxide (SO ₂) sensor
ESR-A13i	Hydrogen sulfide (H ₂ S) sensor
ESR-A13P	Carbon monoxide (CO) sensor
ESR-A1CP	Hydrogen-compensated carbon monoxide (CO) sensor
ESR-A1DP	Dual carbon monoxide (CO) and hydrogen sulfide (H ₂ S) sensor
ESR-X13P	Oxygen sensor
IRR-0409	Carbon dioxide (CO ₂) sensor, 0 - 10% volume
IRR-0433	Carbon dioxide (CO ₂) sensor, 0 - 10,000 ppm
NCR-6309	Combustible gas sensor, catalytic

Appendix A: RK Link Phone App

Installing the App

1. Download and install the “RK Link” app from the App Store (for iOS) or Google Play (for Android).
2. Launch the RK Link app.
3. Allow to access device location.
4. Allow to access contacts.
5. Allow to access photos, media, and files.
6. Choose a gmail account and press “OK”. This will be used to send the alert emails.
7. If you do not have an account, select “Add account” and press “OK”. Create a gmail account, then select the new gmail account in the RK Link window.

Important Setup Notes

1. Make sure no other Bluetooth devices are connected to your phone.
2. Make sure the phone’s location services are turned on. If they’re not, the coordinates in the email that gets sent won’t have any meaning.
3. For iPhones:
 - a. Open an Internet browser.
 - b. Access your google account.
 - c. Access the “manage google account” portion of the account.
 - d. Go to “Sign-in and Security”
 - e. Be sure that “Less secure apps” is turned on.

Pairing a GX-3R Pro

Multiple instruments cannot be paired with the same phone. Similarly, one instrument cannot be paired with multiple phones.

If a paired GX-3R Pro is turned off, it must be paired with the app again when it is turned back on.

If the app is closed while a GX-3R Pro is paired, the GX-3R Pro must be paired with the app again when the app is reopened.

1. Open the RK Link app.
2. Be sure your GX-3R Pro is turned on.
3. Be sure the GX-3R Pro’s Bluetooth is turned on in the Display Mode.

4. Press “Pairing”.

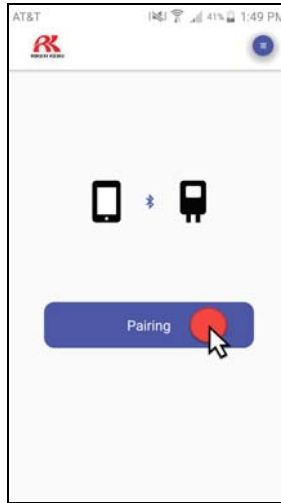

5. Press “Manual pairing”. If your phone’s Bluetooth is not turned on, the app will prompt you to turn it on. Press “Yes”. Then press “Manual pairing” again.

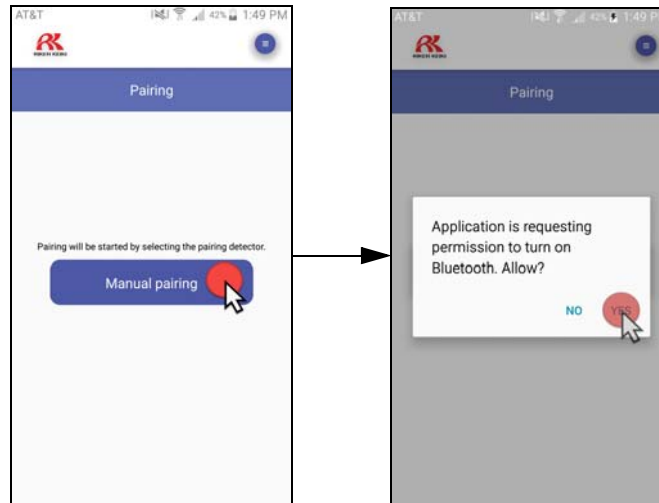

6. Select the GX-3R Pro you’d like to pair with then press “Pairing”.

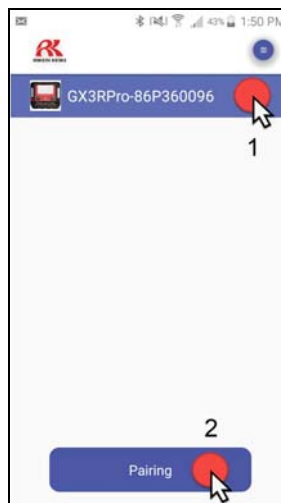

7. A “Connection completed” message will appear once the GX-3R Pro is connected to your phone. Press “OK”.

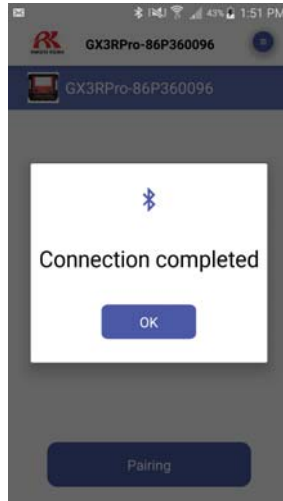

8. The Measuring Mode screen will display.



Searching for a Paired GX-3R Pro

Using the app's detector search function allows you to find a connected GX-3R Pro that may have been set down somewhere.

NOTE: This feature does not work if the GX-3R Pro is operating in stealth mode.

1. Press the  button in the upper right corner of the app.



2. If necessary, scroll down to make "Detector search" visible.
3. Press "Detector search". The GX-3R Pro's buzzer, LEDs, and vibrator will activate *unless the GX-3R Pro is operating in Stealth Mode*. If the GX-3R Pro is operating in Stealth Mode, the GX-3R Pro will not respond to a detector search.

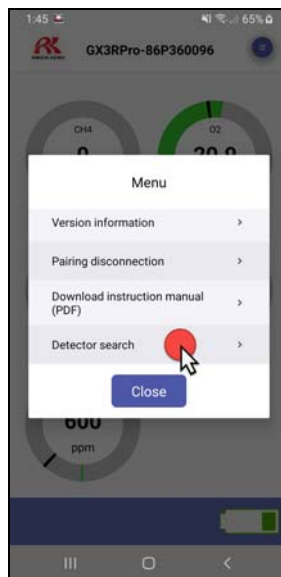

Disconnecting a Paired GX-3R Pro

1. Press the  button in the upper right corner of the app.

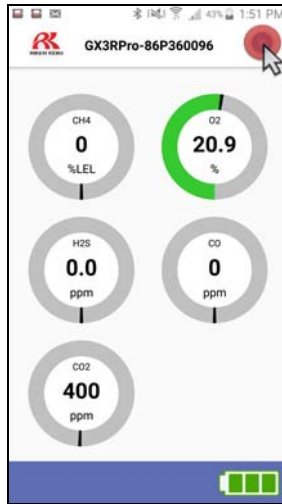

2. If necessary, scroll down to make “Pairing disconnection” visible.
3. Press “Pairing disconnection”. The GX-3R Pro will be disconnected from the phone but will remain on and functional.

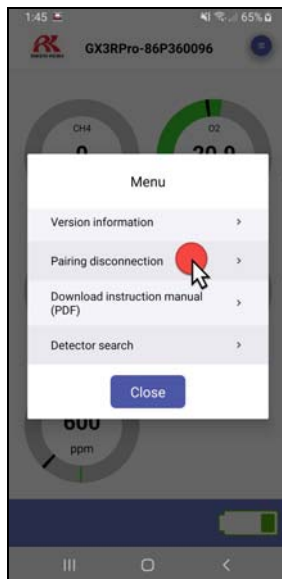

Adjusting App Notification Settings

1. Press the  button in the upper right corner of the app.

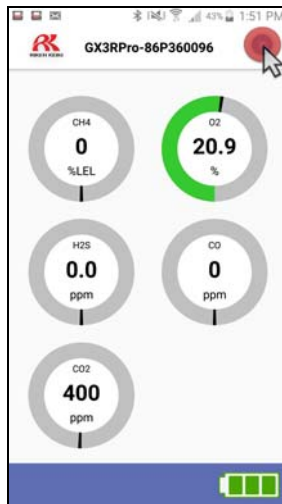

2. Press “Application settings”.



3 . The app notification settings appear.

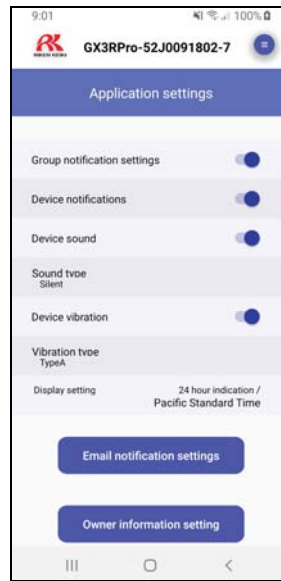

- Group notification settings: If set to on, emails and text messages are sent out as long as the Group Settings window is set up appropriately. If set to off, emails and text messages are not sent out even if the Group Settings window is set up appropriately.
- Device notifications: If set to on, the app provides notifications for past due bump tests or calibrations, gas alarms, man down alarms, and any faults. Notifications can be viewed in your phone's notification bar. If set to off, the app does not provide notifications.
- Device sound: If set to on, the app produces a notification sound. If set to off, the app does not produce a notification sound.
- Sound type: Define the app's notification sound.
- Device vibration: If set to on, the app vibrates when a notification occurs. If set to off, the app does not vibrate when a notification occurs.
- Vibration type: Define the app's vibration pattern.
- Display setting: Indicates the time format and time zone. This is not adjustable.

Defining Owner Information

Owner information can be defined with or without a GX-3R Pro paired with the app. Owner information gets sent out with email alerts along with the station ID and user ID from the GX-3R Pro.

1. Press the  button in the upper right corner of the app.

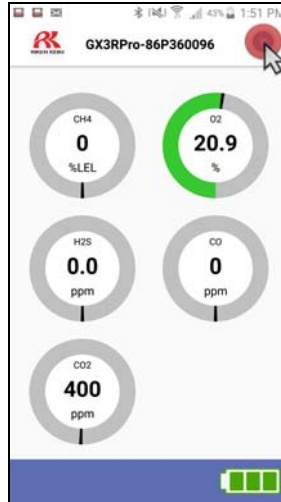

2. Press “Application settings”.

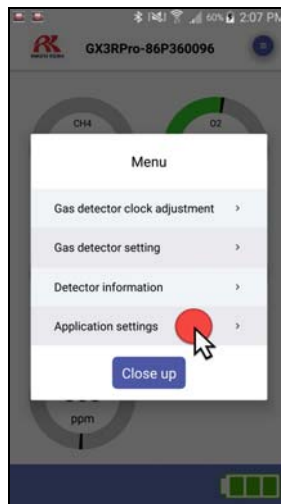

3. Press “Owner information setting” at the bottom of the screen. You may need to scroll down to make it visible.

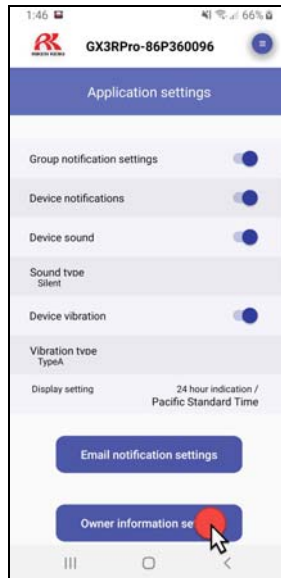

4. Type in the name, company name, and department name.



Setting Up Email Alerts

Email alert setup can be done with or without a GX-3R Pro paired with the app.

Occurrence Time: 4/30/19 15:51
Location: 37.5995954,-122.0361591
<https://www.google.co.jp/maps?q=37.5995954,-122.0361591>
Serial No.: 86P360096
Manufacturing No.: 86P360096
Description: Remind:BUMP test deadline O2/H2S/CO2
User ID: KIMBERLY
Station ID: DESK
Device Name: GX-3RPro

Gas Name:	CH4	O2	H2S	CO	CO2
Full Scale:	100%LEL	40.0%	200.0ppm	2000ppm	100000ppm
Warning:	10%LEL	18.0%	1.0ppm	25ppm	5000ppm
Alarm:	50%LEL	18.0%	10.0ppm	50ppm	5100ppm
AlarmH	50%LEL	25.0%	10.0ppm	50ppm	7500ppm
STEL:	----	----	5.0ppm	200ppm	30000ppm
TWA:	----	----	1.0ppm	25ppm	5000ppm
Concentration:	-	-	-	-	-

Owner Information: Test1
Company Name: Test2
Department Name: Test3

Figure 13: Email Alert for Past Due Bump Test

1. Press the  button in the upper right corner of the app.

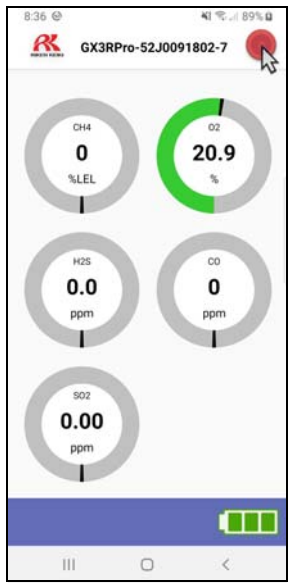

GX-3R Pro Connected



GX-3R Pro Disconnected

2. Press “Application settings”.



3. Press “Email notification settings” at the bottom of the screen.

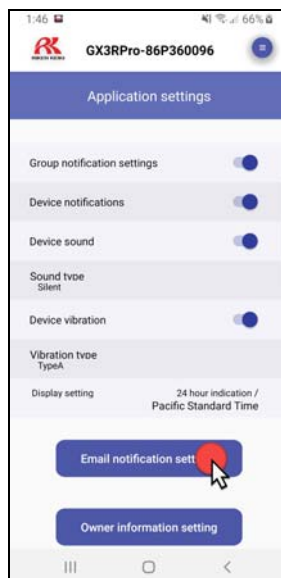

4. Press “Group settings”.

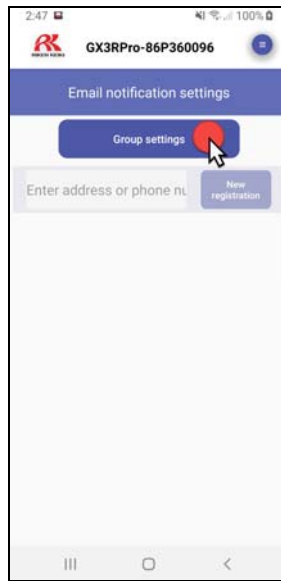

5. Type in a group name and press “New registration”.

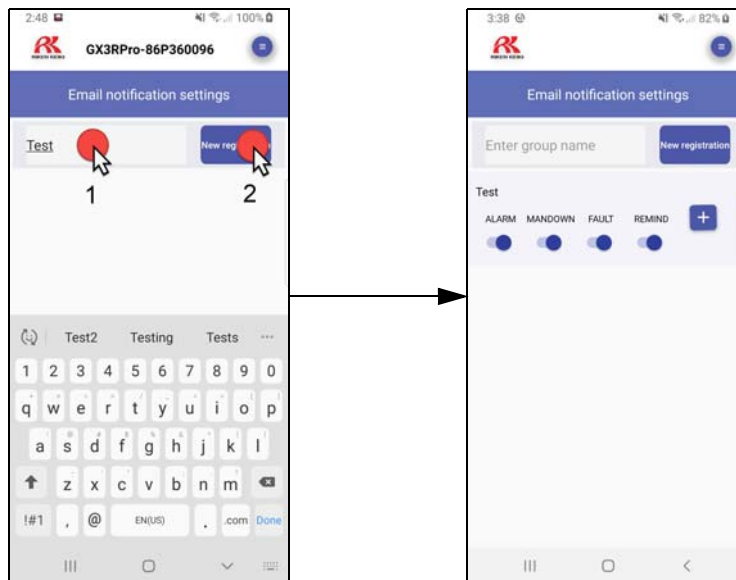

6. To delete a group name once it's entered:
 - a. Press the  button.
 - b. Press “Delete group”. You may need to scroll down to make “Delete group” visible.
 - c. Press each group you want to delete. A check mark will appear to the right of the group name.

d. Press “OK” at the bottom of the screen.

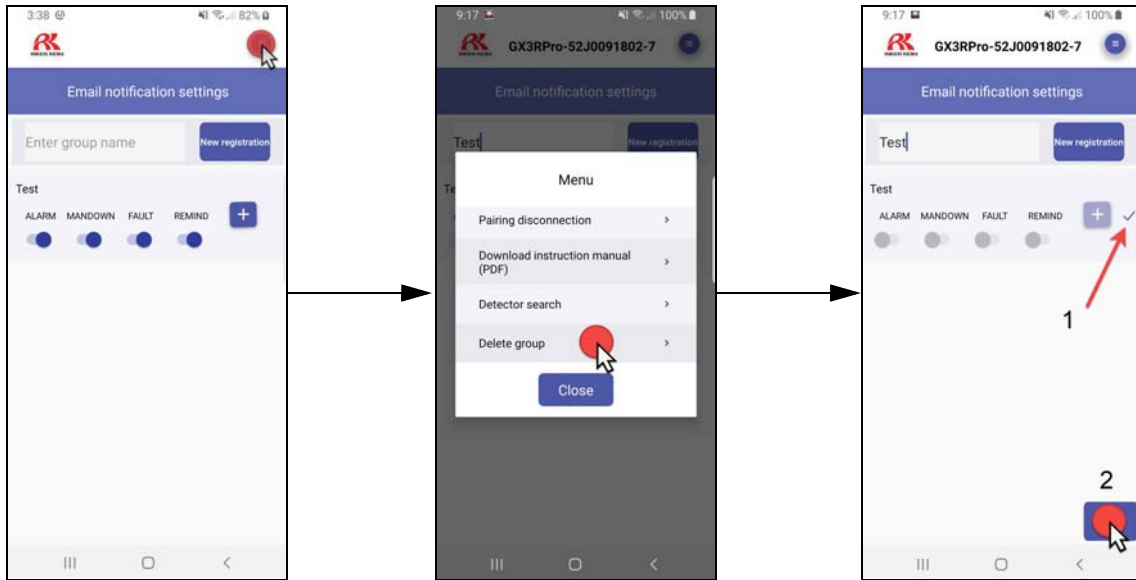

7. Choose the alarm types that will initiate an email alert then press the “plus” symbol.

- ALARM: Sends an alert or notification for any gas alarm (warning, alarm, alarm H, STEL, TWA).
- MANDOWN: Sends an alert or notification for a man down alarm.
- FAULT: Sends an alert or notification for any sort of instrument failure. battery, sensor fail
- REMIND: Sends an alert or notification if the instrument is due for a bump test or calibration regardless of the instruments reminder on/off setting.

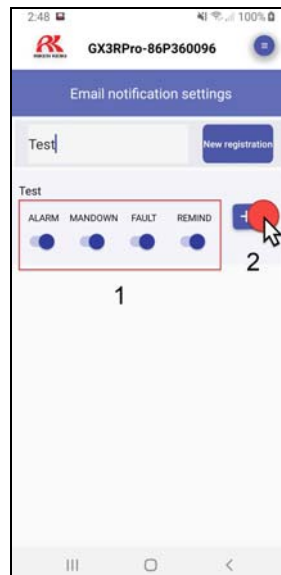

8. Type in an email address and press “New registration” to add the email address to the list.

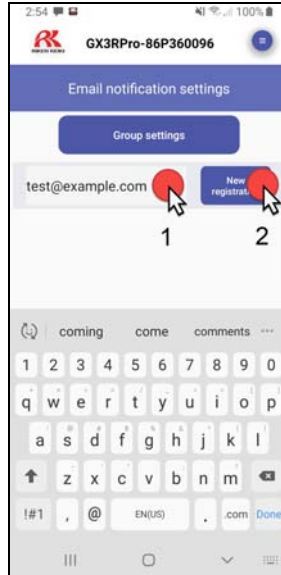

9. To add contacts from your phone:

- Press the  button.
- Press “Register from Phone Book”. You may need to scroll down to make “Register from Phone Book” visible.
- Select each contact you want to use. A check mark will appear to the right.

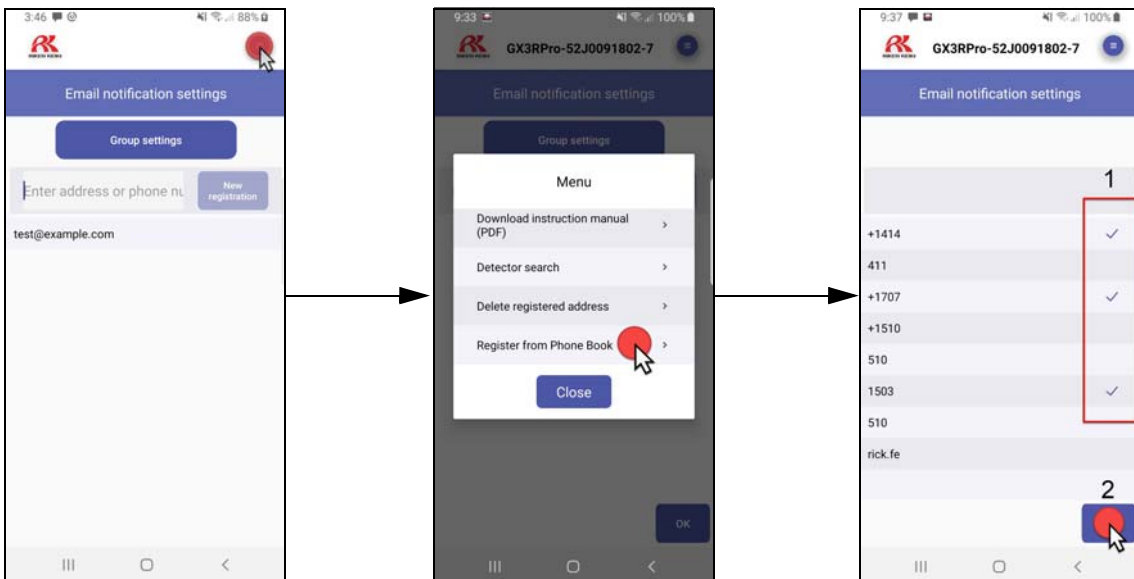

- 10 . Press the new email address and confirm that a check mark appears to the right of the email address. If the email address does not have a check mark next to it, that email will not be included in the email alert!



- 11 . To delete an email address once it's entered:

- Press the  button.
- Press "Delete registered address". You may need to scroll down to make "Delete registered address" visible.
- Press each email address you want to delete. A check mark will appear to the right of the email address.
- Press "OK" at the bottom of the screen.

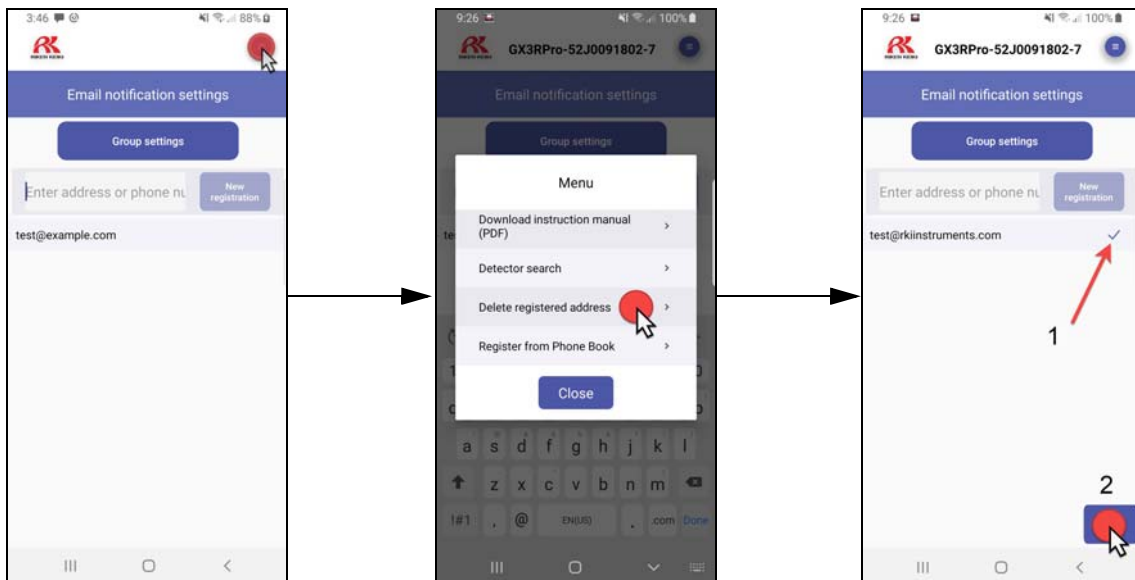

- 12 . Press OK. You will be returned to the group settings screen. If you want to add another group, type in a new name and press “New registration”. Repeat steps 6 - 9.
- 13 . Use your phone’s “Back” button to return to the Measuring Mode screen.

Setting the Date/Time in the GX-3R Pro

- 1 . From the home screen, press the  button in the upper right corner of the app.

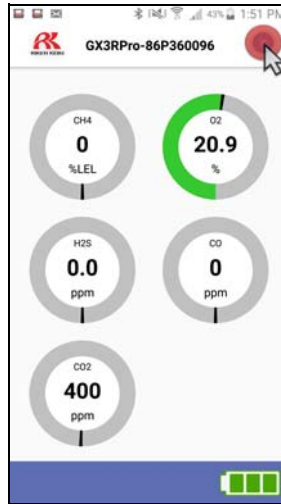

- 2 . Press “Gas detector clock adjustment”.

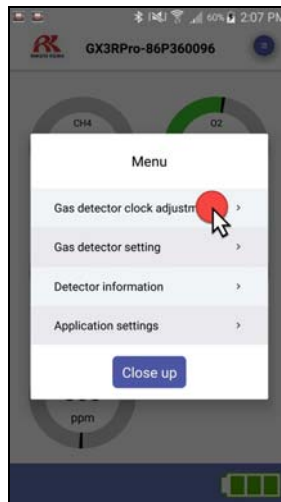

- 3 . The Menu will close and the GX-3R Pro’s date/time will be adjusted to match the phone’s date/time.

Changing GX-3R Pro Parameters

GX-3R Pro parameters can only be viewed or changed when a GX-3R Pro is paired with the app.

Entering the Gas Detector Setting Menu

1. From the home screen, press the  button in the upper right corner of the app.

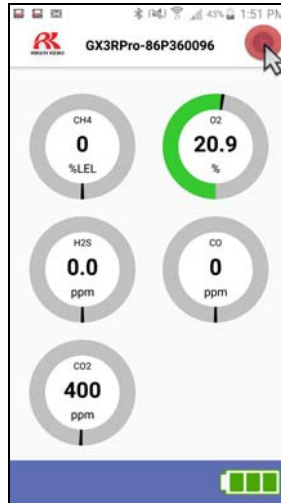

2. Press “Gas detector setting”.

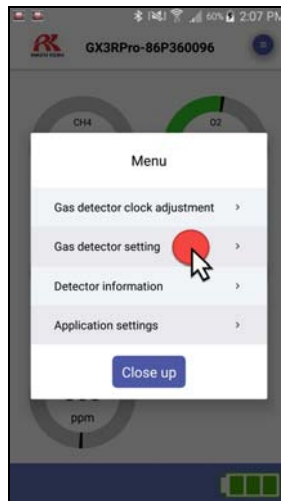

3. Type in the password and press “OK”. The password depends on your instrument settings.
 - For brand new instruments whose User Mode Password parameter has not been adjusted, the password is **0000**.
 - If you turned your instrument’s User Mode Password on, the app’s password is your instrument’s User Mode password.
 - If you turned your instrument’s User Mode Password on but then turned it off, the app password is still the instrument’s old User Mode password. The app password does not go back to **0000** after you turn off the instrument’s User Mode password.

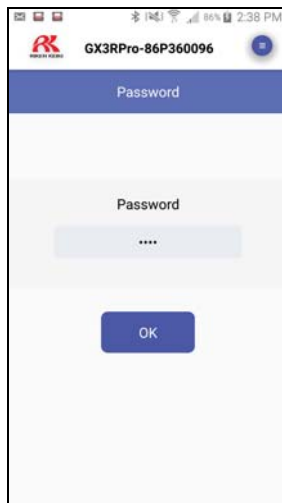

Alarm Settings

1. Access the Gas Detector Setting Menu as described on pg.119.
2. Press “Alarm Setting”.

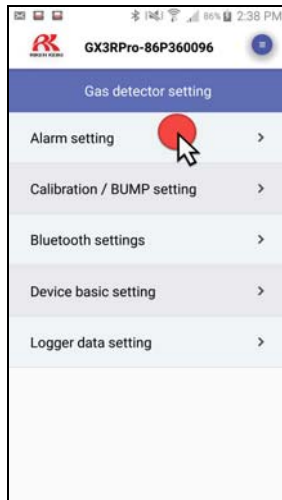

3. Press the channel whose alarm points you want to view or change. The H₂S channel is selected in the example below.

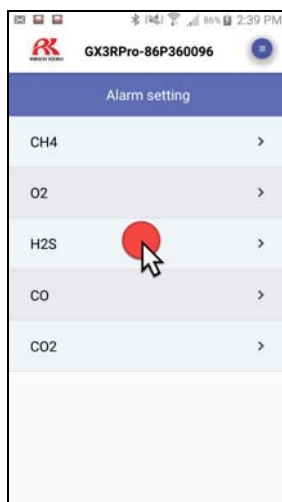

- The alarm points will be displayed.

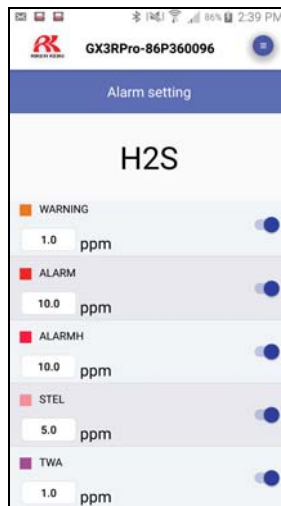

- Turn the alarms on or off with the toggle button next to each alarm type.
- Adjust the alarm setpoints by pressing the current setpoint and scrolling to the desired value.

Calibration and Bump Settings

- Access the Gas Detector Setting Menu as described on pg.119.
- Press “Calibration/BUMP Setting”.

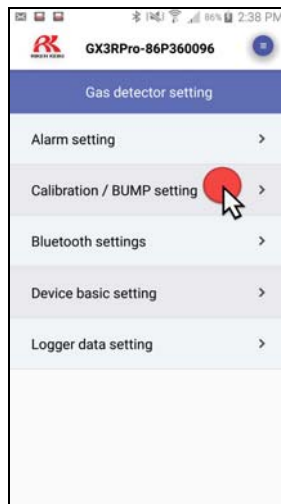

3. Turn the calibration and bump test reminder screens on or off with the toggle buttons. Set the calibration and bump test intervals.

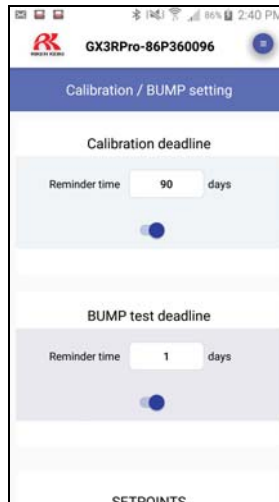

4. Scroll down to view or change the auto calibration value for each channel.



Bluetooth Settings

1. Access the Gas Detector Setting Menu as described on pg.119.
2. Press “Bluetooth Settings”.

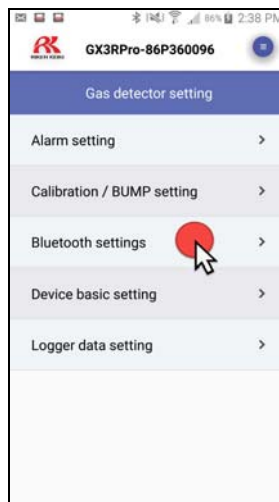

3. Disconnection determination time: Define the number of seconds that you want to pass between a connection being lost and a “lost connection” notification.

Pairing timeout setting: Define the number of seconds that you want to pass between the start of a detector search and a timeout from the search.

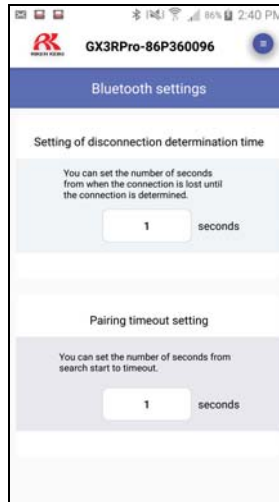

Basic Device Settings

1. Access the Gas Detector Setting Menu as described on pg.119.
2. Press “Device Basic Setting”.

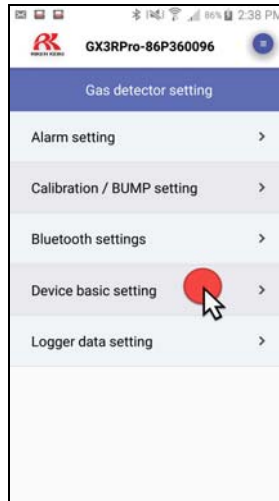

3. Press “Language settings”.

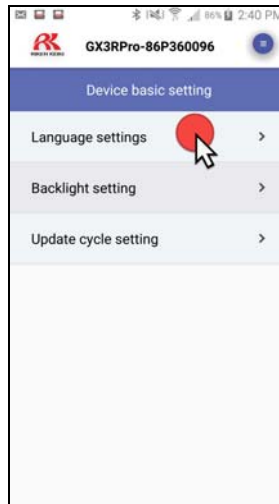

4. Select the language you want to use.



5. Press your phone’s “Back” button.

6. Press “Backlight setting”.

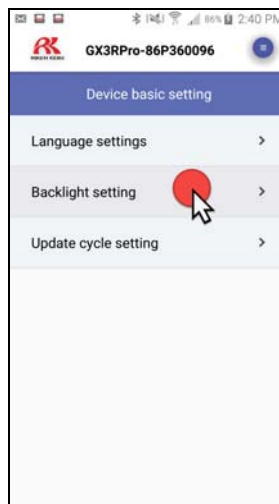

7. Set how long (in seconds) you want the backlight to stay on after each button press. The options are 0-255 seconds. The factory setting is 30 seconds.

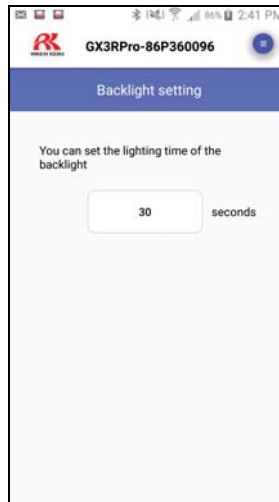

8. Press your phone's "Back" button.
9. Press "Update cycle setting".

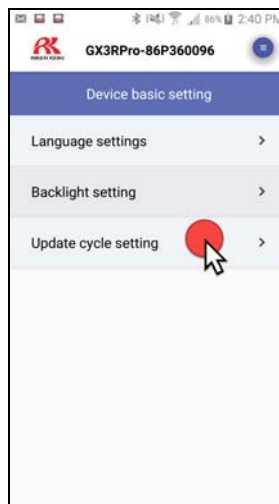

10. Set how often you want the app to refresh the readings.

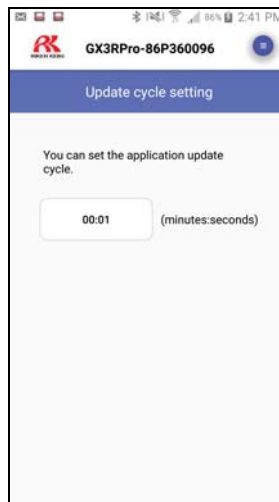

11. Press your phone's "Back" button.

Logger Data Settings

1. Access the Gas Detector Setting Menu as described on pg.119.
2. Press “Logger Data Setting”.

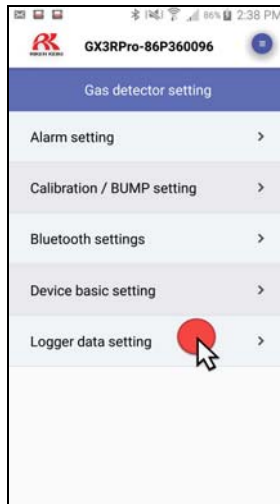

3. Set the interval trend time, Station ID, and User ID. The serial number is not editable.

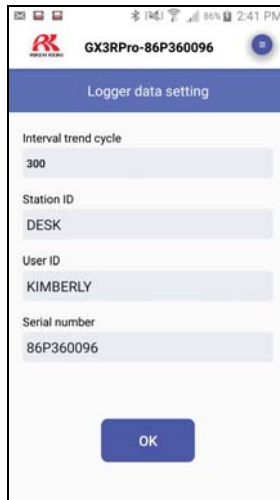

4. Press “Send”. There is no confirmation that the information sent.

Viewing Serial Number, IDs, and Bump/Cal Information

Serial number, ID, and bump/cal information can only be viewed when a GX-3R Pro is paired with the app.

1. Press the  button in the upper right corner of the app.

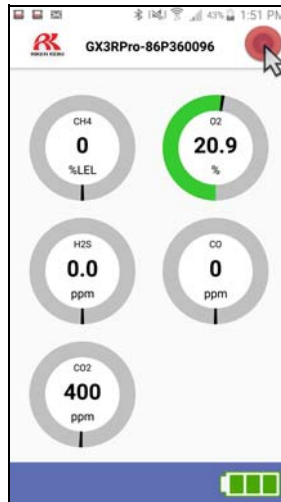

2. Press “Detector information”.

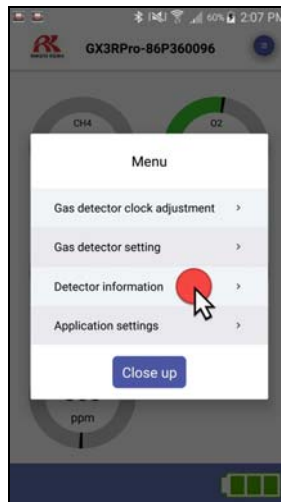

3. Detector information will display.

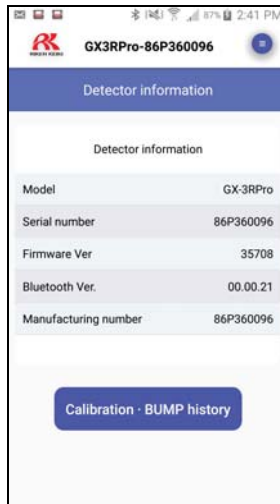

4. To view information for the last successful calibration and bump test, press the “Calibration BUMP history” button.



5. The instrument’s serial number, station ID, user ID, and part of the calibration information will display.



6. Scroll down to view the complete calibration information and/or the bump test information.

	Calibration date / time	Before calibration	After calibration	Calibration concentration	Calibration interval
CH4 100%LEL	2019 03/22 10:14:44	52	50	50	76
O2 40.0%	2019 03/22 10:14:44	11.9	12.0	12.0	76
H2S 200.0ppm	2019 03/22 10:14:44	41.5	25.0	25.0	76
CO 2000ppm	2019 03/22 10:14:44	51	50	50	76
CO2 100000ppm	2018 10/15 11:19:09	26200	25000	25000	None

Viewing App Version Info

App version information can be viewed with or without a GX-3R Pro paired with the app.

1. Press the  button in the upper right corner of the app.



2. If necessary, scroll down to make “Version information” visible.

3. Press “Version information”.

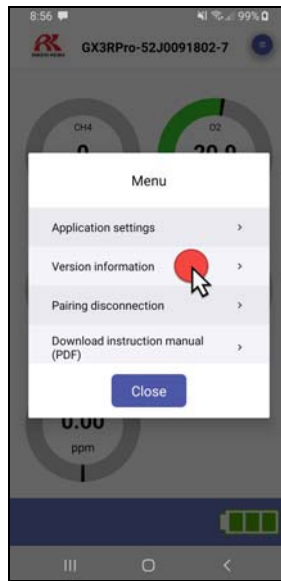

4. Instrument information and app information will display.



5. To view the license information, press “License information”.

Appendix B: Maintenance Mode

Overview

This appendix describes the GX-3R Pro in Maintenance Mode. The GX-3R Pro is factory-set to suit most applications. Update settings in Maintenance Mode only if required for your specific application. Maintenance Mode items and their factory settings are listed in Table 18 below.

Table 18: Maintenance Mode Menu Items

Maintenance Mode Menu Item	Description	
GAS CAL (pg.134)	Perform an air adjust, perform a span adjustment, change the calibration values, set the cylinder group.	
	AIR CAL Perform a fresh air adjustment.	
	CO2 ZERO CAL* Perform a zero adjustment on the CO ₂ channel using 100% nitrogen.	
	AUTO CAL	Perform a span adjustment, set the calibration gas concentration, and set the cylinder for each gas.
		AUTO CAL CYL X Perform an automatic span adjustment on the gases selected for Cylinder X.
		SETTING CAL-P Set the calibration gas concentration for each gas.
		CYL SETTING Assign a cylinder (A-E) to each gas. Multiple gases can be assigned to the same cylinder.
		ESCAPE Return to the AUTO CAL menu item.
ESCAPE Return to the GAS CAL menu item.		
GAS TEST (pg.134)	Apply gas to test sensor response and observe alarm indications without an alarm event being recorded.	
SENSOR DATE (pg.136)	View the replacement date for each sensor and the battery and/or set the replacement date for each sensor or the battery to the current date.	
BUMP TEST (pg.137)	Perform a bump test.	
LATCHING (pg.138)	ON (factory setting): The GX-3R Pro remains in alarm until the alarm condition passes <i>and</i> POWER MODE is pressed. OFF: The GX-3R Pro automatically resets an alarm when the alarm condition passes.	
DEMAND ZERO (pg.138)	ON (factory setting): You can manually perform a fresh air adjust in Measuring Mode by pressing AIR. OFF: You cannot manually perform a fresh air adjust in Measuring Mode by pressing AIR.	

Table 18: Maintenance Mode Menu Items

Maintenance Mode Menu Item	Description
AUTO ZERO (pg.139)	<p>ON: The GX-3R Pro will ask if you want to perform a fresh air adjustment at the end of the startup sequence.</p> <p>OFF (factory setting): The GX-3R Pro does not ask if you want to perform a fresh air adjustment at the end of the startup sequence.</p>
ID DISPLAY (pg.139)	<p>ON: User ID and Station ID screens appear in startup sequence. IDs can be changed in Display Mode. IDs can be edited in Display Mode if D MODE SETTING in User Mode is also set to ON.</p> <p>OFF (factory setting): User ID and Station ID screens do not appear in startup sequence. IDs cannot be changed in Display Mode.</p>
ZERO SUPPRESS (pg.140)	<p>ON (factory setting): Not intended for field adjustment. The suppression values are: Combustible gas: 2% LEL O₂: 0.5% volume H₂S: 0.3 ppm CO: 2 ppm CO₂: 0 ppm SO₂: 0.20 ppm</p>
ZERO FOLLOWER (pg.140)	<p>Not intended for field adjustment. Oxygen channel does not support zero follower functionality. Factory setting for all other channels is ON.</p>
DISP ZERO SUP (pg.140)	<p>ON: Zero suppression menu item appears in User Mode.</p> <p>OFF (factory setting): Zero suppression menu item does not appear in User Mode. (Zero suppression menu item is always available in Maintenance Mode)</p>
DISP ZERO FLWR (pg.140)	<p>ON: Zero follower menu item appears in User Mode.</p> <p>OFF (factory setting): Zero follower menu item does not appear in User Mode. (Zero follower menu item is always available in Maintenance Mode)</p>
DATE (pg.141)	<p>Set the current date and time.</p>
DATE FORMAT (pg.141)	<p>MM/DD/YYYY (factory setting): month/day/year YYYY/MM/DD: year/month/day DD/MM/YYYY: day/month/year</p>
LANGUAGE (pg.142)	<p>Set the language of the instrument. Options: English (factory setting), Japanese, Italian, Spanish, German, French, Portuguese, Russian, Korean, Chinese (TC)</p>
MAINT PASSWORD (pg.142)	<p>ON (factory setting): A password is needed to access Maintenance Mode. Factory-set password is 8102.</p> <p>OFF: No password is needed to access Maintenance Mode.</p>
ROM/SUM (pg.143)	<p>View the firmware information for the GX-3R Pro's sensor board and main board.</p>
LCD CONTRAST (pg.144)	<p>1-50 (factory setting 20)</p>
M.DEFAULT (pg.145)	<p>Set all parameters back to their RKI factory settings.</p>

Table 18: Maintenance Mode Menu Items

Maintenance Mode Menu Item	Description
START MEASURE (pg.145)	Press and release POWER MODE to begin the warmup sequence and enter Measuring Mode.
* Only appears in units with a CO ₂ sensor installed.	

Entering Maintenance Mode

WARNING: *The GX-3R Pro is not in operation as a gas detector while in Maintenance Mode.*

1. Take the GX-3R Pro to a non-hazardous location and turn it off if it is on.
2. Press and hold AIR, then press and hold POWER MODE. You will hear a beep after one second. Continue to hold the buttons down.
3. When you hear a second beep, release the buttons.
4. The screen that appears will depend on the setting of Maintenance Mode’s **MAINT PASSWORD** item.

If **MAINT PASSWORD** is set to **OFF**, continue with Step 7.

If **MAINT PASSWORD** is set to **ON** (factory setting), continue with Step 5.



MAINT PASSWORD set to **OFF**



MAINT PASSWORD set to **ON**

5. If **MAINT PASSWORD** has been set to **ON** in Maintenance Mode, a password screen will appear. The first digit will be flashing. The factory-set password is **8102** but it can be changed as desired.
6. Use AIR to select each password number then press POWER MODE to save it and move on to the next number. To go back a number, press and hold AIR and POWER MODE for a few seconds. To reverse the direction of change (ie. from increasing to decreasing or vice versa):
 - a. Press and hold AIR.
 - b. Immediately press POWER MODE and then release both buttons.

7. The Maintenance Mode menu displays.

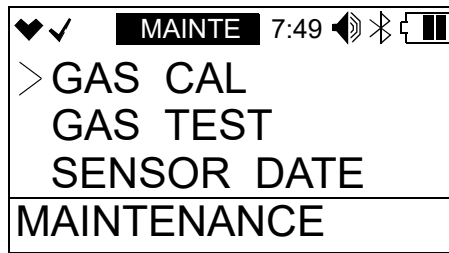

8. Use AIR to move through the Maintenance Mode menu items.

Tips for Using Maintenance Mode

- To scroll from one menu item to the next, press and release AIR. To reverse the scrolling direction:
 - a. Press and hold AIR.
 - b. Immediately press POWER/MODE and then release both buttons.
 - c. The scrolling direction returns to the original direction when you exit and reenter a menu.
- To skip an item when a question is asked, press and release AIR.
- To enter an item and to save any changes, press and release POWER MODE.
- To change a flashing parameter, use AIR. To reverse the direction of change (ie. from increasing to decreasing or vice versa):
 - a. Press and hold AIR.
 - b. Immediately press POWER MODE and then release both buttons.
- To exit an entered menu item without saving a change, press and hold AIR and POWER MODE for a few seconds.

Performing a Calibration (GAS CAL)

See “Performing a Calibration (GAS CAL)” on page 57 for instructions.

Performing a Gas Test (GAS TEST)

The **GAS TEST** menu item allows you to apply gas to the instrument and see all alarm indications except for the buzzer indication. There is no buzzer indication in the **GAS TEST** menu even though the buzzer will sound in the event of a real gas alarm condition while in Measuring Mode.

Preparing for a Gas Test

To perform a gas test on the GX-3R, you will need:

- A calibration cylinder. The concentrations should be above the alarm condition you want to check. Standard alarm points are listed on pg.8.
- 0.25 LPM fixed flow regulator
- Non-absorbent tubing

- Calibration cup
 1. Confirm that the regulator knob is turned all the way clockwise. Screw the 0.25 LPM fixed flow regulator onto the calibration cylinder.
 2. Install the calibration cup onto the GX-3R Pro. Use the label and imprinting to make sure that the calibration cup gets installed in the correct orientation relative to the GX-3R Pro. Be sure the calibration cup is pushed on all the way.

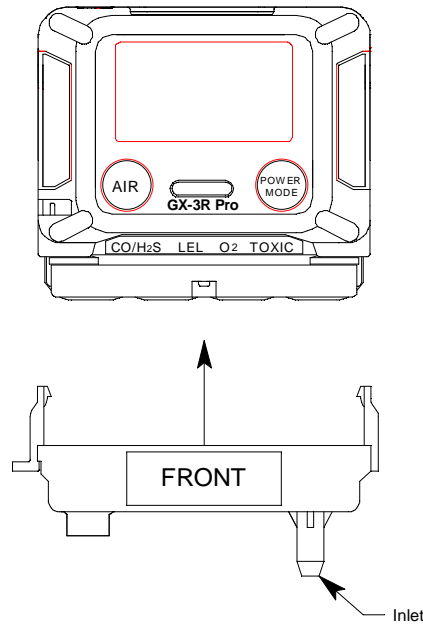

3. Use the tubing to connect the regulator to the inlet of the calibration cup.

Performing a Gas Test

1. While in Maintenance Mode, use AIR to place the cursor next to **GAS TEST**.

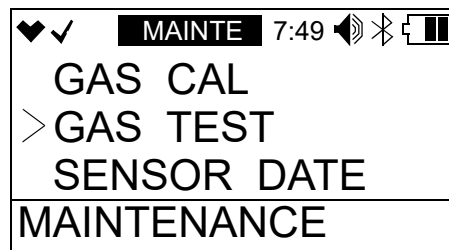

2. Press and release POWER MODE. The current gas readings display. The bottom of the LCD indicates "GAS TEST" and "BUZZER OFF".

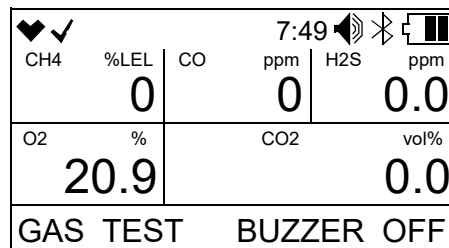

3. Turn the regulator knob counterclockwise to open the regulator.
4. The instrument will initiate alarm indications except for the buzzer. There is no buzzer indication in the **GAS TEST** menu even though the buzzer will sound in the event of a real gas alarm condition.

5. Turn the regulator knob clockwise to close the regulator.
6. Unscrew the regulator from the calibration cylinder.
7. Remove the calibration cup from the GX-3R.
8. Store the calibration kit in a safe and convenient place.
9. Press and release POWER MODE to return to Maintenance Mode.

Sensor/Battery Replacement Date (SENSOR DATE)

The **SEN DATE** menu item allows you to keep track of when the sensors and the battery were replaced.

1. While in Maintenance Mode, use AIR to place the cursor next to **SENSOR DATE**.

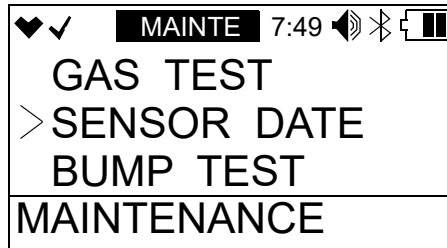

2. Press and release POWER MODE. The combustible gas sensor's replacement date will display.

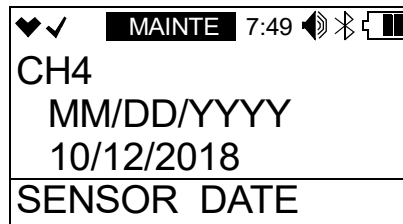

3. Use AIR to scroll to the item whose replacement date you want to view or change.

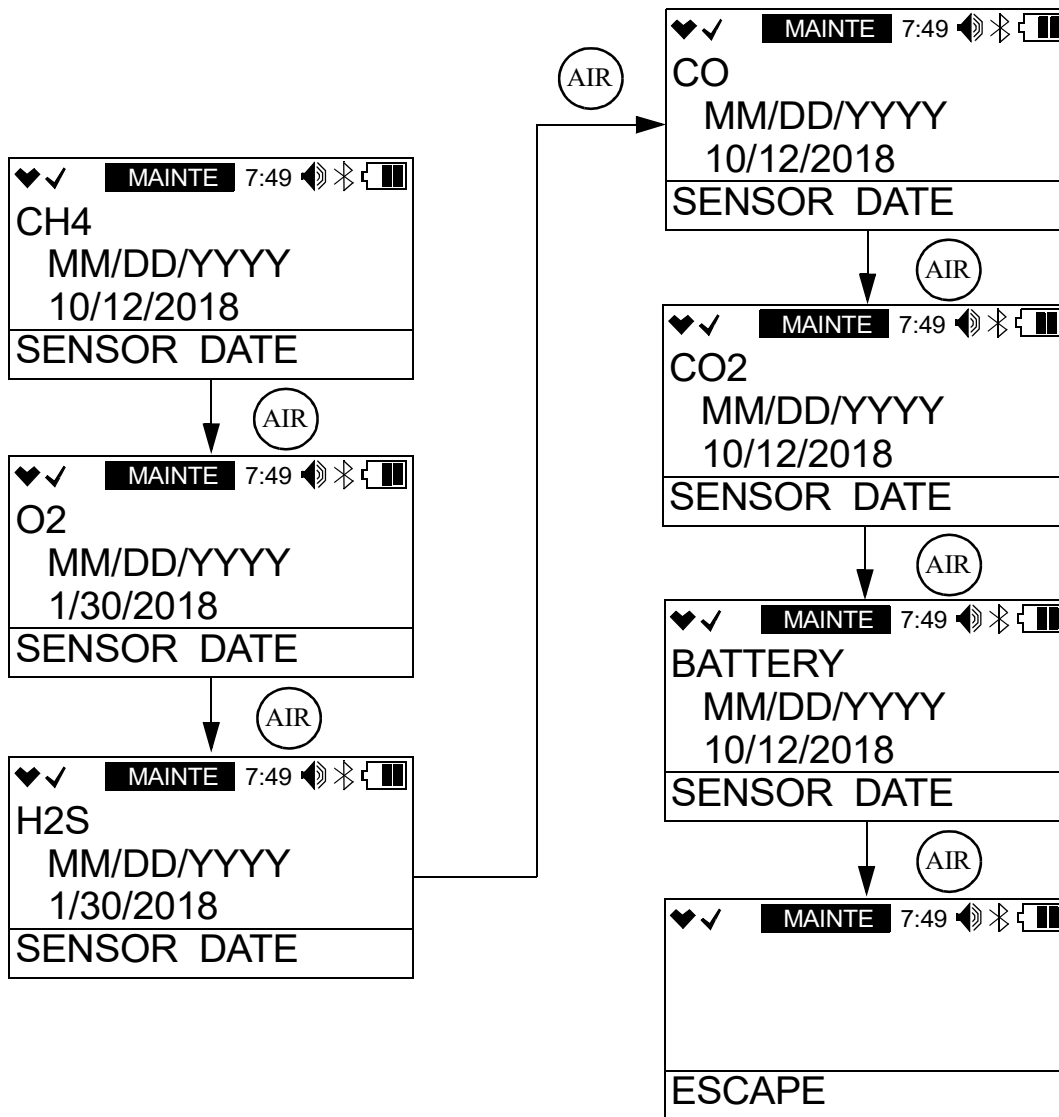

4. To change the replacement date:
 - a. With the desired item displayed, press and release POWER MODE.
 - b. Press and release POWER MODE again to set the replacement date to the current date.
5. Use the AIR button to scroll to the **ESCAPE** menu item.
6. Press and release POWER MODE to return to Maintenance Mode.

Performing a Bump Test (BUMP TEST)

See “Performing a Bump Test (BUMP TEST)” on page 53 for instructions.

Setting Alarms to Latching or Self-Resetting (LATCHING)

ON (factory setting): The GX-3R Pro remains in alarm until the alarm condition passes and POWER MODE is pressed.

OFF: The GX-3R Pro automatically resets an alarm when the alarm condition passes.

1. While in Maintenance Mode, use AIR to place the cursor next to **LATCHING**.



2. Press and release POWER MODE. The current setting flashes.
3. Use AIR to display the desired setting.
4. Press and release POWER MODE to save the setting and return to Maintenance Mode.

Turning Demand Zero On/Off (DEMAND ZERO)

ON (factory setting): You can manually perform a fresh air adjust in Measuring Mode by pressing AIR.

OFF: You cannot manually perform a fresh air adjust in Measuring Mode.

1. While in Maintenance Mode, use AIR to place the cursor next to **DEMAND ZERO**.



2. Press and release POWER MODE. The current setting flashes.
3. Use AIR to display the desired setting.
4. Press and release POWER MODE to save the setting and return to Maintenance Mode.

Turning Auto Zero On/Off (AUTO ZERO)

ON: The GX-3R Pro will ask if you want to perform a fresh air adjustment at the end of the startup sequence.

OFF (factory setting): The GX-3R Pro does not ask if you want to perform a fresh air adjustment at the end of the startup sequence.

1. While in Maintenance Mode, use AIR to place the cursor next to **AUTO ZERO**.



2. Press and release POWER MODE. The current setting flashes.
3. Use AIR to display the desired setting.
4. Press and release POWER MODE to save the setting and return to Maintenance Mode.

Turning ID Display Function On/Off (ID DISPLAY)

ON: The User ID and Station ID screens appear in startup sequence. If **D MODE SETTING** in User Mode is also set to **ON**, then the IDs can be changed in Display Mode.

OFF (factory setting): The User ID and Station ID screens do not appear in startup sequence and the IDs cannot be changed in Display Mode.

1. While in Maintenance Mode, use AIR to place the cursor next to **ID DISPLAY**.



2. Press and release POWER MODE. The current setting flashes.
3. Use AIR to display the desired setting.
4. Press and release POWER MODE to save the setting and return to Maintenance Mode.

Turning Zero Suppression On/Off (ZERO SUPPRESS)

The **ZERO SUPPRESS** setting is not intended for field adjustment. The default setting for each sensor is **ON**.

Sensor	Zero Suppression Value
Combustible Gas	2% LEL
O ₂	0.5% volume
H ₂ S	0.3 ppm
CO	2 ppm
CO ₂	0 ppm
SO ₂	0.20 ppm

Turning Zero Follower On/Off (ZERO FOLLOWER)

The **ZERO FOLLOWER** setting is not intended for field adjustment. The oxygen channel does not support zero follower functionality. The default setting is **ON** for all channels.

User Mode Zero Suppression (DISP ZERO SUP)

ON: Zero suppression menu item appears in User Mode.

OFF (factory setting): Zero suppression menu item does not appear in User Mode. Zero suppression menu item is always available in Maintenance Mode.

It is not normally necessary to have the zero suppression menu item appear in User Mode. Contact RKI Instruments before turning this setting on.

User Mode Zero Follower (DISP ZERO FLWR)

ON: Zero follower menu item appears in User Mode.

OFF (factory setting): Zero follower menu item does not appear in User Mode. Zero follower menu item is always available in Maintenance Mode.

It is not normally necessary to have the zero follower menu item appear in User Mode. Contact RKI Instruments before turning this setting on.

Setting the Date/Time (DATE)

1. While in Maintenance Mode, use AIR to place the cursor next to **DATE**.

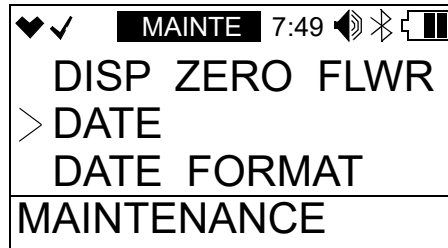

2. Press and release POWER MODE. The date and time will be displayed with the year flashing.

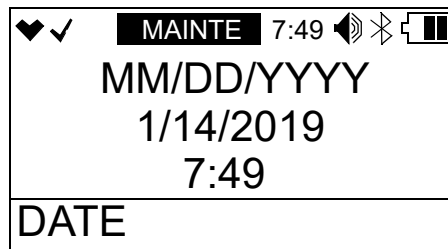

3. Use AIR to display the desired year.
4. Press and release POWER MODE to save the setting. The month setting flashes.
5. Repeat Step 3 and Step 4 to enter the month, day, hours, and minutes settings. The date and time will be saved and the instrument will return to Maintenance Mode.

Setting the Date Format (DATE FORMAT)

MM/DD/YYYY (factory setting): month/day/year.

YYYY/MM/DD: year, month, day.

DD/MM/YYYY: day, month, year.

1. While in Maintenance Mode, use AIR to place the cursor next to **DATE FORMAT**.



2. Press and release POWER MODE. The current setting flashes.
3. Use AIR to display the desired setting.
4. Press and release POWER MODE to save the setting and return to Maintenance Mode.

Setting the Instrument Language (LANGUAGE)

English (factory setting), Japanese, Italian, Spanish, German, French, Portuguese, Russian, Korean, Chinese (TC)

1. While in Maintenance Mode, use AIR to place the cursor next to **LANGUAGE**.



2. Press and release POWER MODE. The current setting flashes.
3. Use AIR to display the desired setting.
4. Press and release POWER MODE to save the setting and return to Maintenance Mode.

Turning the Password On/Off (MAINT PASSWORD)

ON (factory setting): The GX-3R Pro prompts you for a password when you enter Maintenance Mode. The factory-set password is **8102** but can be changed as desired.

OFF: No password is required to enter Maintenance Mode.

1. While in Maintenance Mode, use AIR to place the cursor next to **PASSWORD**.

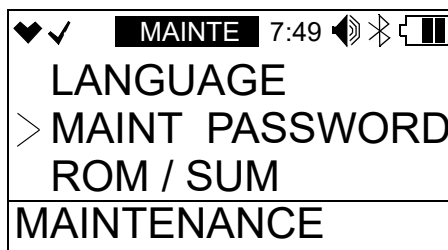

2. Press and release POWER MODE. The current setting flashes.
3. Use AIR to display the desired setting.
4. If you selected **OFF**, press and release POWER MODE to save the setting and return Maintenance Mode.

If you selected **ON**, continue with Step 5.

5. Press and release POWER MODE. The Set Password Screen appears. The current password is at the top of the screen with the first digit flashing.

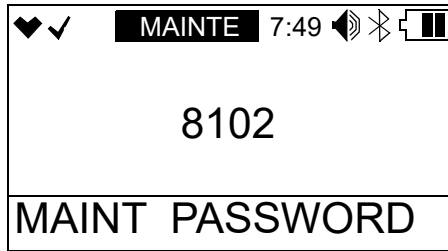

6. Use AIR to display a number from 0 to 9.
7. Press and release POWER MODE to enter the selection and advance to the next number. To go back a number, press and hold AIR and POWER MODE for a few seconds.
8. Repeat Step 6 and Step 7 to select the remaining numbers. When you press and release POWER MODE to enter the last number, the password is saved and the instrument returns to Maintenance Mode.

Viewing the ROM/SUM (ROM/SUM)

The **ROM/SUM** screen shows the firmware version that is loaded in the instrument and the firmware checksum.

1. While in Maintenance Mode, use AIR to place the cursor next to **ROM/SUM**.



2. Press and release POWER MODE. The screen will cycle through the ROM/SUM of the main board, the ROM/SUM of the sensor board, the ROM/SUM of the IR sensor (if an IR sensor is installed), and the Bluetooth version. The ROM is the top value and the SUM is the bottom value.

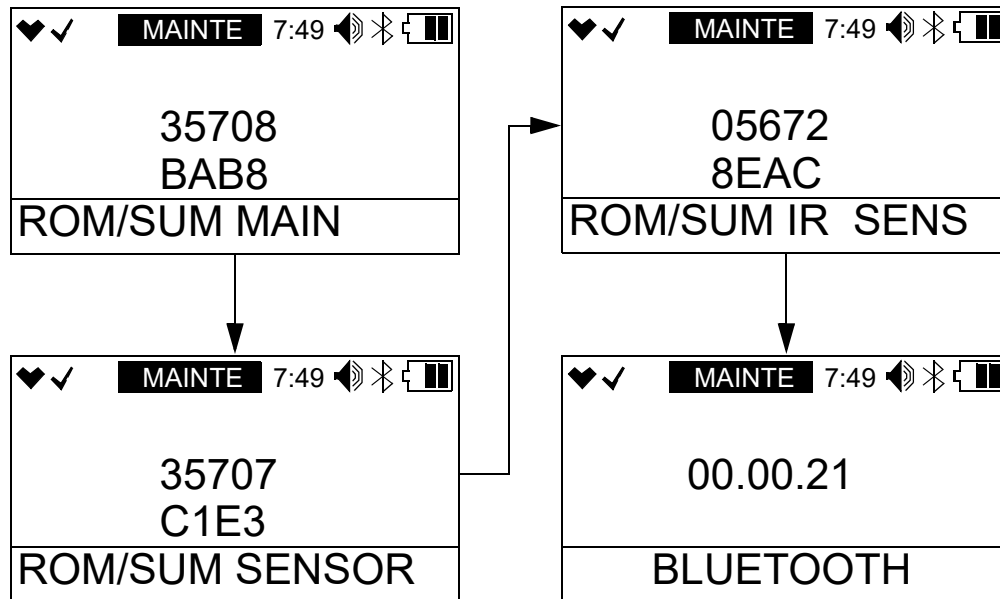

3. Press and release POWER MODE to return to the **ROM/SUM** menu item in Maintenance Mode.

Adjusting the LCD's Contrast (LCD CONTRAST)

Higher number means darker background. Lower number means lighter background. 1-50. 20 is factory setting.

1. While in Maintenance Mode, use AIR to place the cursor next to **LCD CONTRAST**.

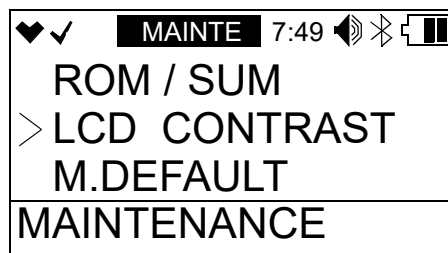

2. Press and release POWER MODE. The current setting flashes.
3. Use AIR to display the desired setting.
4. Press and release POWER MODE to save the setting and return to Maintenance Mode.

Performing a Default (M.DEFAULT)

Performing a default operation in Maintenance Mode returns all parameters to their RKI factory settings.

1. While in Maintenance Mode, use AIR to place the cursor next to **M.DEFAULT**.

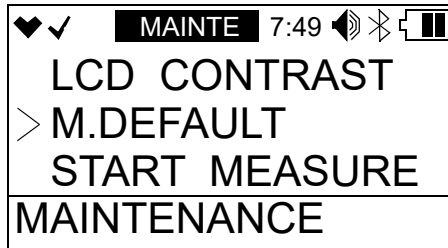

2. Press and release POWER MODE. The instrument asks if you want to restore all defaults.
3. Press and release POWER MODE to continue.
4. Press and release AIR to return to Maintenance Mode.
5. The instrument asks if you are sure you want to restore the defaults.
6. Press and release POWER MODE to continue. Press and release AIR to return to Maintenance Mode.
7. Once the defaults are restored, the instrument will return to Maintenance Mode.

Exiting Maintenance Mode (START MEASURE)

1. While in Maintenance Mode, use AIR to place the cursor next to **START MEASURE**.

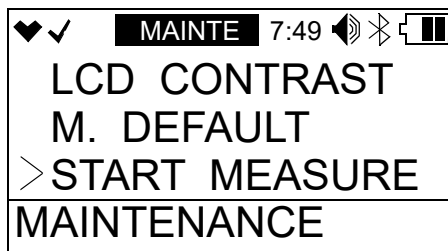

2. Press and release POWER MODE.
3. The instrument will begin its start-up sequence.

Appendix C: Gas Select Mode

Overview

This appendix describes the GX-3R Pro in Gas Select Mode. The GX-3R Pro is factory-set to suit most applications. Update settings in Gas Select Mode only if required for your specific application. A description of the Gas Select Mode items is shown in Table 19 below.

Table 19: Gas Select Mode Menu Items

Menu Item (Page # of Description)	Description
GAS COMBO (pg.148)	Turn channels on or off and changes target gas for each channel.
SET DEF ALM-P (pg.150)	Allows you to set the current alarm points as the default alarm points.
DISP MAX SPAN (pg.150)	ON : Maximum span screen appears after a successful calibration. OFF (factory setting) : No maximum span screen appears.
STEALTH (pg.151)	STEALTH ON : No backlight, LED, or buzzer operation. STEALTH OFF (factory setting) : Backlight, LED, and buzzer operate normally.
	<i>This setting has no effect unless STEALTH is set to ON.</i> VIBRATION ON : Vibrator activates for alarm conditions. VIBRATION OFF (factory setting) : Vibrator does not activate in any situation.
CHANGE LEL (pg.152)	STANDARD (factory setting) : Apply standard settings for lower explosive limit's ppm level. IEC : Apply IEC settings for lower explosive limit's ppm level. ISO : Apply ISO settings for lower explosive limit's ppm level.
START MEASURE (pg.153)	Enter Measuring Mode

Entering Gas Select Mode

WARNING: *The GX-3R Pro is not in operation as a gas detector while in Gas Select Mode.*

1. Take the GX-3R Pro to a non-hazardous location and turn it off if it is on.
2. Press and hold AIR, then press and hold POWER MODE. You will hear a beep after one second. Continue to hold the buttons down.
3. You will hear a second beep. Continue to hold the buttons down.
4. When you hear a third beep, release the buttons.

5. The password screen will appear. The first digit will be flashing. The password is **2014**.



6. Use AIR to select each password number then press POWER MODE to save it and move on to the next number. To go back a number, press and hold AIR and POWER MODE for a few seconds. To reverse the direction of change (ie. from increasing to decreasing or vice versa):
- Press and hold AIR.
 - Immediately press POWER MODE and then release both buttons.
7. The Gas Select Mode menu displays.



8. Use AIR to move through the Gas Select Mode menu items.

Tips for Using Gas Select Mode

- To scroll from one menu item to the next, press and release AIR. To reverse the scrolling direction:
 - Press and hold AIR.
 - Immediately press POWER/MODE and then release both buttons.
 - The scrolling direction returns to the original direction when you exit and reenter a menu.
- To skip an item when a question is asked, press and release AIR.
- To enter an item and to save any changes, press and release POWER MODE.
- To change a flashing parameter, use AIR. To reverse the direction of change (ie. from increasing to decreasing or vice versa):
 - Press and hold AIR.
 - Immediately press POWER MODE and then release both buttons.
- To exit an entered menu item without saving a change, press and hold AIR and POWER MODE for a few seconds.

Changing the Gas Combination (GAS COMBO)

The **GAS COMBO** menu item allows you to turn channels on and off.

1. While in Gas Select Mode, use **AIR** to place the cursor next to **GAS COMBO**.



2. Press and release **POWER MODE**. The first channel is displayed.

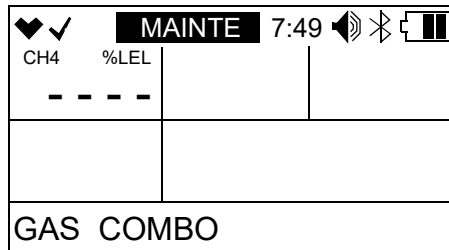

3. Press **AIR** to scroll through to the instrument channel whose target gas you want to change.

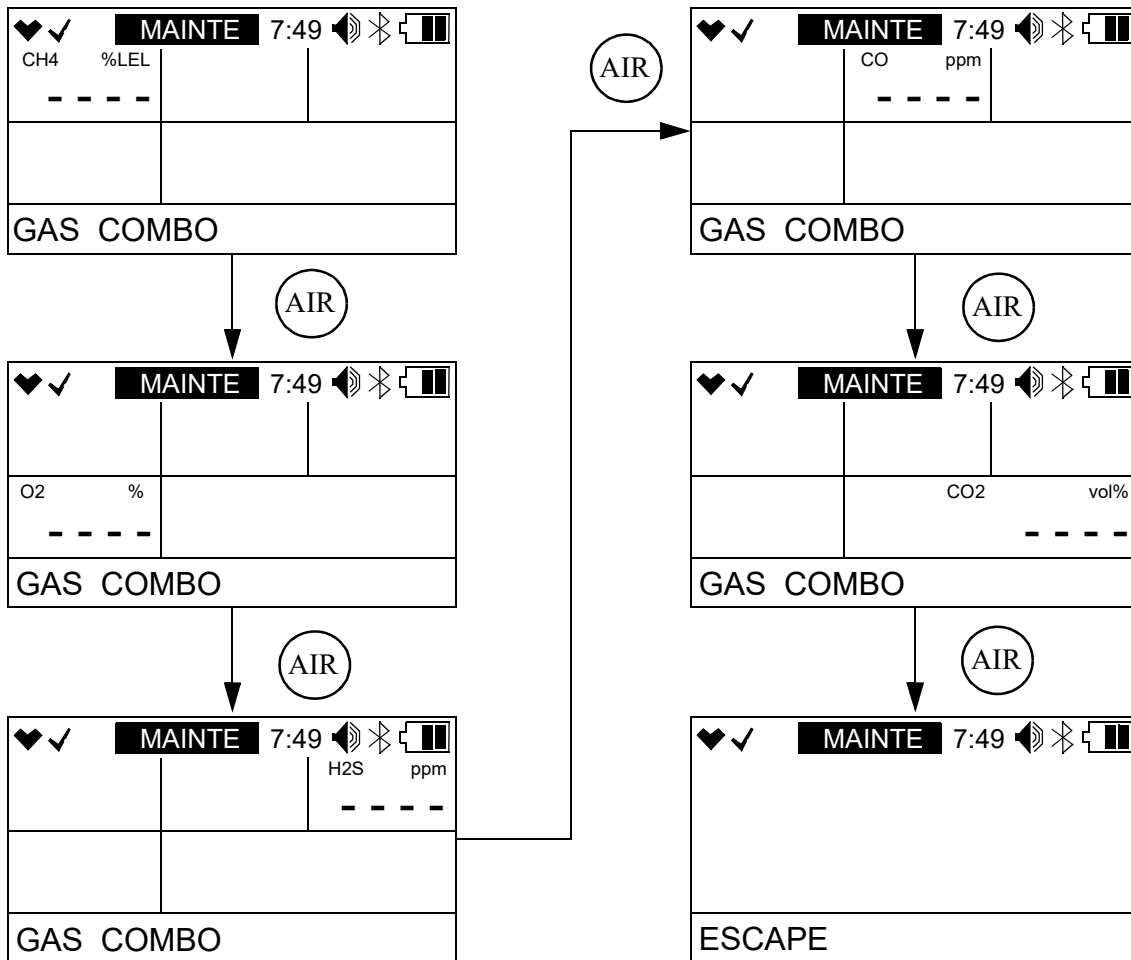

4. Press and release POWER MODE.
5. The target gas for the channel will display.



6. Use AIR to change the target gas or turn the channel off.

Table 20: Target Gas Options for Each Channel

Channel	Target Gas Options
Combustible Gas	<ul style="list-style-type: none"> • CH4 (methane) • i-C4H10 (isobutane) • H2 (hydrogen) • CH3OH (methanol) • C2H2 (acetylene) • C2H4 (ethylene) • C2H6 (ethane) • C2H5OH (ethanol) • C3H6 (propylene) • C3H6O (acetone) • C3H8 (propane) • C4H6 (butyne) • C5H10 (cyclopentane) • C6H6 (benzene) • n-C6H14 (hexane) • C7H8 (toluene) • n-C7H16 (heptane) • C8H10 (xylene) • n-C9H20 (nonane) • EtAc (ethyl acetate) • IPA (isopropyl alcohol) • MEK (methyl ethyl ketone) • MMA (methyl methacrylate) • DME (dimethyl ether) • MIBK (methyl isobutyl ketone) • THF (tetrahydrofuran) • CH4_VOL (methane %volume)* • ----- (off)
O2	<ul style="list-style-type: none"> • O2 (oxygen) • ----- (off)
H2S	<ul style="list-style-type: none"> • H2S (hydrogen sulfide for dual CO/H₂S sensor) • H2S SINGLE (hydrogen sulfide for single-gas H₂S sensor) • H₂_CO-H₂ (hydrogen compensated CO) • ----- (off)
CO	<ul style="list-style-type: none"> • CO (carbon dioxide for dual CO/H₂S sensor or single-gas CO sensor) • SO2 (sulfur dioxide) • CO_CO-H₂ (hydrogen compensated CO) • ----- (off)
5th gas	<ul style="list-style-type: none"> • EXTRA (for CO₂ sensors) • SO2 (sulfur dioxide) • H2S (hydrogen sulfide for single-gas H₂S sensor) • ----- (off)
<p><i>* If CH4_VOL is selected, the CHANGE LEL item in Gas Select Mode has no effect on operation.</i></p>	

7. Press and release POWER MODE to save the setting.
8. Repeat Step 1 - Step 7 to change the target gas for other channels.

9. Use AIR to scroll to **ESCAPE**.
10. Press and release POWER MODE. The instrument will return to Gas Select Mode.

Saving the Alarm Points (SET DEF ALM-P)

Performing a **SET DEF ALM-P** operation saves the current alarm setpoints.

Performing a **DEFAULT ALM-P** operation in the **ALARM SETTING** User Mode menu item sets the instrument's alarm points to those saved during the **SET DEF ALM-P** operation (if performed).

Performing a **SET DEF ALM-P** operation has no effect on an **M.DEFAULT** in Maintenance Mode. An **M.DEFAULT** operation will return all instrument settings to the RKI default regardless of if a **SET DEF ALM-P** operation was performed.

1. While in Gas Select Mode, use AIR to place the cursor next to **SET DEF ALM-P**.



2. Press and release POWER MODE. The display alternate between the following screens.

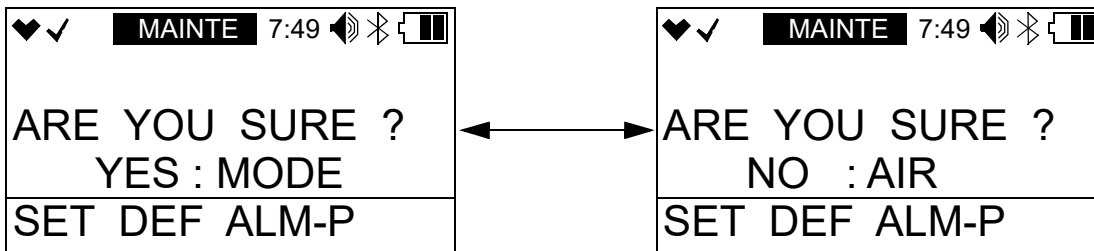

3. Press and release POWER MODE to save the current alarm point settings as the default.
4. The instrument will return to Gas Select Mode.

Turning the Calibration Max Span On/Off (DISP MAX SPAN)

ON: After a passed calibration, the GX-3R displays the maximum possible adjustment it could have made to the response reading. So if the combustible gas channel was calibrated with 50% LEL gas and the maximum indicated span is 95% LEL, this means that there was enough adjustment left on that channel to set the reading to 95% LEL when the detector was exposed to 50% LEL gas. If the maximum span value is close to the calibration gas value, for example if it is 53% LEL when exposed to 50% LEL gas, the sensor should be replaced soon. The upper limit on the maximum adjustment indicated for all channels except for oxygen is either twice the calibration value or full scale, whichever is lower. The upper limit on the maximum adjustment indicated for the oxygen channel is 25.0% volume.

OFF (factory setting): There is no maximum span indication at the end of a calibration.

1. While in Gas Select Mode, use AIR to place the cursor next to **DISP MAX SPAN**.



2. Press and release POWER MODE. The current setting flashes.
3. Use AIR to display the desired setting.
4. Press and release POWER MODE to save the setting and return to Gas Select Mode.

Stealth and Vibrator Settings (STEALTH)

STEALTH

ON:

- The instrument's backlight does not come on, regardless of the **BACKLIGHT TIME** setting.
- The instrument's LEDs do not come on for any reason, even alarm conditions.
- The instrument's buzzer does not sound for any reason, even alarm conditions.
- An "S" appears at the top of the LCD.

OFF (factory setting): The instrument's backlight and LEDs operate normally.

VIBRATION

The VIBRATION setting only affects instrument operation if STEALTH is set to ON.

ON: The vibrator activates for alarm conditions. It can be useful to have this feature turned on if you have also turned **STEALTH** on.

OFF (factory setting): The vibrator does not activate for any reason.

1. While in Gas Select Mode, use AIR to place the cursor next to **DISP MAX SPAN**.



2. Press and release POWER MODE. The current setting flashes.
3. Press and release POWER MODE. The current **STEALTH** setting flashes.
4. Use AIR to display the desired setting.
5. Press and release POWER MODE. The current **VIBRATION** setting flashes.
6. Use AIR to display the desired setting.
7. Press and release POWER MODE to save the setting and return to Gas Select Mode.

LEL Definition (CHANGE LEL)

The **CHANGE LEL** menu item defines what standard the instrument follows in determining the LEL (lower explosive limit) for the combustible channel's target gas.

STANDARD: Apply the standards settings for the lower explosive limit's ppm level.

IEC: Apply the IEC settings for the lower explosive limit's ppm level.

ISO: Apply the ISO settings for the lower explosive limit's ppm level.

Table 21: Lower Explosive Limit ppm Levels

Gas	Standard (ppm)	IEC (ppm)	ISO (ppm)
Methane (CH ₄)	50,000	44,000	44,000
Isobutane (i-C ₄ H ₁₀)	18,000	13,000	15,000
Hydrogen (H ₂)	40,000	40,000	40,000
Methanol (CH ₃ OH)	55,000	60,000	60,000
Acetylene (C ₂ H ₂)	15,000	23,000	23,000
Ethylene (C ₂ H ₄)	27,000	23,000	24,000
Ethane (C ₂ H ₆)	30,000	24,000	24,000
Ethanol (C ₂ H ₅ OH)	33,000	31,000	31,000
Propylene (C ₃ H ₆)	20,000	20,000	18,000
Acetone (C ₃ H ₆ O)	21,500	25,000	25,000
Propane (C ₃ H ₈)	20,000	17,000	17,000
Butadiene (C ₄ H ₆)	11,000	14,000	14,000
Cyclopentane (C ₅ H ₁₀)	14,000	14,000	14,000
Benzene (C ₆ H ₆)	12,000	12,000	12,000
N-hexane (n-C ₆ H ₁₄)	12,000	10,000	10,000
Toluene (C ₇ H ₈)	12,000	10,000	10,000
N-heptane (n-C ₇ H ₁₆)	11,000	8,500	8,000
Xylene (C ₈ H ₁₀)	10,000	10,000	10,000
N-nonane (n-C ₉ H ₂₀)	7,000	7,000	7,000
Ethyl acetate (EtAc)	21,000	20,000	20,000
Isopropyl alcohol (IPA)	20,000	20,000	20,000
Methyl ethyl ketone (MEK)	18,000	15,000	15,000
Methyl methacrylate (MMA)	17,000	17,000	17,000
Dimethyl ether (DME)	30,000	27,000	27,000
Methyl isobutyl ketone (MIBK)	12,000	12,000	12,000

Table 21: Lower Explosive Limit ppm Levels

Gas	Standard (ppm)	IEC (ppm)	ISO (ppm)
Tetrahydrofuran (THK)	20,000	15,000	15,000

1. While in Gas Select Mode, use AIR to place the cursor next to **CHANGE LEL**.

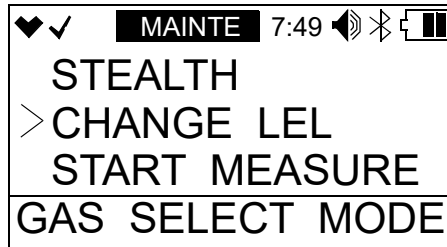

2. Press and release POWER MODE. The current setting flashes.
3. Use AIR to display the desired setting.
4. Press and release POWER MODE to save the setting and return to Gas Select Mode.

Exiting Gas Select Mode (START MEASURE)

1. From the main menu, place the cursor in front of **START MEASURE** at the bottom of the menu.

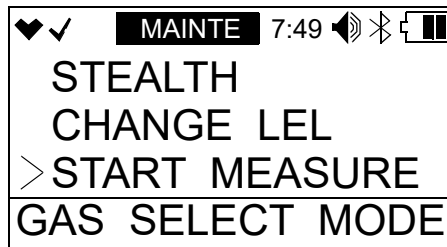

2. Press and release POWER MODE.
3. The unit will begin its start-up sequence.

Warranty

RKI Instruments, Inc. warrants the GX-3R Pro sold by us to be free from defects in materials, workmanship, and performance for a period of three years from the date of shipment from RKI Instruments, Inc. This includes the instrument and the original sensors. Replacement parts are warranted for 1 year from the date of their shipment from RKI Instruments, Inc. except for replacement sensors which are warranted for 3 years. Any parts found defective within their warranty period will be repaired or replaced, at our option, free of charge. This warranty does not apply to those items which by their nature are subject to deterioration or consumption in normal service, and which must be cleaned, repaired, or replaced on a routine basis. Examples of such items are:

Absorbent cartridges

Filter elements, disks, or sheets

Pump diaphragms and valves

Warranty is voided by abuse including mechanical damage, alteration, rough handling, or repair procedures not in accordance with the instruction manual. This warranty indicates the full extent of our liability, and we are not responsible for removal or replacement costs, local repair costs, transportation costs, or contingent expenses incurred without our prior approval.

THIS WARRANTY IS EXPRESSLY IN LIEU OF ANY AND ALL OTHER WARRANTIES AND REPRESENTATIONS, EXPRESSED OR IMPLIED, AND ALL OTHER OBLIGATIONS OR LIABILITIES ON THE PART OF RKI INSTRUMENTS, INC. INCLUDING BUT NOT LIMITED TO THE WARRANTY OF MERCHANTABILITY OR FITNESS FOR A PARTICULAR PURPOSE. IN NO EVENT SHALL RKI INSTRUMENTS, INC. BE LIABLE FOR INDIRECT, INCIDENTAL, OR CONSEQUENTIAL LOSS OR DAMAGE OF ANY KIND CONNECTED WITH THE USE OF ITS PRODUCTS OR FAILURE OF ITS PRODUCTS TO FUNCTION OR OPERATE PROPERLY.

This warranty covers instruments and parts sold to users only by authorized distributors, dealers, and representatives as appointed by RKI Instruments, Inc.

We do not assume indemnification for any accident or damage caused by the operation of this gas monitor and our warranty is limited to replacement of parts or our complete goods.