

# FA-200 Alarm Bar

## User's Guide





# FA-200 Alarm Bar User's Guide

## Contents

	Warnings.....	3
1	Standard Contents.....	4
2	General Information .....	4
2.1	Key Features.....	4
3	Physical Description.....	5
4	Installation .....	5
4.1	Mounting the FA-200 Alarm Bar .....	5
4.2	Drilling Chart.....	6
4.3	Electrical/Control Connections .....	6
4.4	Connecting to An FMC2000 Controller.....	7
4.5	Positioning The Siren Horn .....	8
5	Maintenance .....	8
6	Specifications .....	9
	Special Servicing Note .....	10
7	Troubleshooting.....	11
7.1	Checking FMC2000 Relay Continuity.....	12
8	Technical Support.....	15
9	RAE Systems Contacts.....	16

## **FA-200 Alarm Bar User's Guide**

### **Read Before Operating**

This manual must be carefully read by all individuals who have or will have the responsibility of using, maintaining, or servicing this product. The product will perform as designed only if it is used, maintained, and serviced in accordance with the manufacturer's instructions. The user should understand how to set the correct parameters and interpret the obtained results.

#### **CAUTION!**

To reduce the risk of electric shock, turn the power off before opening this instrument or performing service. Never operate the instrument when the instrument is open. Use and service this product only in an area known to be non-hazardous.

## FA-200 Alarm Bar User's Guide

### **WARNINGS**

Use only in non-hazardous locations.

For safety reasons, this equipment must be operated and serviced by qualified personnel only. Read and understand instruction manual completely before operating or servicing.

### **AVERTISSEMENT**

Utiliser uniquement en zone non-dangereuse.

Pour des raisons de sécurité, cet équipement doit être utilisé, entretenu et réparé uniquement par un personnel qualifié. Étudier le manuel d'instructions en entier avant d'utiliser, d'entretenir ou de réparer l'équipement.

# FA-200 Alarm Bar User's Guide

## 1 Standard Contents

- FA-200 Alarm Bar
- Integral 10-meter (33-foot) connection cable
- User's Guide

## 2 General Information

The FA-200 Alarm Bar works with RAE Systems FMC2000 controller and other compatible devices. It provides bright visible and loud audible notification when a controller is in alarm.

### 2.1 Key Features

- Loud siren: 112dB @ 3 m (10')
- Four bright strobe lights with impact-resistant polycarbonate lenses (red, white, blue, amber)
- Heavy-duty stainless-steel enclosure
- Stainless-steel bars to protect strobe lights
- Second port for interconnection with second controller
- Low maintenance

## **FA-200 Alarm Bar User's Guide**

### **3 Physical Description**

The FA-200 Alarm Bar comes pre-assembled and requires only connection via its integrated cord to a controller with relays. It has mounting flanges at the top and bottom with four holes that accept screws for attaching the FA-200 Alarm Bar to a wall or other flat surface. It receives all power from the controller that it is attached to, simplifying installation and maintenance.

### **4 Installation**

#### **4.1 Mounting the FA-200 Alarm Bar**

The FA-200 Alarm Bar is designed to be wall-mounted and has four holes for anchoring the FA-200 Alarm Bar, using screws or bolts.

Before mounting the FA-200 Alarm Bar, make sure that its cord can reach the controller that it will be electrically connected to.

Make sure that there is approximately 12" (30 cm) of clearance on all sides of the FA-200 Alarm Bar so that the siren's sound is not attenuated and to ensure clear view of the four visible alarm lights.

Follow these steps:

1. Locate the FA-200 Alarm Bar on a wall or other flat surface and mark the four holes' locations.
2. Remove the FA-200 Alarm Bar.
3. Drill the four holes.

# FA-200 Alarm Bar User's Guide

4. Hold the FA-200 Alarm Bar firmly against the wall and insert and tighten the screws.

The FA-200 Alarm Bar is now ready to be connected to the controller.

## 4.2 Drilling Chart

When mounting the FMC2000 on a wall, make sure to use heavy-duty steel screws spaced as indicated below.

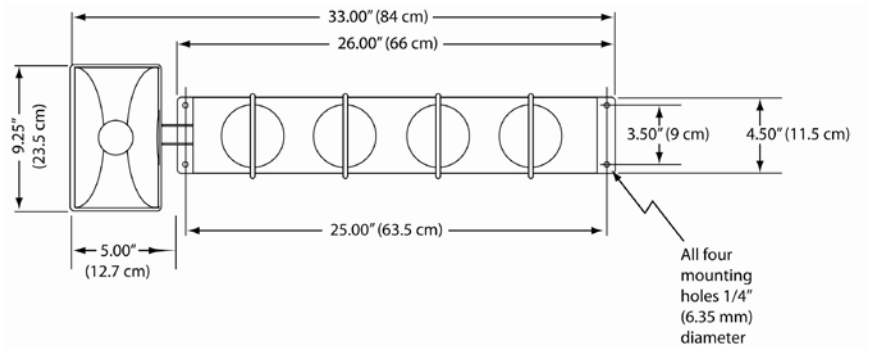

## 4.3 Electrical/Control Connections

The FA-200 Alarm Bar has a 33' (10 m) cable with a screw-type multi-pin connector. It is designed to mate with the connector on a RAE Systems FMC2000 controller and some similar controllers that use the same connector type and relay configuration.



## FA-200 Alarm Bar User's Guide

### 4.4 Connecting to An FMC2000 Controller

The FMC2000 has a female 6-pin connector on the bottom that is designed for connection with a RAE Systems FA-200 Alarm Bar.

**Note:** The internal wires from the FMC2000 connector are pre-wired to the NO (Normally Open) connection points on the five relay wiring blocks. Refer to the FMC2000 User's Guide for details of wiring for other configurations, including NC (normally closed) and other alarm orders.

**Note:** Pin F connects to Ground. Pins B, C, D, and E transmit 12V @ 2A power when an alarm occurs.

#### FMC2000 Connector Pin Layout

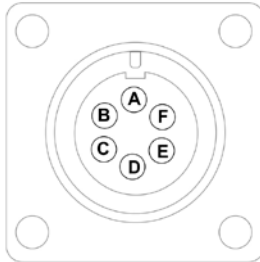

**FMC2000 Connector Pinout**

**Pin A:** No connection

**Pin B:** Power switch for red light

**Pin C:** Power switch for blue light

**Pin D:** Power switch for amber light

**Pin E:** Power switch for white light

**Pin F:** Ground

**Note:** If a second controller is not connected to the auxiliary port on the FA-200 Alarm Bar, keep the dust cap on the connector to protect the pins.

## **FA-200 Alarm Bar User's Guide**

### **4.5 Positioning The Siren Horn**

If the FA-200 Alarm Bar is to be used outdoors or in other environments where it may become wet, point the horn slightly downward to allow drainage. This will prolong its life and ensure its effectiveness.

## **5 Maintenance**

No periodic maintenance is required for the FA-200 Alarm Bar. Check occasionally that the cable is securely fastened and shows no sign of damage. Also check that the polycarbonate lenses are tightened on the bases of the strobe lights and have no cracks. If they are damaged, they should be replaced.

## FA-200 Alarm Bar User's Guide

### 6 Specifications

<b>Size</b>	8" x 33" x 4.5" (20.3 cm x 84 cm x 11.5 cm), including siren horn
<b>Weight</b>	14.5 lbs (6.6 kg), excluding cable
<b>Enclosure material</b>	Stainless steel with stainless steel protection bars over each strobe light
<b>Audible alarm</b>	112dB @ 3 m (10')
<b>Visual alarms</b>	Four super-bright xenon strobe lights with polycarbonate lens covers (red, white, blue, amber)
<b>Flash rate</b>	1 flash per second
<b>Primary Input</b>	Permanently affixed cable with 6-pin male connector
<b>Secondary Input</b>	6-pin male connector
<b>Cable Length</b>	33' (10 m)
<b>Power Supply</b>	Powered by 12-volt 2A outputs from controller
<b>Operating Temperature</b>	-40° F to +131° F (-40° C to +55° C)

## **FA-200 Alarm Bar User's Guide**

### **Special Servicing Note**

If the instrument needs to be serviced, contact either:

The RAE Systems distributor from whom the instrument was purchased; they will return the instrument on your behalf.

or

The RAE Systems Technical Service Department. Before returning the instrument for service or repair, obtain a Returned Material Authorization (RMA) number for proper tracking of your equipment. This number needs to be on all documentation and posted on the outside of the box in which the instrument is returned for service or upgrade. Packages without RMA Numbers will be refused at the factory.

## 7 Troubleshooting

Problem	Possible Reasons & Solutions
Siren inoperative	<p><b>Reasons:</b> Wiring problem. Alarm level set too low at controller.</p> <p><b>Solutions:</b> Make sure cable is connected to controller. Make sure cable is not damaged. Check siren horn for obstruction. Test relay in controller.</p>
Strobe light inoperative	<p><b>Reasons:</b> Wiring problem. Alarm level set too low at controller. Strobe light is damaged.</p> <p><b>Solutions:</b> Make sure cable is connected to controller. Make sure cable is not damaged. Check siren horn for obstruction. Test relay in controller. Call Technical Support at +1 408-752-0723 or toll-free at +1 888-723-4800</p>
Wrong strobe light during alarm	<p><b>Reasons:</b> Relay wiring problem.</p> <p><b>Reasons:</b> Check that correct relay is wired to appropriate strobe light.</p>

# FA-200 Alarm Bar User's Guide

## 7.1 Checking FMC2000 Relay Continuity

Each relay in an FMC2000 controller has a common terminal and a normally open (NO) and normally closed (NC) terminal. If you think the wiring to the FA-200 Alarm Bar is correct and that the FA-200 Alarm Bar is in working order, but that an alarm signal is not being passed to it, check the relays in the FMC2000 controller. Use a continuity tester or voltmeter (set to measure resistance) to check the relay's activity.

1. Enter the Relay Diagnostic menu. Press Enter, followed by the password (the default is 123456).

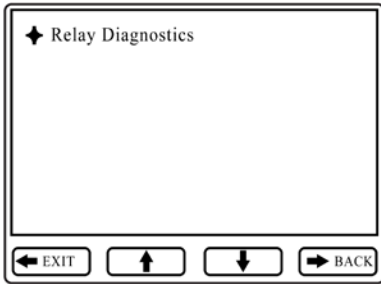

2. Touch the probes of a continuity tester or voltmeter to the NO and COM terminals on the relay's relay block inside the FMC2000.

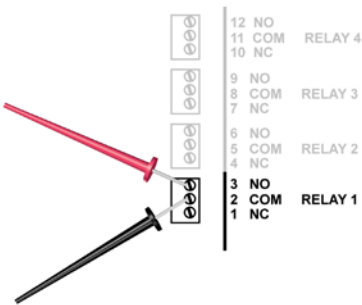

Testing continuity of Normally Open portion of relay.

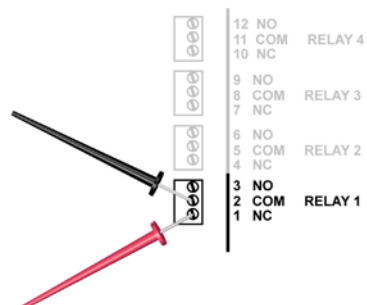

Testing continuity of Normally Closed portion of relay.

## FA-200 Alarm Bar User's Guide

3. In the Relay Diagnostic menu, toggle the relay by pressing the keypad's corresponding key (1, 2, 3, 4, 5).

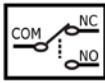

Relay1

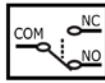

Relay1



Relay1



4. Touch the probes to the NC and COM terminals on the relay block.
5. Again, toggle the relay by pressing the corresponding key on the keypad.

Each time you press the key, the continuity tester or voltmeter should show that the relay has changed from open to closed (or vice versa). If this change does not occur, then the relay may be damaged and require replacement. Contact RAE Systems Customer Support.

## FA-200 Alarm Bar User's Guide

**Note:** Make sure the jumpers (marked JP for each of the five relays) are in place on the printed circuit board that includes the five alarm relay connection blocks in the FMC2000. If any of the jumpers is missing, the relay is in “dry contact” configuration, and no voltage reaches the relay connection blocks.

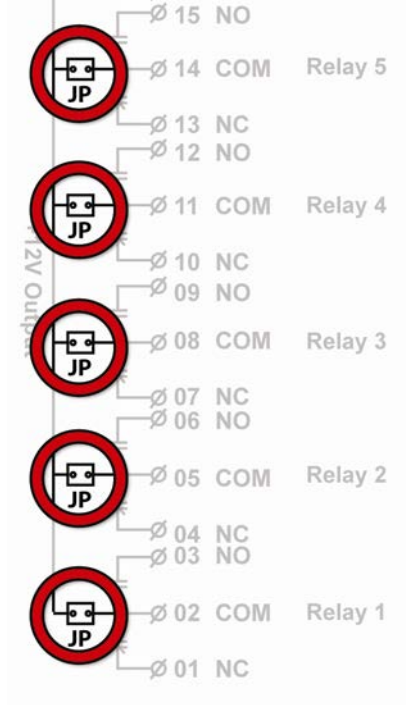
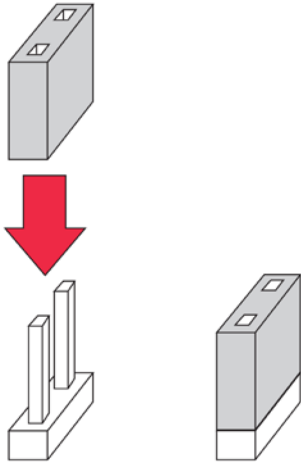



## **8 Technical Support**

To contact RAE Systems Technical Support Team:

Monday through Friday, 7:00AM to 5:00PM Pacific (US) Time

Phone (toll-free): +1 888-723-4800

Phone: +1 408-952-8461

Email: [tech@raesystems.com](mailto:tech@raesystems.com)

## **9 RAE Systems Contacts**

### **RAE Systems by Honeywell**

#### **World Headquarters**

3775 N. First St.

San Jose, CA 95134-1708 USA

Phone: +1 408.952.8200

Fax: +1 408.952.8480

**E-mail:** [customerserv@raesystems.com](mailto:customerserv@raesystems.com)

**Web Site:** [www.raesystems.com](http://www.raesystems.com)

### **RAE Systems Technical Support**

Monday through Friday, 7:00AM to 5:00PM Pacific Time

Phone: +1.408.952.8461

Email: [tech@raesystems.com](mailto:tech@raesystems.com)

### **RAE Systems Europe ApS**

Kirstinehøj 23 A

DK-2770 Kastrup

Denmark

**Phone:** +45 86 52 51 55

**Fax:** +45 86 52 51 77

[orders@raeeurope.com](mailto:orders@raeeurope.com)

[sales@raeeurope.com](mailto:sales@raeeurope.com)

[service@raesystems.com](mailto:service@raesystems.com)

**Web:** [www.raesystems.eu](http://www.raesystems.eu)

## **FA-200 Alarm Bar User's Guide**

### **RAE Systems UK Ltd**

D5 Culham Innovation Centre  
Culham Science Centre  
Abingdon, Oxon OX14 3DB  
United Kingdom

**Phone:** +44 1865408368

**Fax:** +44 1235531119

**Mobile:** +44 7841362693

**Email:** raeuk@raeeurope.com

### **RAE Systems France**

336, rue de la fée des eaux  
69390 Vernaison  
France

**Phone:** +33 4 78 46 16 65

**Fax:** +33 4 78 46 25 98

**Email:** info-france@raeeurope.com

**Web:** www.raesystems.fr

### **RAE BeNeLux BV**

Rijndal 20  
2904 DC Capelle a/d IJssel

**Phone:** +31 10 4426149

**Fax:** +31 10 4426148

**Email:** info@rae.nl

**Web:** www.rae.nl

## **FA-200 Alarm Bar User's Guide**

### **RAE Systems Spain, s.l.**

Av. Remolar, 31  
08820 El Prat de Llobregat  
Spain

**Phone:** +34 933 788 352

**Fax:** +34 933 788 353

**Mobile:** +34 687 491 106

**Email:** spainsales@raesystems.com

**Web:** www.raespain.com

### **RAE Systems Middle East**

LOB 7, Ground Floor, Office 19  
Jebel Ali Free Zone  
Dubai, United Arab Emirates

**Phone:** +971.4.887.5562

**Fax:** +971.4.887.5563

### **RAE Systems (Hong Kong) Ltd.**

Units 1516-18, 15/F, Delta House, 3 On Yiu Street  
Shatin, NT, Hong Kong

**Phone:** +852.9.133.6225

**Fax:** +852.2.669.0803

**Email:** hksales@raesystems.com

### **RAE Systems Japan**

1-20-19-608 Higashinakajima Higashiyodogawa-ku  
Osaka 533-0033, Japan

**Phone:** +81.6.6325.7660

**Fax:** +81.6.6325.7662

**Email:** jpsales@raesystems.com

## **FA-200 Alarm Bar User's Guide**

### **RAE Systems Korea**

101-1301, Bucheon TechnoPark III, SamJungDong 36-1,  
Oh Jung-Gu, Bucheon-Si, Gyeong Gi-Do  
Korea 421-741

**Phone:** +82.32.624.0460

**Fax:** +82.32.624.0463

**Email:** [krsales@raesystems.com](mailto:krsales@raesystems.com)



**RAE Systems by Honeywell  
World Headquarters**

3775 N. First St.  
San Jose, CA 95134-1708 USA  
Phone: 408.952.8200  
Fax: 408.952.8480

**E-mail:** [customerserv@raesystems.com](mailto:customerserv@raesystems.com)

**Web Site:** [www.raesystems.com](http://www.raesystems.com)

Rev. A  
October 2009  
P/N F05-4030-000