

MeshGuard LEL IR MeshGuard CO2 IR User's Guide



Contents

1	Proper Product Disposal At End Of Life	6
2	Standard Kit	7
3	General Information.....	7
4	Physical Description	9
	4.1 LCD Display	10
	4.2 Specifications.....	11
5	Operating The Instrument.....	13
	5.1 Turning The Instrument On	13
	5.2 Turning The Instrument Off.....	14
	5.3 Low Battery Indicator & Action	15
	5.4 Over Range Alarm	15
	5.5 Wireless Communication Indicator	16
	5.6 Operation Modes.....	17
	5.7 Detection Mode.....	19
	5.8 Manually Sending Data.....	20
	5.9 Programming Mode	21
	5.9.1 Entering Programming Mode	22
	5.9.2 Exiting Programming Mode	23
	5.9.7 Change SPAN value	30
	5.9.8 Change Pan ID	31
	5.9.9 Join Mesh Network	31
	5.9.10 Change Communication Interval	31
6	Diagnostic Mode.....	33
	6.1 Entering Diagnostic Mode	33
	6.2 Exiting Diagnostic Mode	34
	6.3 Diagnostic Mode Readings	34
	6.3.1 Sensor Raw Count.....	34
	6.3.2 Battery Raw Count.....	34
	6.3.3 Temperature Raw Count	34
	6.3.4 Zero Raw Count.....	35
	6.3.5 Calibration Delta Counts.....	35
	6.3.6 Radio Type.....	35
	6.3.7 Radio Module Firmware Version	35

MeshGuard LEL IR & MeshGuard CO₂ IR User's Guide

6.4	Diagnostic Mode Programming.....	36
6.4.1	Radio Enable/Disable.....	38
6.4.2	Enable STD or RTR.....	38
6.4.3	Factory Setting.....	38
6.4.4	Audible & Visible Alarm Enable/Disable	38
7	Sensor And Battery Replacement	39
7.1	External Battery Usage	40
7.2	Replacing The Internal Battery	42
7.3	Sensor Filter Replacement	43
7.4	Sensor Replacement.....	44
8	Appendix A: Warnings	45
9	Appendix B: Controlled Part Of MeshGuard LEL IR (FTD 3000) Manual.....	46
10	External Battery Replacement	59
10.1	External battery replacement	60
10.2	Sensor And Internal Battery Replacement (ATEX/IECEX Only)	61
10.3	Battery Replacement.....	62
10.4	Sensor Replacement.....	63
11	Troubleshooting	64
12	Alarm Signal Summary.....	66
13	Technical Support	67

WARNINGS

Read Before Operating

This manual must be carefully read by all individuals who have or will have the responsibility of using, maintaining, or servicing this product. The product will perform as designed only if it is used, maintained, and serviced in accordance with the manufacturer's instructions.

Warning:

Use only the Lithium battery or external rechargeable battery provided by RAE Systems. This instrument has not been tested in an explosive gas/air atmosphere having an oxygen concentration greater than 21%. Substitution of components may impair suitability for intrinsic safety. Replace batteries only in non-hazardous locations.

STATIC HAZARD: Clean only with a damp cloth.

For safety reasons this equipment must be operated and serviced by qualified personnel only. Read and understand instruction manual completely before operating or servicing. Any rapid up-scale reading followed by a declining or erratic reading may indicate a gas concentration beyond upper scale limit, which may be hazardous.

Warning:

Do not allow condensation to take place within the sensor. Although the infrared sensor used in the product has a humidity range of 0% to 95% non-condensing, care must be used in transporting and using this sensor in higher humidity to prevent condensation from taking place inside the sensor during temperature changes. In some cases of extreme temperature change, the sensor may require a temperature conditioning period before the monitor is turned on.

MeshGuard LEL IR & MeshGuard CO₂ IR User's Guide

Intrinsically safe marking:

FTD-3000 LEL Certification

INMETRO: BR Ex ia IIC T4

CEPEL 10.1925X

IECEX TSA 09.0001X Ex ia I/IIC T4

CE 0575  IM1/II 1G Ex ia I/II C T4

DNV 09 ATEX 55990 X

cCSAus Class I, Division 1, Groups A,B,C, D T4

$-40^{\circ}\text{C} \leq T_{\text{amb}} \leq 50^{\circ}\text{C}$

Entity Parameters: $U_i = 3.6\text{V}$, $C_i = 86\mu\text{F}$, $L_i/R_i = 3.5\mu\text{H}/\text{ohm}$

Warning:

For LEL, cCSAus certification only applies for fixed installations.

FTD-3000 CO₂ certification

INMETRO: BR Ex ia IIC T4

CEPEL 10.1925X

cCSAus: Class I, Division 1, Groups A,B,C,D T4

$-20^{\circ}\text{C} \leq T_{\text{amb}} \leq 50^{\circ}\text{C}$

Entity Parameters: $U_i = 3.6\text{V}$, $C_i = 86\mu\text{F}$, $L_i/R_i = 3.5\mu\text{H}/\text{ohm}$

1 Proper Product Disposal At End Of Life



The Waste Electrical and Electronic Equipment (WEEE) directive (2002/96/EC) is intended to promote recycling of electrical and electronic equipment and their components at end of life. This symbol (crossed-out wheeled bin) indicates separate collection of waste electrical and electronic equipment in the EU countries.

MeshGuard LEL IR & MeshGuard CO₂ IR User's Guide

2 Standard Kit

- Monitor with antenna
- User's Guide
- CD with resources
- Maintenance tool
- Calibration certificate
- Calibration adapter

3 General Information

MeshGuard LEL IR single combustible-gas LEL (Lower Explosive Limit) monitor and the MeshGuard CO₂ IR (CO₂) monitor are integrated with a wireless mesh network-enabled transmission radio module. Each has the option of relaying the wireless signal to other MeshGuard LEL IRs or MeshGuard CO₂ IRs as needed, to bypass obstacles. The built-in radio board operates on a frequency of 2.4GHz and complies with IEEE 802.15.4 standard. Both MeshGuard instruments operate with the FMC-2000 wireless controller on a flexible, robust wireless network to provide reliable, low-cost operation. It also works in a ProRAE Guardian network with a PC, and it supports point-to-point and point-to-multi-point networks.

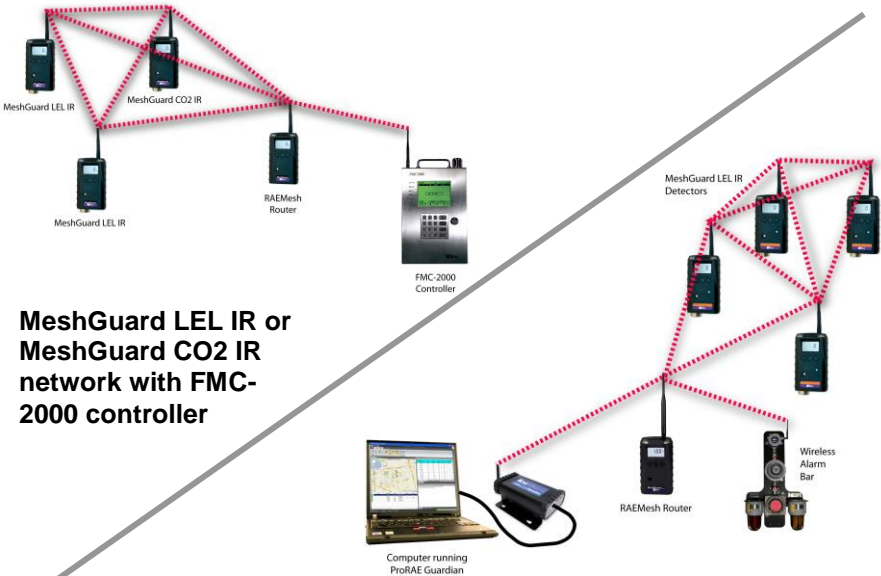

**MeshGuard LEL IR or
MeshGuard CO₂ IR
network with FMC-
2000 controller**

**Network with ProRAEGuardian PC
controller and Wireless Alarm Bar**

Key Features

- LEL: Up to 2 months continuous operation using internal battery and 4 months continuous operation using external BatteryPak.
CO₂: Up to 80 days continuous operation using external BatteryPak.
- IEEE 802.15.4 Mesh network functionality with 64-bit MAC address
- Mesh network with auto network forming and configuration
- Operating distance: up to 300 m, line of sight
- Very low-cost installation – no hardwiring involved
- Large area coverage with multi-hop mesh network
- Field-replaceable battery and sensor
- Loud audio alarm, 90dB @ 30cm (12")
- Large, easy-to-read continuous display of LEL in % or CO₂ in %
- LEL: 0 to 100% LEL.
CO₂: Low-range (0 to 5%) and high-range (0 to 100%) CO₂ sensors available.
- User-adjustable high and low alarms
- Bright red flashing alarm
- Simple calibration
- Highly resistant to RFI interference
- IP-65 rated for outdoor use in harsh environments

4 Physical Description

Note: The physical appearance of the MeshGuard LEL IR and MeshGuard CO₂ IR is virtually identical.



1	LED alarm
2	LCD
3	Buzzer alarm
4	Sensor gas inlet
5	Battery cover (on bottom)
6	Y/+, MODE, and N/- keys
7	Antenna

4.1 LCD Display

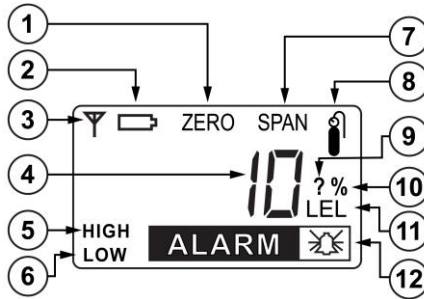

1	Zero Calibration
2	Battery Indicator
3	Wireless Communication (if on continuously, the monitor is in STD; if blinking, the monitor is in RTR)
4	Reading Value
5, 12	High Alarm
6, 12	Low Alarm
7, 8	Span Calibration
9	Save Setting?
10	LEL Unit (%) or CO ₂ Unit (%)
11	LEL or CO ₂ sensor indicator (LEL shown)
12	Alarm Indicator
Remark:	Concentration unit is shown as percentage of LEL or % Vol for CO ₂

MeshGuard LEL IR & MeshGuard CO₂ IR User's Guide

4.2 Specifications

RF Certifications	FCC Part15 CE EN 300328 SRRC(Pending)	
Display	Customized LCD (1 x 1.5") with backlight	
Audible alarm	90dB @ 30cm	
Visual alarm	2 super-bright red LEDs	
Calibration	Two-point field calibration	
RF	IEEE 802.15.4/Zigbee with mesh stack	
Operating Range	Up to 300 meters, line of sight	
Transmission Power	Up to 18dBm (63mw EIRP)	
Receiver Sensitivity	Minimum -95dBm at 2.4GHz	
User Interface	Three keys (Y/+, MODE, N/-)	
Power Supply	Disposable lithium battery, +3.6V (optional re-chargeable external battery for extended run time)	
Max Current Consumption	MeshGuard LEL IR 3.0mA@3.3V (sleep) 0.5mA@3.3V (shut off) <200mA@3.3V during RF transmission	MeshGuard CO₂ IR 18mA@3.3V (sleep) 0.5mA@3.3V (off) <200mA@3.3V during RF transmission
Operation Time	Internal Battery (at normal temperature): STD* Mode: up to 2 months RTR** Mode: up to 10 days External Battery (at normal temperature): STD Mode: up to 4 months RTR Mode: up to 1.5 months	No internal battery usage External Battery (at normal temperature): STD Mode: up to 80 days RTR Mode: up to 40 days
	* STD is standard-function device ** RTR is router-function device	
Operating Temperature	With Internal Battery: LEL: -20° to +50° C (-4° to 122° F) With RAE PowerPak: -40° to +50° C (-40° to 122° F)	With all power sources: -20° to +50° C (-4° to 122° F)
Humidity	10% to 95% relative humidity, non-condensing	

MeshGuard LEL IR & MeshGuard CO₂ IR User's Guide

Specifications, continued

Dimensions	26.5cm x 9.5cm x 5.5cm (10.5" L x 3.7" W x 2.1" H)
Weight	0.6 kg (1.3 lbs)
Package	IP-65
Mounting	Optional stainless-steel bracket mount or magnetic mount; wall mount for external battery

Brazil Radio Specifications

Radio model: RM2400A

Frequency range: 2.400-2.4835GHz

Modulation: 802.15.4 DSSS BPSK

RF power(Tx): 20dBm

Data rate: 250kbps

5 Operating The Instrument

Make sure the battery is installed before operating the MeshGuard LEL IR or MeshGuard CO2 IR. Refer to page 39 for information on battery installation and replacement.

Note: The MeshGuard CO2 IR should be operated with a RAE PowerPak external battery.

5.1 Turning The Instrument On

Hold down the [MODE] key and release it when the instrument beeps. The monitor is now on, as indicated by the display:



The display briefly shows the firmware version (for example, “F1.0” means firmware version 1.0, “F2.0” means firmware version 2.0, etc.):



Then the display shows “SOn” as the sensor comes on.



It begins a sensor warm-up and counts down by seconds from 60 to 1.

MeshGuard LEL IR & MeshGuard CO₂ IR User's Guide

The instrument initiates network communication and shows these displays in alternation:

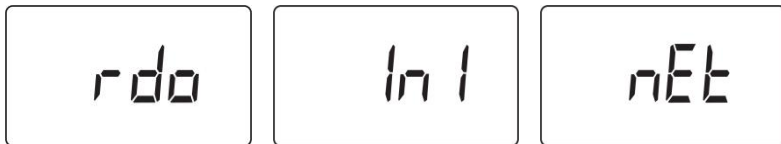

Note: If the instrument is unable to find a radio network to connect with, it searches, and the display alternates between “rdo” and “Srh” (for “radio search”).

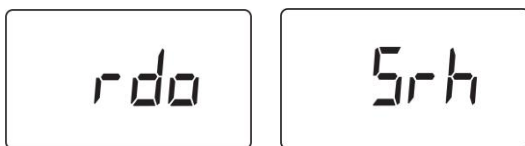

Next, if a network is located, an antenna icon appears (if no network is found, then the icon is not shown; press [Y/+] to search for a network). The current gas concentration reading is also displayed:

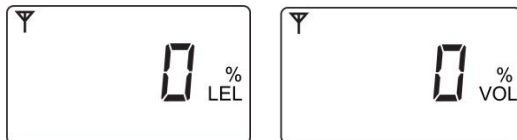

The MeshGuard LEL IR is now operational.

5.2 Turning The Instrument Off

Hold down the [MODE] key through the “5...4...3... 2... 1... oFF” sequence. The monitor is off when the display is blank. Release the [MODE] key.



The instrument is now off.

5.3 Low Battery Indicator & Action

The internal battery is designed for up to 2 months' continuous operation in STD mode (MeshGuard LEL IR only), and the external battery for up to 4 months when powering the MeshGuard LEL IR, up to 80 days when powering the MeshGuard CO₂ IR. When the battery gets low, the instrument's alarm beeps once per minute. It is recommended that the battery be changed immediately, to minimize disruption.

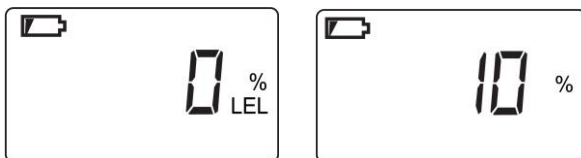

When the battery is completely depleted, the LCD displays “OFF,” and the LED and buzzer alarms activate once per second. The battery icon also blinks on and off. The instrument shuts down after you press any key, or shuts down automatically if you do not press a key for 60 seconds.

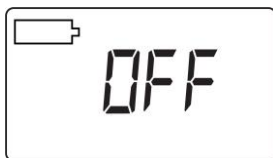

5.4 Over Range Alarm

When a gas concentration exceeds 100% of LEL or 5% of CO₂, the instrument displays “OVR” and its buzzer and LED are activated.

MeshGuard LEL IR & MeshGuard CO₂ IR User's Guide

5.5 Wireless Communication Indicator

When wireless communication is turned on, the LCD displays the wireless link status in the upper left corner:

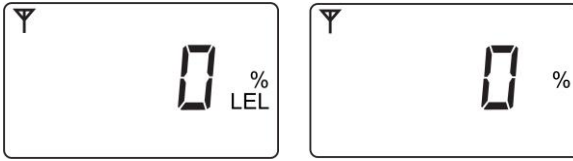

If the instrument finds and joins a wireless network, an antenna icon is shown in the display. If no link or a weak link is established, no antenna icon is shown. Press [Y/+] to manually search for a network.

In RTR mode, the antenna icon flashes on and off, indicating that the modem is always active and transmitting. With an external RAE BatteryPak, the MeshGuard LEL IR can run for up to 45 days, the MeshGuard CO₂ IR up to 40 days.

In STD mode, the antenna icon is shown continuously (solid), indicating that the modem is active whenever alarm data is transmitted. This conserves battery power. With an external RAE BatteryPak, the MeshGuard LEL IR can run for up to 4 months, the MeshGuard CO₂ IR up to 80 days.

5.6 Operation Modes

The instrument can operate in Standard (STD) or Router (RTR) mode. In STD mode, it transmits data to the host at a set interval (the default is 30 seconds) or anytime an alarm occurs. In RTR mode, the MeshGuard LEL IR or MeshGuard CO₂ IR transmits data in real time, and it can also work as a router as needed to relay data from STD devices back to the host.

Note: Operating in RTR mode reduces battery life. The transmission interval can be changed in Programming Mode to extend battery life. See page 21 for details.

In addition, there is a Detection Mode for standard operation, Programming Mode for making changes to values (such as the High Alarm, etc.), Diagnostic Mode (for servicing and checking the sensor, etc.), and Diagnostic Programming Mode, which is for selecting between Standard (STD) & Router (RTR) modes, etc.

The diagram on the next page shows how to enter and step through the menus in each mode.

MeshGuard LEL IR & MeshGuard CO₂ IR User's Guide

Enter Detection Mode by turning the instrument on. Enter Programming Mode from Detection Mode by holding down [MODE] and [N/-] together. To enter Diagnostic Mode, start with the MeshGuard LEL IR turned off and hold both [Y/+] and [MODE] to start it. Once Diagnostic Mode is on, enter Diagnostic Programming Mode by holding [N/-] and [MODE] together.

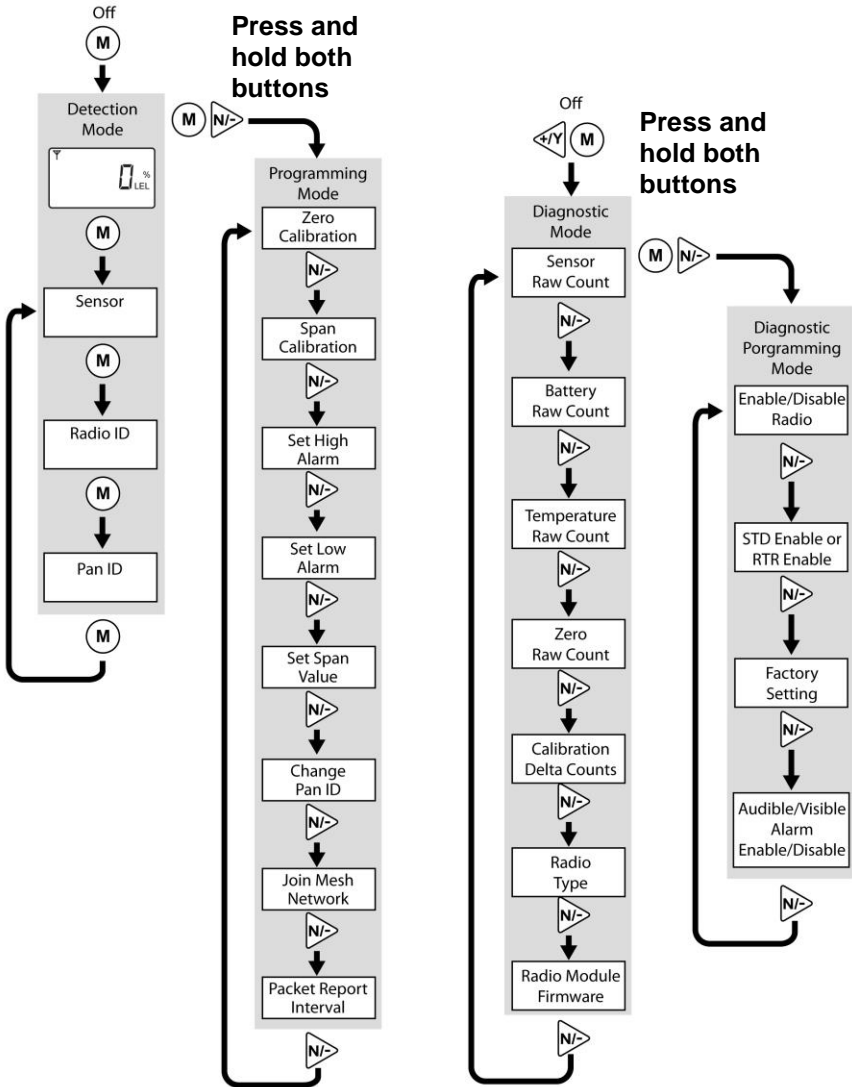

5.7 Detection Mode

Whenever you start MeshGuard LEL IR or MeshGuard CO2 IR by pressing and holding [MODE], it is automatically in Detection Mode.

The instrument displays the current reading:

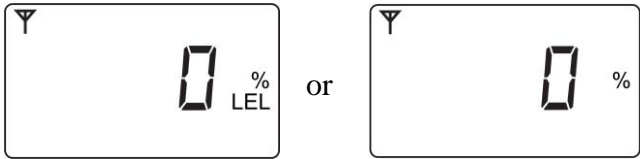

Pressing [MODE] steps through the Detection Mode screens:

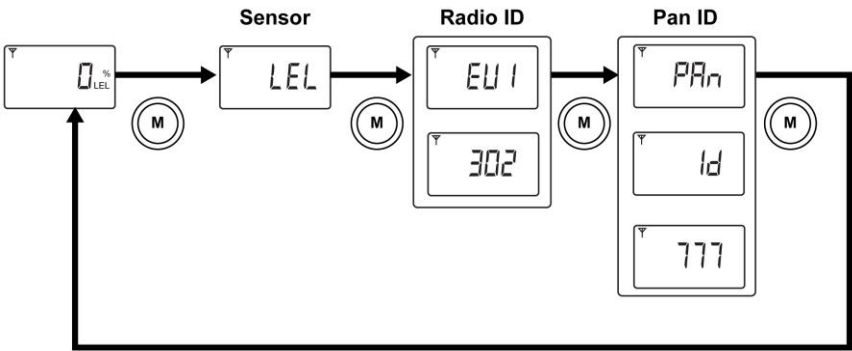

Note: The Sensor shows “CO2” in the MeshGuard CO2 IR instead of “LEL.”

Press [MODE], and it displays the sensor type (LEL shown here):



MeshGuard LEL IR & MeshGuard CO₂ IR User's Guide

Press [MODE], and it alternates between EUI (Extended Unique Identifier) and its value; the EUI is a unique unit ID for each detector in a network:

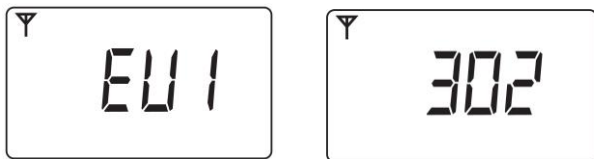

Press [MODE], and it alternates between Pan and ID (Personal Area Network Identifier) and its value (all units in a network must have the same Pan ID):



Press [MODE] to return to the detector reading:

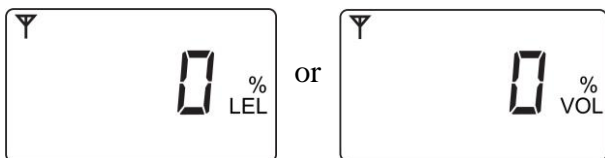

Note: If you do not press a button for 60 seconds, or if an alarm condition occurs, the instrument automatically returns to the main reading screen.

5.8 Manually Sending Data

While the instrument typically sends reading data to the network on a fixed interval, you can send the data anytime.

Press the [Y/+] key. The screen alternates between “Ini” and “nEt” one time, sends the current sensor data, and returns to the detector reading.

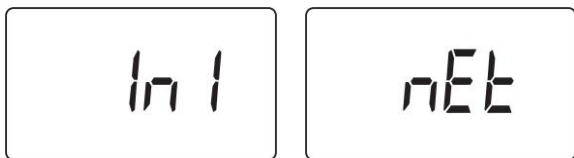

5.9 Programming Mode

Programming Mode allows you to perform any of the following actions (listed in order of appearance):

- Zero Calibration
- Span Calibration
- High Alarm
- Low Alarm
- Change Span Value
- Change Pan ID
- Join Mesh Network
- Communication interval

MeshGuard LEL IR & MeshGuard CO₂ IR User's Guide

5.9.1 Entering Programming Mode

To enter the Programming Mode, press [MODE] and [N/-] for 3 seconds while the instrument is on. "Pro" appears in the display:



Pressing [N/-] steps you through all the screens and then returns to the first programming display:

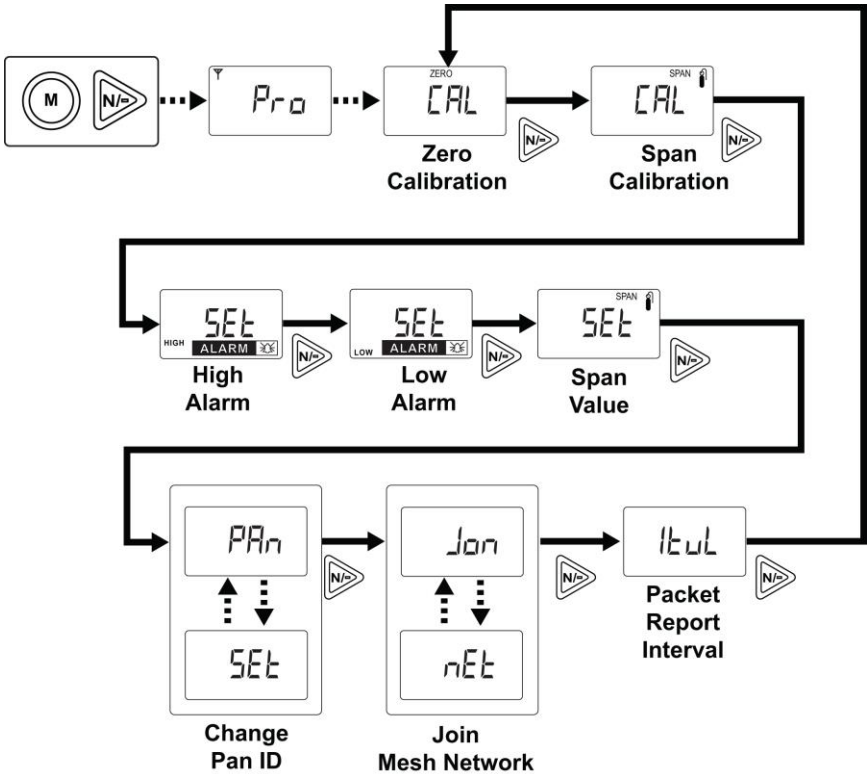

Each display alternates between its name and a status message or value.

Note: You can exit Programming Mode at any time by pressing [MODE]. Also, if you do not make a change within one minute, the instrument exits Programming Mode and returns to Detection Mode.

MeshGuard LEL IR & MeshGuard CO₂ IR User's Guide

Settings can be changed as follows:

1. When a menu is selected, it flashes between two screens. For example:

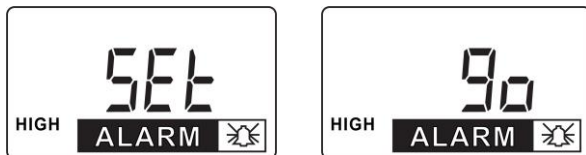

2. Press [MODE] to exit Program Mode and return to Detection Mode, or press [N/-] to advance to the next menu.
3. Press [Y/+] to enter. The LCD displays “go.”

5.9.2 Exiting Programming Mode

You may exit Programming Mode anytime and return to Detection Mode in either of these two ways:

1. Press [MODE]. The instrument exits Program Mode and shows the current reading in Detection Mode.
2. Do not press any buttons for 1 minute. The instrument automatically exits Programming Mode and returns to Detection Mode, showing the current reading.

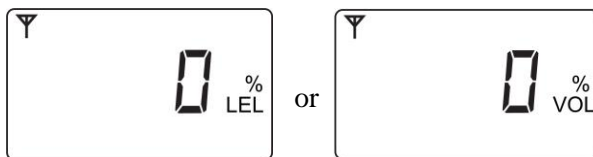

MeshGuard LEL IR & MeshGuard CO₂ IR User's Guide

5.9.3 Zero Calibration

This operation sets the zero point of the sensor calibration curve for clean air. It should be performed before other calibrations.

IMPORTANT!

Even though most toxic gas sensors can be zeroed in fresh air, the CO₂ sensor should *not* be zeroed in fresh air. CO₂ gas is normally present in ambient air, so zeroing the CO₂ sensor in ambient air will not allow for a true zero to be set. The CO₂ sensor should be zeroed in 99.9% pure zero air.

Note: If you use a zero air or other gas cylinder, you must use the MeshGuard Calibration Adapter. A calibration adapter is not necessary for calibrating the MeshGuard LEL IR in clean fresh air.



**Calibration adapter
connected to calibration
gas cylinder**

When “CAL” and “go” are displayed in alternation, and “ZERO” is shown, the instrument is ready to perform a zero calibration.

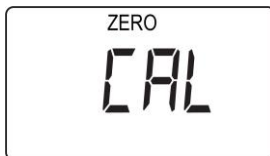

MeshGuard LEL IR & MeshGuard CO₂ IR User's Guide

Press [Y/+]. The LCD displays “go.”

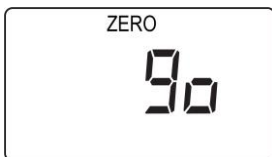

The display counts down from 60 to 0.



After the countdown reaches 0, the LCD displays “dn,” for “done.” The reading should show 0 (zero). Otherwise, repeat the zero calibration. (LEL reading is shown here.)

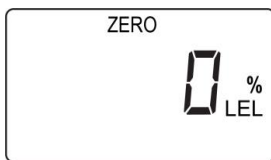
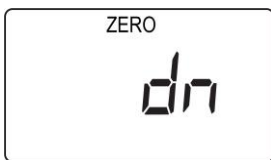

Note: To stop zero calibration before the countdown reaches 0, press any key. The LCD displays “no” and advances to the next programming menu, Span calibration.

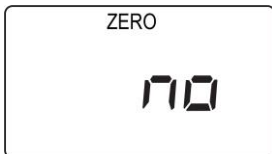

MeshGuard LEL IR & MeshGuard CO₂ IR User's Guide

5.9.4 Span Calibration

“CAL” and “go” flash in alternation, and “SPAN” is shown. The instrument is now ready to perform a span calibration.

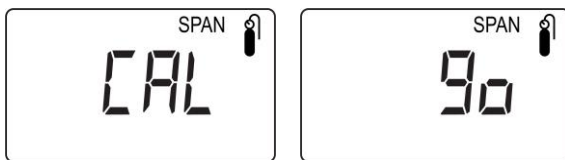

To start calibration, press [Y/+]. The LCD displays “go.”

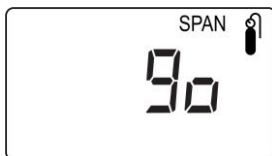

The instrument waits for 10 seconds so that you have time to connect the span gas. Connect the calibration gas adapter to the MeshGuard LEL IR or MeshGuard CO₂ IR, and connect the gas cylinder to the calibration adapter. Start the flow of gas.

When the gas flow starts, the LCD displays “gAS” and the span concentration value. (LEL value is shown here.)

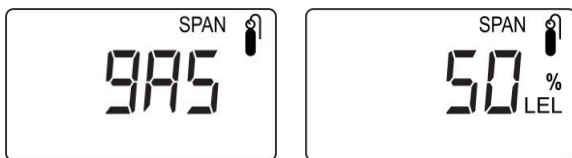

The display now counts down to 0.

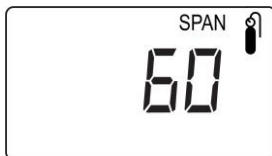

MeshGuard LEL IR & MeshGuard CO2 IR User's Guide

After counting down and reaching 0, the LCD displays “dn.” The reading should be the span concentration value. Otherwise, the span calibration should be repeated. (LEL value is shown here.)

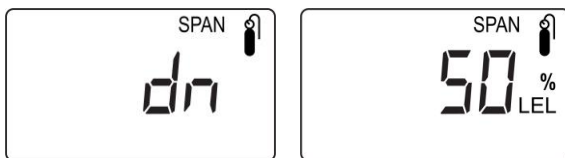

If the MeshGuard LEL IR or MeshGuard CO2 IR does not detect gas after counting down to 0, the LCD displays “Err” (for “error”). The LED glows red and the buzzer sounds to provide extra warning. The MeshGuard LEL IR automatically returns to the span calibration display.

Note: This could mean the sensor is contaminated or expired.

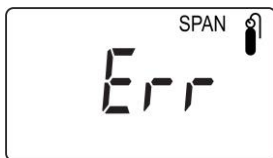

Note: To stop span calibration before the countdown reaches 0, press any key. The LCD displays “no” and advances to the next programming menu, Change High Alarm.

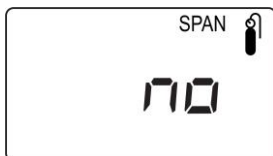

If the sensor fails, try to recalibrate it again. If calibration fails again, replace the sensor.

IMPORTANT!

Due to certification requirements, the MeshGuard LEL IR's High Alarm and Low Alarm values cannot be set above 60% LEL.

MeshGuard LEL IR & MeshGuard CO₂ IR User's Guide

5.9.5 Change High Alarm

At the menu for changing the High Alarm setting, “Set” and “go” flash in alternation, and both “HIGH” and “ALARM” are shown.

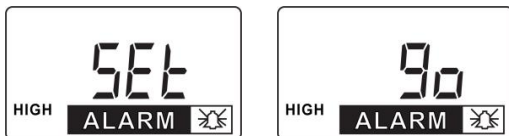

Press [Y/+] to enter and change the setting. Press [MODE] to go back to Detection Mode or [N] to advance to the next menu.

The LCD displays the current value. Change the value if necessary. (LEL value is shown here.)



To change the value:

1. Press [Y/+] to increase the number and [N/-] to decrease it.
2. Press [MODE] to advance to the next digit.
3. After moving to the last digit and making changes, press [MODE]. A question mark (?) is shown in the display, asking if you want to save the change.
 - Press [Y/+] for yes. The message “dn” means the change is done.
 - Press [N/-] for no. A “no” message means that the change was abandoned.
 - Press [MODE] to return to the first digit.

Note: Due to certification requirements for the MeshGuard LEL IR, the maximum value you can set for High Alarm is 60. If you set a value above 60 and try to save it, the display shows “no” and it does not accept your change, plus it retains the current stored value.

MeshGuard LEL IR & MeshGuard CO₂ IR User's Guide

5.9.6 Change Low Alarm

At the Change Low Alarm menu, “Set” and “go” flash in alternation, and “LOW” and “ALARM” are visible in the display.



Press [Y/+] to enter and change the setting. Press [MODE] to exit and return to Detection Mode or [N] to advance to the next menu.

The LCD displays current value. Change the value if necessary. (LEL value is shown here.)



To change the value:

1. Press [Y/+] to increase the number and [N/-] to decrease it.
2. Press [MODE] to advance to the next digit.
3. After moving to the last digit and making changes, press [MODE]. A question mark (?) is shown in the display, asking if you want to save the change.
 - Press [Y/+] for yes. The message “dn” means the change is done.
 - Press [N/-] for no. A “no” message means that the change was abandoned.
 - Press [MODE] to return to the first digit.

Note: Due to certification requirements for the MeshGuard LEL IR, the maximum value you can set for Low Alarm is 60. If you set a value above 60 and try to save it, the MeshGuard LEL IR's display shows “no” and it does not accept your change, plus it retains the current stored value.

MeshGuard LEL IR & MeshGuard CO₂ IR User's Guide

5.9.7 Change SPAN value

“Set” and “go” flash in alternation, and “SPAN” and a gas cylinder icon are shown.

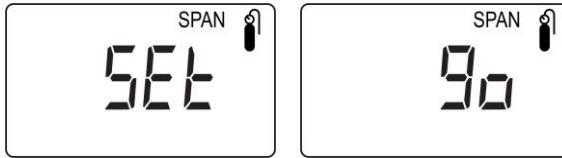

Press [Y/+] to enter and change the setting, [MODE] to exit and return to Detection Mode, or [N/-] to advance to the next menu.

The LCD displays the current value. Change the value if necessary. (LEL value is shown here.)



To change the value:

1. Press [Y/+] to increase the number and [N/-] to decrease it.
2. Press [MODE] to advance to the next digit.
3. After moving to the last digit and making changes, press [MODE]. A question mark (?) is shown in the display, asking if you want to save the change.
 - Press [Y/+] for yes. The message “dn” means the change is done.
 - Press [N/-] for no. A “no” message means that the change was abandoned.
 - Press [MODE] to return to the first digit.

MeshGuard LEL IR & MeshGuard CO₂ IR User's Guide

5.9.8 Change Pan ID

Note: All MeshGuards (including MeshGuard Routers) in a network must have the same Pan ID.

Press Y/+ to enter the menu to make changes to the value.

1. Press [Y/+] to increase the number and [N/-] to decrease it.
2. Press [MODE] to advance to the next digit.
3. After moving to the last digit and making changes, press [MODE]. A question mark (?) is shown in the display, asking if you want to save the change.
 - Press [Y/+] for yes. The message “dn” means the change is done.
 - Press [N/-] for no. A “no” message means that the change was abandoned.
 - Press [MODE] to return to the first digit.

5.9.9 Join Mesh Network

Press [Y/-] to initiate joining a network. Three bars flash in sequence while it searches. When it is done, it alarms once and displays “dn” for “done.”

5.9.10 Change Communication Interval

This menu allows you to change the interval between wireless transmissions. “SET” and “ItUL” flash, to indicate that you can change the interval. The interval can be set to 10, 30, 60, 300, or 600 seconds.

Note: The default interval is 30 seconds.

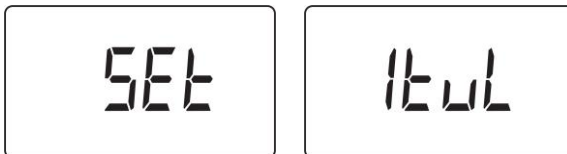

MeshGuard LEL IR & MeshGuard CO₂ IR User's Guide

Press [Y/+] to enter and change the setting, [MODE] to exit and return to Detection Mode, or [N/-] to advance to the next MENU.



6 Diagnostic Mode

Diagnostic Mode provides raw data from sensors and about settings.

6.1 Entering Diagnostic Mode

Note: To enter Diagnostic Mode, you must begin with the MeshGuard LEL IR or MeshGuard CO2 IR turned off.

Press and hold [Y/+] and [MODE] until the MeshGuard LEL IR starts.

The instrument goes through a brief startup, and then displays “dIA” to indicate it is in Diagnostic Mode. It then switches to showing raw data for the sensor (the display shows “rAU” followed by a number, or “- - -” if there is no diagnostic information).

The following chart shows how to navigate Diagnostic Mode (pressing [N/-] repeatedly steps through the screens):

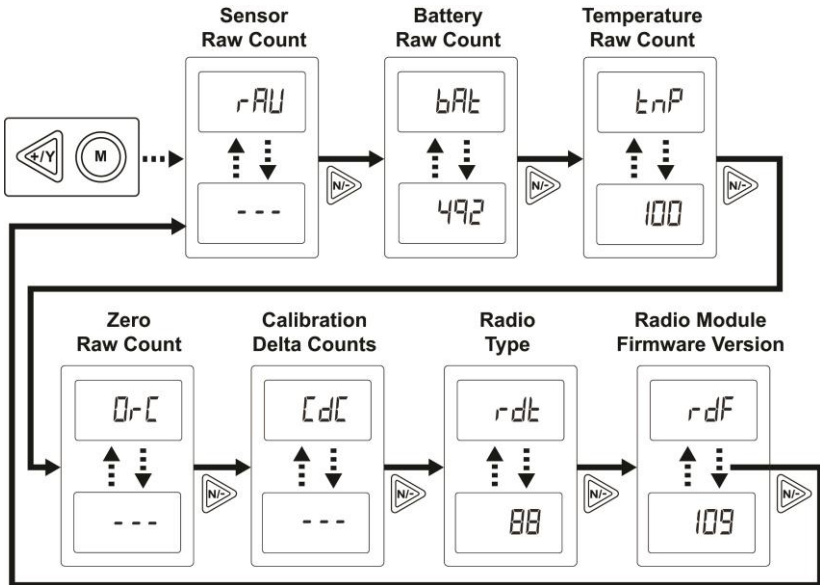

6.2 Exiting Diagnostic Mode

Note: You can exit Diagnostic Mode and enter Programming Mode and calibrate the MeshGuard LEL IR as usual by pressing both [MODE] and [N/-] for three seconds. When entering Programming Mode from Diagnostic Mode, additional menu options are available. Refer to the diagram on page 36 for more details.

Note: You can exit Diagnostic Mode and enter Detection Mode by pressing [MODE] and [Y/+] together for three seconds, or by turning it off and on again.

6.3 Diagnostic Mode Readings

In Diagnostic mode, you can step through readings by pressing [N/-].

6.3.1 Sensor Raw Count

Sensor Raw Count is indicated by “rAU” followed by three dashes (- - -). This indicates that the sensor has digital output that does not produce a raw count.

- Press [N/-] to advance to the next reading.
- Press [MODE] and [Y/+] together for three seconds to exit Diagnostic Mode and enter Detection Mode.

6.3.2 Battery Raw Count

Battery Raw Count is indicated by “bAt” followed by a number.

- Press [N/-] to advance to the next reading.
- Press [MODE] and [Y/+] together for three seconds to exit Diagnostic Mode and enter Detection Mode.

6.3.3 Temperature Raw Count

Temperature Raw Count is indicated by “tNp” followed by a number.

- Press [N/-] to advance to the next reading.
- Press [MODE] and [Y/+] together for three seconds to exit Diagnostic Mode and enter Detection Mode.

MeshGuard LEL IR & MeshGuard CO₂ IR User's Guide

6.3.4 Zero Raw Count

Zero Raw Count is indicated by “0rC” followed by three dashes (- - -). This indicates that the sensor has digital output that does not produce a raw count.

- Press [N/-] to advance to the next reading.
- Press [MODE] and [Y/+] together for three seconds to exit Diagnostic Mode and enter Detection Mode.

6.3.5 Calibration Delta Counts

Calibration Delta CTS is indicated by “CdC” by three dashes (- - -). This indicates that the sensor has digital output that does not produce a raw count.

- Press [N/-] to return to the first raw count.
- Press [MODE] and [Y/+] together for three seconds to exit Diagnostic Mode and enter Detection Mode.

6.3.6 Radio Type

The radio module type is indicated by “rdt” followed by a number.

- Press [N/-] to advance to the next reading.
- Press [MODE] and [Y/+] together for three seconds to exit Diagnostic Mode and enter Detection Mode.

6.3.7 Radio Module Firmware Version

Radio Module Firmware Version is indicated by “rdF” followed by a number (for example, “109” stands for version 1.09).

- Press [N/-] to return to the first raw count.
- Press [MODE] and [Y/+] together for three seconds to exit Diagnostic Mode and enter Detection Mode.

6.4 Diagnostic Mode Programming

You can enter a special programming mode from Diagnostic Mode in order to perform advanced programming functions. These include:

- Enable/disable radio
- Enable STD or RTR
- Return the instrument to original factory settings
- Enable/disable audible and visible alarms

Note: When the MeshGuard LEL IR or MeshGuard CO₂ IR is in this programming mode, if you do not make a change or press a key for 60 seconds, it reverts to the standard Diagnostic Mode.

Important! After you make changes in Diagnostic Mode, it is recommended that you turn off the instrument and turn it on again before using it. Enter this programming mode by first entering Diagnostic Mode. This requires starting the instrument while holding [Y/+] and [MODE]. When you see the Sensor Raw Count screen, hold [MODE] and N/- until you see “Pro” in the display, indicating that you are in Programming Mode.

MeshGuard LEL IR & MeshGuard CO₂ IR User's Guide

Step through the menus by pressing [N/-]. Exit by pressing [MODE], and then shutting off the instrument and restarting it.

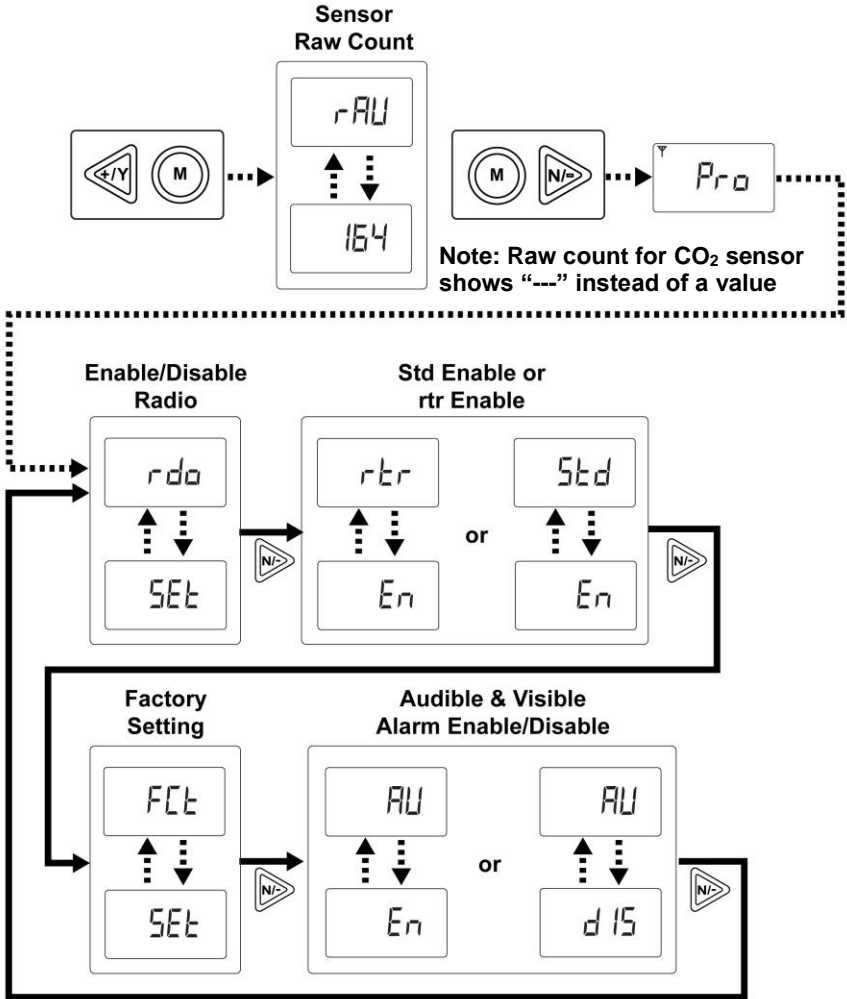

MeshGuard LEL IR & MeshGuard CO₂ IR User's Guide

6.4.1 Radio Enable/Disable

The next menu is for turning the radio on or off.

“SEt” and “rdo” flash in alternation, to indicate that the radio can be turned on (enabled) or off (disabled). The default value is “on.”



Press [Y/+] to enter and change the setting, [MODE] to exit and return to Detection Mode, or [N/-] to go to the next menu.

The LCD displays the current value (enabled or disabled). Change the value if necessary.

Note: “dIS” means disabled (radio off) and “En” means on (radio on).



6.4.2 Enable STD or RTR

Press [Y/+] to toggle the setting from STD to RTR, and vice versa. For details on STD and RTR modes, see page 17.

6.4.3 Factory Setting

Press [Y/+] to return the MeshGuard LEL IR to its original factory settings.

6.4.4 Audible & Visible Alarm Enable/Disable

Press [Y/+] to toggle between the MeshGuard LEL IR's audible and visible alarms turned on and off.

7 Sensor And Battery Replacement



MeshGuard LEL IR & MeshGuard CO₂ IR User's Guide

7.1 External Battery Usage

An external battery unit, the RAE Systems RAE PowerPak, should be used with the MeshGuard CO₂ IR instead of a smaller battery. A RAE PowerPak is used to power the MeshGuard LEL IR in situations where extended battery life is necessary. The connector from the external battery screws into the instrument's battery compartment. Bottom views of the instrument in its steel enclosure are shown in the procedure below.

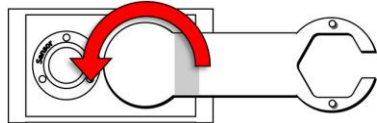
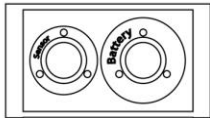

1. Remove battery cover with the 3-pin end of the sensor and battery removal tool by turning counterclockwise.

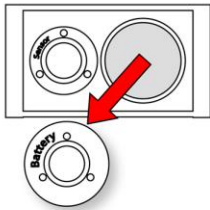

2. Lift off the cover.

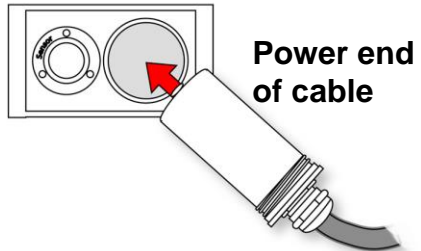

3. Insert the power end of the cable connected to the PowerPak.

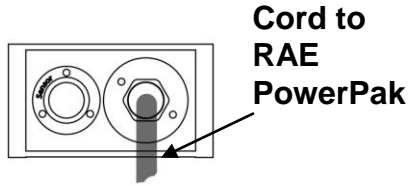
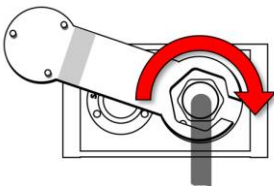

4. Use the open hex end of the wrench, and with both pins mated with the two holes on the power end, tighten by turning clockwise until it is snug. Do not overtighten.

MeshGuard LEL IR & MeshGuard CO2 IR User's Guide

Consult the RAE PowerPak User's Guide for further connection and charging information.

The MeshGuard LEL IR or MeshGuard CO2 IR is permanently mounted to a solid surface by first securing it in its steel enclosure (a screw through the back mates with the instrument) and then securing the enclosure to a solid surface such as a wall or the metal mounting plate.

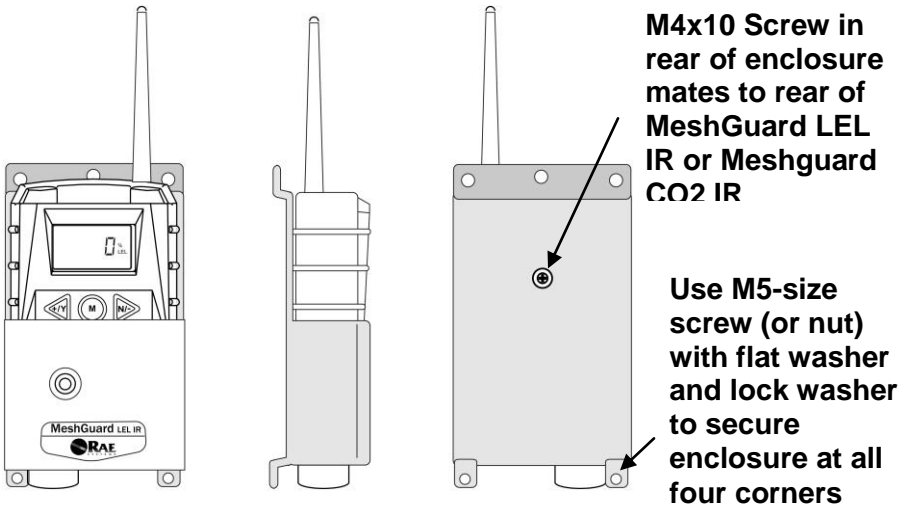

Front, side, and rear views of the steel enclosure show how the instrument is secured for mounting.

MeshGuard LEL IR & MeshGuard CO₂ IR User's Guide

7.2 Replacing The Internal Battery

With the MeshGuard LEL IR or MeshGuard CO₂ IR securely in its housing, you can remove the cover over the battery compartment so that you can replace the internal battery in the instrument. Use the sensor and battery removal tool as shown.

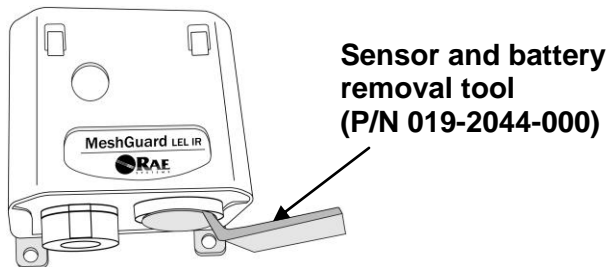

WARNING: Use only RAE Systems battery P/N 500-0111-000 (EVE ER34615 or XENO XL-205F) for the internal battery. The internal battery must be replaced under a Hot Work Permit, where the atmosphere is determined to be non-hazardous while the battery is being replaced.

7.3 Sensor Filter Replacement

The filter should be replaced when it is visibly dirty. If readings fluctuate up even after a zero calibration, this may indicate a dirty filter.

1. Use the 3-pin end of the tool to unscrew and open the filter holder by turning it counterclockwise.

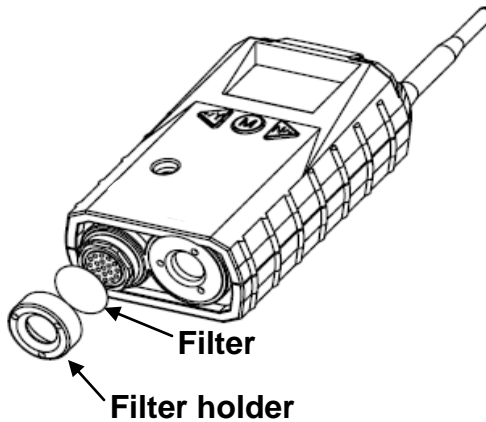

2. Remove and discard the filter.
3. Place a new filter inside the monitor.
4. Replace the filter holder by turning it clockwise with the 3-pin end of the tool.

7.4 Sensor Replacement

1. Use the 3-pin end of the sensor and battery tool to unscrew and open the filter holder at the bottom of the monitor.

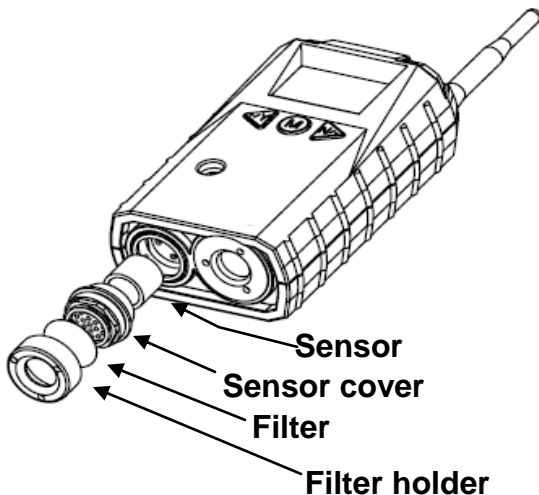

2. Use the hexagonal end of the tool to open the remove the sensor cover, turning counterclockwise.
3. Pull the old sensor out.
4. Gently push a new sensor into the compartment.

Important! Ensure that the RAE Systems part number matches the sensor that was removed.

WARNING! Use only the same sensor model as the one installed when the monitor was purchased.

5. Replace the sensor compartment cover using by turning it clockwise, using the hexagonal end of the tool.
6. Replace the filter holder by turning it clockwise, using the 3-pin end of the tool.

Note: Always recalibrate the instrument after service to ensure functionality.

8 Appendix A: Warnings

Read Before Operating

This manual must be carefully read by all individuals who have or will have the responsibility of using, maintaining, or servicing this product. The product will perform as designed only if it is used, maintained, and serviced in accordance with the manufacturer's instructions.

Warning:

Use only the Lithium battery provided by RAE Systems. This instrument has not been tested in an explosive gas/air atmosphere having an oxygen concentration greater than 21%. Substitution of components may impair suitability for intrinsic safety. Replacement of batteries only in non-hazardous locations.

STATIC HAZARD: Clean only with a damp cloth.

For safety reasons this equipment must be operated and serviced by qualified personnel only. Read and understand instruction manual completely before operating or servicing. Any rapid up-scale reading followed by a declining or erratic reading may indicate a gas concentration beyond upper scale limit, which may be hazardous.

FCC Part 15 statement and CE

This device complies with Part 15 of the FCC rules. Operation is subject to the following two conditions: (1) This device may not cause harmful interference, and (2) this device must accept any interference received, including interference that may cause undesired operation.

9 Appendix B: Controlled Part Of MeshGuard LEL IR (FTD 3000) Manual

Intrinsic Safety: IECEx TSA 09.0001X Ex ia I/IIC T4

CE 0575  IM1/II 1G Ex ia I/II C T4

DNV 09 ATEX 55990 X

cCSAus Class I, Division 1, Groups A,B,C, D T4

$-40^{\circ}\text{C} \leq T_{\text{amb}} \leq 50^{\circ}\text{C}$

Entity Parameters: $U_i = 3.6\text{V}$, $C_i = 86\mu\text{F}$, $L_i/R_i = 3.5\mu\text{H}/\text{ohm}$

EM Immunity: No effect when exposed to $0.43\text{mW}/\text{cm}^2$ RF interference (5-watt transmitter at 12").

Temperature: -40°C to 50°C (-40°F to 122°F)

Humidity: 0% to 95% relative humidity (non-condensing)

WARNING! (cCSAus only)

CERTIFICATION ONLY APPLIES FOR FIXED INSTALLATIONS.

WARNING!

ONLY THE COMBUSTIBLE GAS DETECTION PORTION OF THIS INSTRUMENT HAS BEEN ASSESSED FOR PERFORMANCE.

UNIQUIMENT, LA PORTION POUR DETECTOR LES GAZ COMBUSTIBLES DE CET INSTRUMENT A ÉTÉ ÉVALUÉE.

CAUTION!

HIGH OFF-SCALE READINGS MAY INDICATE AN EXPLOSIVE CONCENTRATION OF GAS.

MeshGuard LEL IR & MeshGuard CO₂ IR User's Guide

Note: Users are recommended to refer to ISA -RP12.13, Part II-1987 for general information on installation, operation, and maintenance of combustible gas detection instruments.

- Only the combustible gas detection portion of this instrument has been assessed for performance.
- Any rapid up-scale reading followed by a declining or erratic reading may indicate a gas concentration beyond upper scale limit which may be hazardous.

WARNING (cCSAus only): WIRELESS COMMUNICATION IS INTENDED FOR USE AS A SECONDARY REMOTE ALARM STATUS NOTIFICATION ONLY. PRIMARY ALARMING OF COMBUSTIBLE GAS HAZARDS IS PROVIDED LOCALLY BY THE DETECTOR.

WARNING: SUBSTITUTION OF COMPONENTS MAY IMPAIR INTRINSIC SAFETY.

MeshGuard LEL IR Range, Resolution & Response Time:

Range: 0 to 100% LEL

Resolution: 1% LEL

Response Time (T₉₀): <30 seconds

MeshGuard LEL IR & MeshGuard CO₂ IR User's Guide

Sensor And Internal Battery Replacement

The MeshGuard LEL IR is permanently mounted to a solid surface by first securing it in its steel enclosure (a screw through the back mates with the instrument) and then securing the enclosure to a solid surface such as a wall or the metal mounting plate.

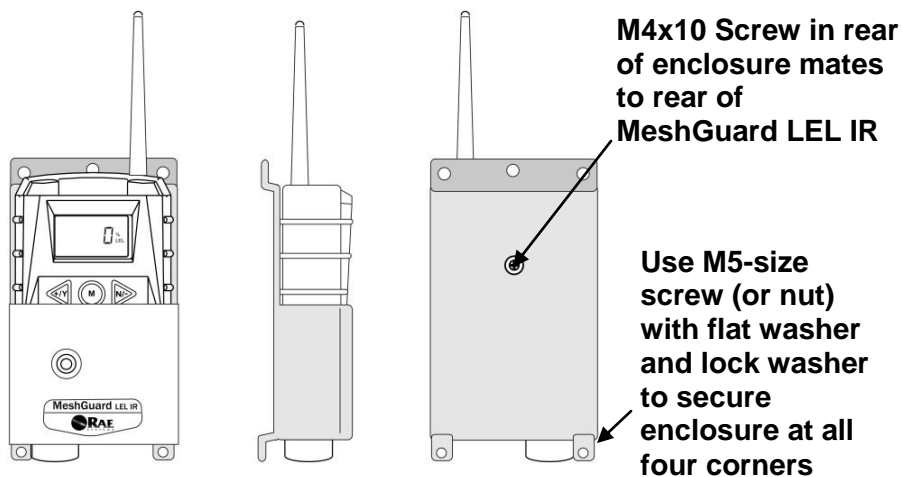

Front, side, and rear views of the steel enclosure show how the instrument is secured for mounting.

With the instrument securely in its housing, you can remove the cover over the battery compartment so that you can replace the internal battery in the MeshGuard LEL. Use the sensor and battery removal tool as shown.

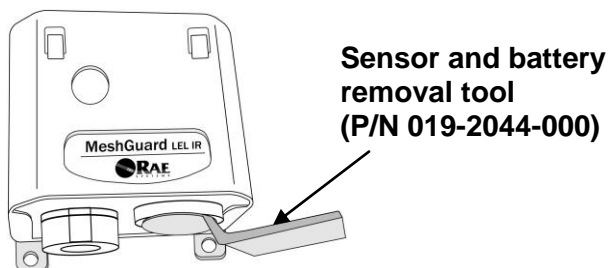

MeshGuard LEL IR & MeshGuard CO₂ IR User's Guide

WARNING: Use only RAE Systems battery P/N 500-0111-000 (EVE ER34615 or XENO XL-205F) for the internal battery. The internal battery must be replaced under a Hot Work Permit, where the atmosphere is determined to be non-hazardous while the battery is being replaced.

MeshGuard LEL IR Installation With External Power Battery Pack (FTB-1000)

Use M8-size screw (or nut), flat washer, and lock washer

Use M8-size screw (or nut), flat washer, and lock washer

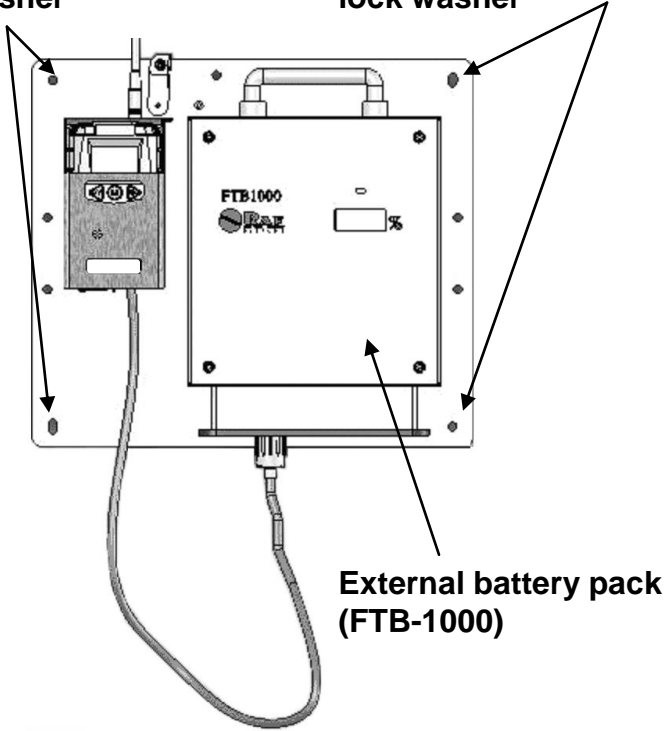

External battery pack (FTB-1000)

Note: The plate holding the battery pack and MeshGuard LEL IR must be mounted on a solid, flat surface.

Turning The Instrument On

To turn the MeshGuard LEL IR on, hold down [MODE] for 2 seconds.

Caution: The alarm is very loud. During startup, you can mute most of the sound by holding a finger over the alarm port.

Note: Do not put tape over the alarm port to permanently mute it.

When starting up, the instrument simultaneously turns the backlight on and off, beeps once and blinks once. The screen shows:

On...
Firmware version
Count down from 60 to 0

The instrument performs a final checkout and the screen shows a countdown to full operational functionality.

Turning The Instrument Off

Press and hold [MODE]. In 2 seconds, a 5-second countdown to shutoff begins. You must hold your finger on the key for the entire shutoff process. If you remove your finger from the key during the countdown, the shutoff operation is canceled and the instrument continues normal operation.

The countdown proceeds as follows, accompanied at each step with an alarm beep and light flash. The display shows the countdown in sequence:

5
4
3
2
1
off

When you see “off,” release your finger from the [MODE] key. The instrument is now off.

Caution: The alarm is very loud. During shutdown, you can mute most of the sound by holding a finger over the alarm port.

Programming Mode

Programming Mode can be entered from Normal Mode or Diagnostic Mode. This mode contains most adjustable settings for the instrument. It is organized into four submenus:

The following diagram shows how to enter Programming Mode from Normal Mode:

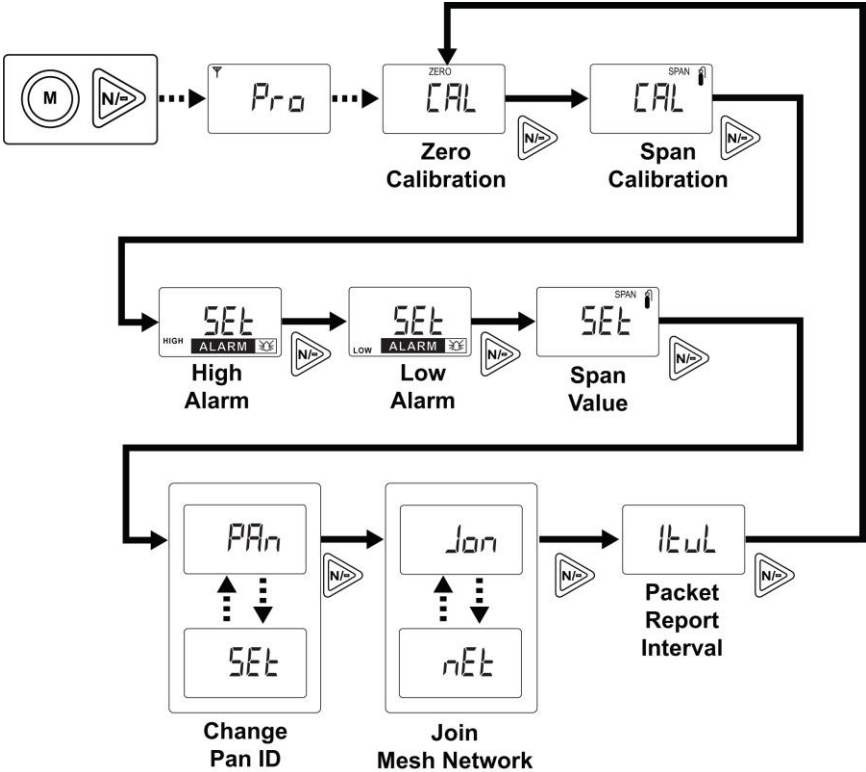

Modify Span Gas Value. This function allows selection of the gas concentration to the settings, press [MODE] to repeat stepping through the choices.

MeshGuard LEL IR & MeshGuard CO₂ IR User's Guide

Back. Press [MODE] to return to the top of the Calibrate Monitor menu, or press [Y/+] to return to the top of the Normal Mode menu.

Change Alarm Limits

The high and low alarm limits, the points at which alarms are triggered, can be modified in this set of menus.

Alarm Signals. During each measurement period, the gas concentration is compared with the programmed alarm limits (gas concentration alarm limit settings: Low and High). If the concentration exceeds any of the preset limits, the loud buzzer, and red flashing LED are activated immediately to warn of the alarm condition. In addition, the instrument alarms if the battery voltage falls below a preset voltage level.

When the low battery alarm occurs, there will be approximately 20 to 30 minutes of operating time remaining. When the battery voltage falls below the low threshold, the instrument turns off automatically.

Over Range Alarm

When a gas concentration exceeds 100% of LEL, the MeshGuard LEL IR displays “OVR” and its buzzer and LED are activated.

Calibrating MeshGuard LEL IR

- Calibration intervals and procedures may vary due to national legislation.
- Calibration gas flow should be verified and be between 400 cc/min and 800 cc/min.

IMPORTANT!

If you use a zero air or other gas cylinder, you must use the MeshGuard Calibration Adapter. A calibration adapter is not necessary for calibrating the MeshGuard LEL IR in clean fresh air.

Connecting Calibration Gas

1. Connect the calibration gas to the MeshGuard LEL IR as shown.

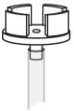

**Calibration adapter
connected to calibration
gas cylinder**

MeshGuard LEL IR & MeshGuard CO₂ IR User's Guide

Zero Calibration

When “CAL” and “go” are displayed in alternation, and “ZERO” is shown, the instrument is ready to perform a zero calibration.

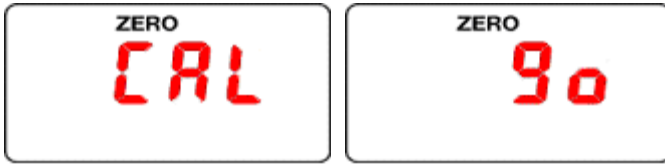

Press [Y/+]. The LCD displays “go.”



The display counts down from 10 to 0.



After the countdown reaches 0, the LCD displays “dn,” for “done.” The reading should show 0 (zero). Otherwise, repeat the zero calibration.

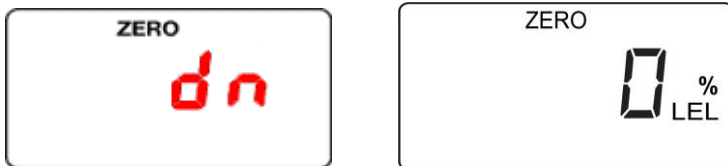

Note: To stop zero calibration before the countdown reaches 0, press any key. The LCD displays “no” and advances to the next programming menu, Span calibration.

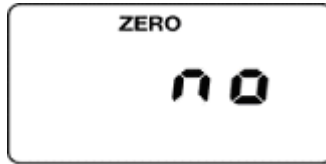

Span Calibration

“CAL” and “go” flash in alternation, and “SPAN” is shown. The instrument is now ready to perform a span calibration.

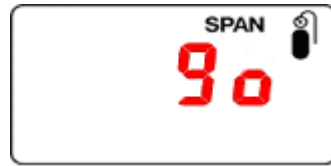

To start calibration, press [Y/+]. The LCD displays “go.”

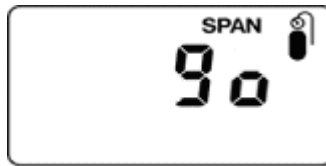

The instrument waits for 10 seconds so that you have time to connect the span gas. Connect the calibration gas adapter to the instrument, and connect the gas cylinder to the adapter. Start the flow of gas.

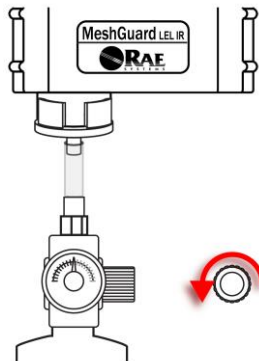

MeshGuard LEL IR & MeshGuard CO₂ IR User's Guide

When the gas flow starts, the LCD displays “gAS” and the span concentration value.

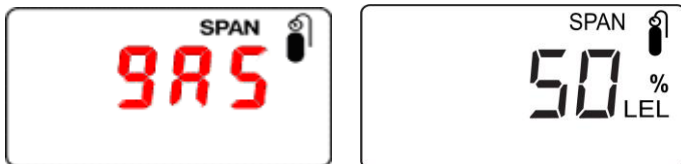

The MeshGuard LEL IR now counts down to 0.

Note: The countdown time varies according to the type of sensor used in the instrument.

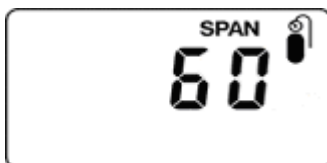

After counting down and reaching 0, the LCD displays “dn.” The reading should be the span concentration value. Otherwise, the span calibration should be repeated.

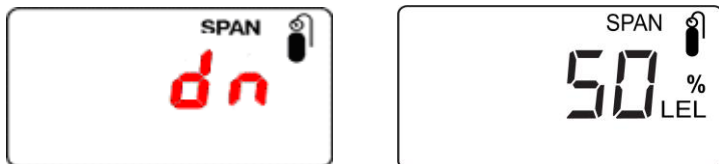

If the instrument does not detect gas after counting down to 0, the LCD displays “Err” (for “error”). The LED glows red and the buzzer sounds to provide extra warning. The instrument automatically returns to the span calibration display.

MeshGuard LEL IR & MeshGuard CO₂ IR User's Guide

Note: This could mean the sensor is contaminated or expired.



Note: To stop span calibration before the countdown reaches 0, press any key. The LCD displays “no” and advances to the next programming menu, Change High Alarm.

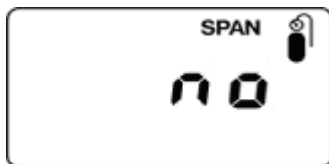

If the sensor fails, try to calibrate it again. If calibration fails again, replace the sensor.

10 External Battery Replacement

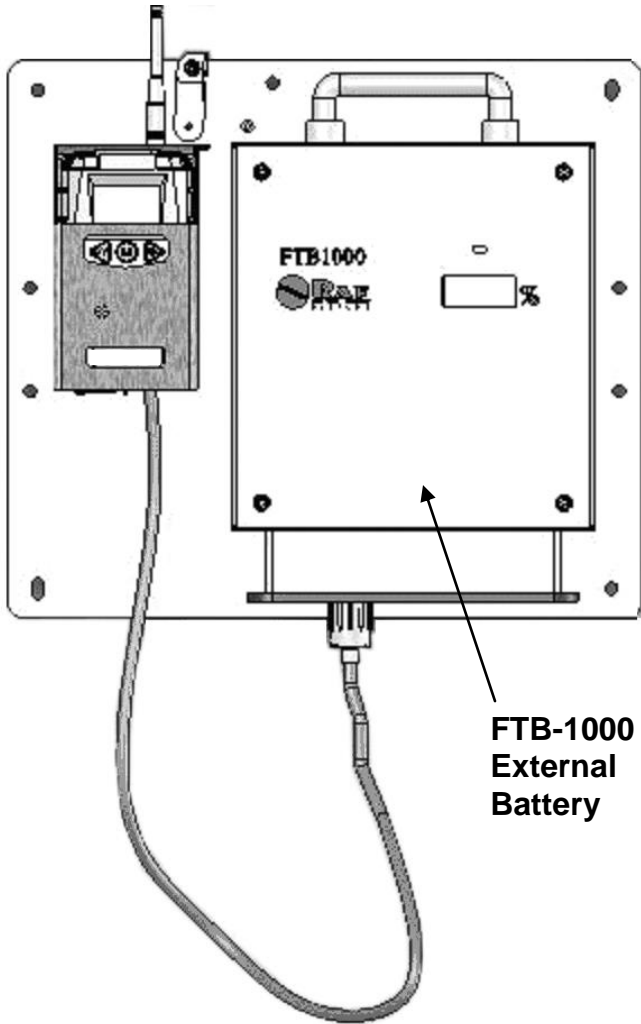

10.1 External battery replacement

1. Unplug the battery connector
2. Loosen the safety screw holding the battery
3. Mount a new battery on the mounting bracket
4. Tighten the safety screw
5. Connect the MeshGuard LEL IR to the battery.
6. Switch on the instrument.

Note: Always recalibrate the instrument after service.

10.2 Sensor And Internal Battery Replacement (ATEX/IECEX Only)



10.3 Battery Replacement

RAE Systems offers two types of batteries: internal battery and external battery pack.

1. Use the 3-pin end of the tool to unscrew and open the battery cover by turning it counterclockwise.
2. Remove the battery.
3. Insert the new battery with its positive (“+”) pole towards inside of the unit.
4. Replace the battery cover by turning it clockwise with the 3-pin end of the tool.

Note: Only change the battery in non-hazardous locations, and use the battery RAE Systems provides, part number 500-0111-000 (EVE model ER34615 or XENO XL-205F). Only remove the external battery adapter in non-hazardous locations.

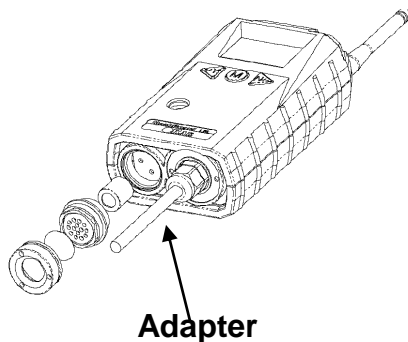
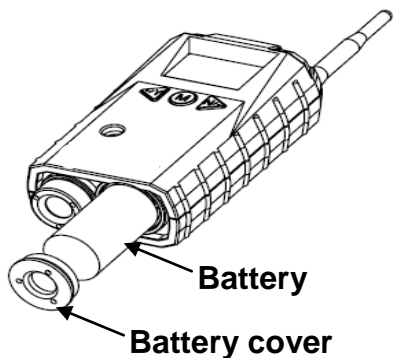

10.4 Sensor Replacement

1. Use the 3-pin end of the tool to unscrew and open the filter holder at the bottom of the monitor.

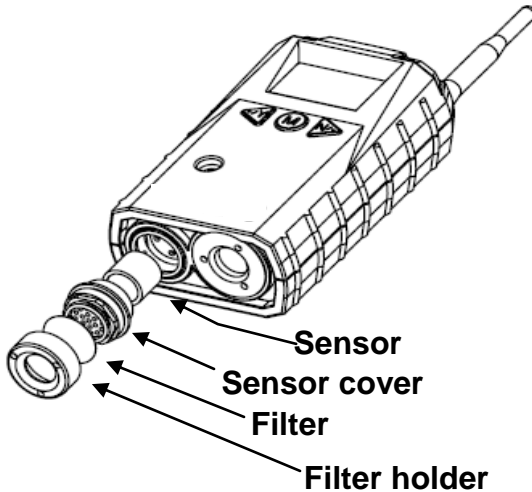

2. Use the hexagonal end of the tool to open the remove the sensor cover, turning counterclockwise.
3. Pull the old sensor out.
4. Gently push a new sensor into the compartment.
5. Replace the sensor compartment cover using by turning it clockwise, using the hexagonal end of the tool.
6. Replace the filter holder by turning it clockwise, using the 3-pin end of the tool.

WARNING: Only replace the sensor in non-hazardous locations.

MeshGuard LEL IR & MeshGuard CO₂ IR User's Guide

11 Troubleshooting

Failure Symptom	Cause	Solution
Cannot turn on	Battery charge too low	Replace battery Check RAE Systems web site for information on batteries
OVR (over range) alarm	Over 100% LEL (LEL sensor only) or over the range of the CO ₂ sensor Condensation inside	Move monitor to a clean environment and allow sensor to clear Move monitor to a dry environment, remove sensor filter, and allow sensor to dry out
“—0” Alarm	Sensor zero drift	Perform zero calibration
Controller cannot receive the MeshGuard LEL IR's or MeshGuard CO ₂ IR's signal	Too much distance between the MeshGuard LEL IR or Meshguard CO ₂ IR and the controller. There is an obstruction between the instrument and the controller. Controller does not receive completed data packet Battery is low MeshGuard LEL/CO ₂ IR and controller have different Pan ID numbers	The distance should be 300 m, line of sight. Deploy a router between the remote monitor and the controller. Relocate the instrument or deploy RTR mode in instrument or MeshGuard Router(s). Press [Y/+] on the detector to force it to send data packets Replace battery Set both units to have the same Pan ID number

MeshGuard LEL IR & MeshGuard CO₂ IR User's Guide

No Antenna Icon	There is no reader or controller nearby. The controller or reader's network has changed. The instrument is out of its RF range. Battery is low	Move the instrument closer to a working controller or reader. Perform the network searching function in Programming Mode. Move the instrument closer to a working controller or reader and Press [Y/+] Replace battery
Others		Turn the instrument off and on again. Consult RAE Systems Customer Service.

12 Alarm Signal Summary

Alarm Mode	When	LCD	Buzzer & LED
Over Range	100% LEL or 5% CO ₂ (low range) or 100%Vol CO ₂ (high range)		3 beeps per second
High Alarm	> high alarm setting		3 beeps per second
Low Alarm	> low alarm setting		2 beeps per second
Zero Drift	< 0 ppm		1 beep per second
Battery Low	< 3.2V		1 beep per minute
Battery Exhausted	< 3.1V		1 beep per second

13 Technical Support

To contact RAE Systems Technical Support Team:

Monday through Friday, 7:00AM to 5:00PM Pacific (US) Time

Phone (toll-free): +1 888-723-4800

Phone: +1 408-952-8461

E-mail: RAE-tech@honeywell.com

Web Site: www.raesystems.com, www.honeywellanalytics.com

Outside the Americas:

E-Mail: HAexpert@honeywell.com

Honeywell Analytics Ltd.

4 Stinsford Road

Nuffield Industrial Estate

Poole, Dorset, BH17 0RZ

United Kingdom

Tel: +44 (0) 1202 645 544

Fax: +44 (0) 1202 645 555

Honeywell Analytics

Elsenheimerstrasse 43

80687 München

Germany

Tel: +49 89 791 92 20

Fax: +49 89 791 92 43

Honeywell Analytics

ZAC Athélia 4 – 375 avenue du

Mistral

Bât B, Espace Mistral

13600 La Ciotat

France

Tel: +33 (0) 4 42 98 17 75

Fax: +33 (0) 4 42 71 97 05

Honeywell Analytics

P.O. Box-45595

6th Street

Musaffah Industrial Area

Abu Dhabi

UAE

Tel: +971 2 554 6672

Fax: +971 2 554 6672

Ordering Replacement Parts: If you need replacement parts, a list is available online: <http://www.raesystems.com>



RAE Systems by Honeywell
World Headquarters
3775 N. First St.
San Jose, CA 95134-1708 USA
Phone: 408.952.8200
Toll-Free: 888.723.4800
Fax: 408.952.8480

E-mail (technical support): RAE-tech@honeywell.com
Web Site: www.raesystems.com

WORLDWIDE SALES OFFICES

USA/Canada 1.877.723.2878
Europe +800.333.222.44/+41.44.943.4380
Middle East +971.4.450.5852
China +86.10.5885.8788-3000
Asia Pacific +852.2669.0828

Rev. C
October 2015
P/N D01-4027-000