



## LIMITED WARRANTY

All Redi-Flo products manufactured by GRUNDFOS are warranted to the original user only to be free of defects in material and workmanship for the following periods of time. Redi-Flo VFD and Redi-Flo4™ variable performance pumps: 18 months from the date of installation, but not more than 24 months from the date of manufacture; Redi-Flo2® pumps; 12 months from date of installation, but not more than 18 months from the date of manufacture, whichever comes first.

GRUNDFOS' liability under this warranty shall be limited to repairing or replacing at GRUNDFOS' option, without charge, F.O.B. GRUNDFOS' factory or authorized service station, any product of GRUNDFOS manufacture. GRUNDFOS will not be liable for any costs of removal, installation, transportation, or any other charges which may arise in connection with a warranty claim. Products which are sold but not manufactured by GRUNDFOS are subject to the warranty provided by the manufacturer of said products and not by GRUNDFOS' warranty. GRUNDFOS will not be liable for damage or wear to products caused by abnormal operating conditions, accident, abuse, misuse, unauthorized alteration or repair, or if the product was not installed in accordance with GRUNDFOS' printed installation and operation instructions.

To obtain service under this warranty, contact the Distributor or Dealer from which it was purchased to obtain instructions. **Under no circumstances should defective product be returned to the Distributor, Dealer, or GRUNDFOS without a Return Materials Authorization (RMA).**

GRUNDFOS WILL NOT BE LIABLE FOR ANY INCIDENTAL OR CONSEQUENTIAL DAMAGES, LOSSES, OR EXPENSES ARISING FROM INSTALLATION, USE, OR ANY OTHER CAUSES. THERE ARE NO EXPRESS OR IMPLIED WARRANTIES, INCLUDING MERCHANTABILITY OR FITNESS FOR A PARTICULAR PURPOSE, WHICH EXTEND BEYOND THOSE WARRANTIES DESCRIBED OR REFERRED TO ABOVE.

Some jurisdictions do not allow the exclusion or limitation of incidental or consequential damages and some jurisdictions do not allow limitations on how long implied warranties may last. Therefore, the above limitations or exclusions may not apply to you. This warranty gives you specific legal rights and you may also have other rights which vary from jurisdiction to jurisdiction.

# Redi-Flo Variable Performance Pumps

## *Installation and Operating Instructions*

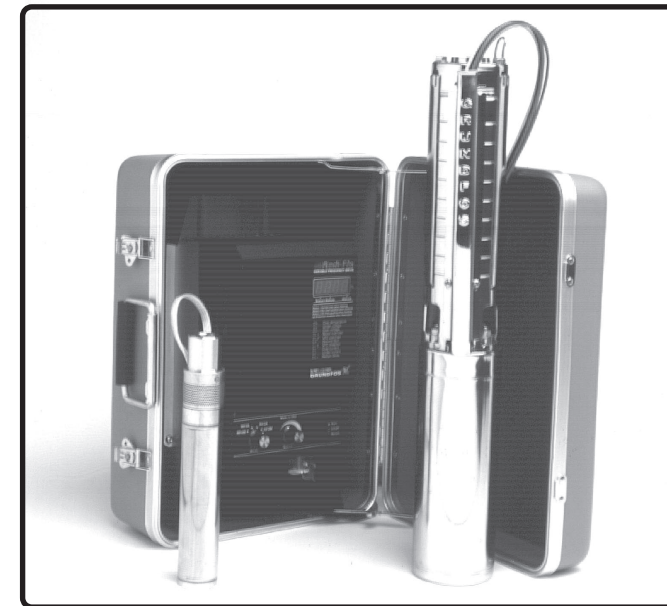

***Please leave these instructions with the Redi-Flo equipment for future reference***



Grundfos Pumps Corporation • 3131 N. Business Park Ave., Fresno, CA 93727  
Customer Service Centers: Allentown, PA • Fresno, CA  
Phone (800) 333-1366 • Fax (800) 333-1363  
Canada: Oakville, ONT • Mexico: Apodaca, N.L.  
Visit our website at [www.us.grundfos.com](http://www.us.grundfos.com)



L-RF-IO-006 06/00  
PRINTED IN USA



## SAFETY WARNING

### Electrical Work

Before beginning installation procedures, these installation and operating instructions should be studied carefully. All electrical work should be carried out by a qualified electrician in accordance with the latest edition of the National Electrical Code(NEC), local codes and regulations.

### Adherence To Environmental Regulations

When handling and operating the Redi-Flo Variable Performance Pump system, all environmental regulations concerning the handling of hazardous materials must be observed. When the pump is taken out of operation, great care should be taken to ensure that the pump contains no hazardous materials that might cause injury to human health or to the environment.

### Returning a Pump for Service

Only pumps that are certified as uncontaminated will be accepted by GRUNDFOS for servicing. GRUNDFOS must receive this certification prior to receiving the pump. If not, GRUNDFOS will refuse to accept delivery of the pump. In these cases, all costs incurred in returning the product to the customer will be paid by the customer. Contact your distributor for details on returning Redi-Flo products for servicing.

### Electrical Hazards

The Redi-Flo Variable Performance Pump system is not approved for Class 1, Division 1, Group D locations as specified by the National Electrical Code (NEC). Consult local authorities and regulations if you have any doubt about its suitability for a specific application.

#### WARNING

Hazard of Electric Shock: Do not expose the Redi-Flo Variable Frequency Drive (VFD) to moisture. If unavoidable exposure to moisture occurs, disconnect the electrical supply power immediately and have the unit inspected by an authorized service center to insure all safety features of the unit are in tact. To reduce the risk of electrical shock during operation of this Redi-Flo product, extreme care should be taken to ensure adequate grounding. All Redi-Flo products are provided with grounding provisions which comply with NEC guidelines. Always verify power source is properly grounded and there is a solid ground connection between the power source and the Redi-Flo VFD before energizing. If the means of connection to the supply power source is other than grounded metal conduit, ground the Redi-Flo VFD back to the service by connecting a copper conductor, at least the size of the circuit supplying the Redi-Flo VFD, to the grounding screw/terminal provided within the wiring compartment of the Redi-Flo VFD.

## TECHNICAL SPECIFICATIONS

### Redi-Flo Variable Frequency Drive (Type: SI/MP1-115/230V)

ELECTRIC	
<b>Input</b>	115V +/- 10% / 1 PH / 48-62 Hz / 23A 230V +/- 10% / 1 PH / 48-62 Hz / 23A
<b>Output with 115V Input</b>	1.5 kw / 400 Hz / 220V / 3 PH / 5.5A (RF2) 1.5 kw / 80 Hz / 230V / 3 PH / 5.5A (RF4)
<b>Output with 230V Input</b>	1.5 kw / 400 Hz / 220V / 3 PH / 5.5A (RF2) 2.0 kw / 100 Hz / 230V / 3 PH / 6.7A (RF4)
<b>Overload Rating</b>	5.5A for 1 minute (RF2) 7.5A for 1 minute (RF4)
<b>Acceleration Time (factory preset)</b>	0 to 400 Hz: 5 seconds (RF2) 0 to 100 Hz: 5 seconds (RF4)
<b>Deceleration Time (factory preset)</b>	400 to 0 Hz: 5 seconds (RF2) 100 to 0 Hz: 5 seconds (RF4)
<b>Recommended Input Protection (115V)</b>	Fuse, 1 each, 250V, 25A, UL Class RK1 or circuit breaker, 25A/300V/1P
<b>Recommended Input Protection (230V)</b>	Fuse, 2 each, 250V, 25A, UL Class RK1 or circuit breaker, 25A/300V/2P
<b>Power Cord</b>	SJTW, 14 AWG, 10', NEMA PH-185 Plug
<b>Output Ground Fault Protection</b>	Built-in (1000 mA)
<b>Minimum Frequency (factory preset)</b>	115 or 230V 25 Hz
<b>Maximum Frequency (factory preset)</b>	115 or 230V 400 Hz (RF2) 115V 80 Hz* (RF4) 230V 100 Hz (RF4)
<i>*Auto Frequency Limiting</i>	
DIMENSIONS AND WEIGHT	
<b>Dimensions</b>	Protective case is 9"x14"x18 1/2" VFD Only - 6" x 7 1/2" x 10 1/2"
<b>Net Weight (VFD, Cord &amp; Case)</b>	20 lbs. (10 1/2 lbs. - VFD only)
OPERATING CONDITIONS VFD ONLY	
<b>Ambient Temperature</b>	14°F to 120°F (-10°C to 50°C)
<b>Elevation</b>	Up to 3,300 ft. without derating
STORAGE CONDITIONS	
<b>Ambient Temperature</b>	-4°F to 140°F (-20°C to 60°C)
<b>Relative Humidity</b>	95%, Non-condensing
PROTECTIVE CASE CONSTRUCTION	
<b>Case</b>	High density polyethylene
<b>Trim</b>	Aluminum
<b>Lock</b>	Military twist type, steel with zinc plating
MINIMUM GENERATOR SIZE	
<b>Redi-Flo2®</b>	
<b>For Generators with Voltage Regulation</b>	2500 Watts at 115/230 VAC, single phase
<b>For Generators without Voltage Regulation</b>	5000 Watts at 115/230 VAC, single phase
<b>Recommended For Optimal Performance</b>	4000 Watts at 115/230 VAC, single phase with voltage regulation.
<b>Redi-Flo4™</b>	
<b>For Generators with Voltage Regulation</b>	3400 Watts at 115/230 VAC, single phase
<b>For Generators without Voltage Regulation</b>	6700 Watts at 115/230 VAC, single phase
<b>Recommended For Optimal Performance</b>	5400 Watts at 115/230 VAC, single phase with voltage regulation.

Note: RF2 = Redi-Flo2® RF4 = Redi-Flo4™

## TECHNICAL SPECIFICATIONS

### Redi-Flo2® Pump & Motor

ELECTRIC	
Full Load Rating	.5 HP / 220V / 3 PH / 400 Hz / 5.5A
Maximum Current (SFA)	5.5 amps
Motor Protection	Thermal overload - Thermik Geratebau, Series SY6 - (176°F [80°C]) Current Overload - Incorporated into Redi-Flo VFD (9.0A for 10 seconds)
PIPING CONNECTION	
Discharge Port	½" Female NPT
OPERATING CONDITIONS	
Minimum Ambient Fluid Temperature	34°F (1°C)
Maximum Ambient Fluid Temperature	80°F (28°C)
MOTOR FLUID	
Motor Lubricating Fluid	Deionized (DI) Water
STORAGE CONDITIONS	
Minimum Ambient Temperature	34°F (1°C)
Maximum Ambient Temperature	120°F (50°C)
DIMENSIONS AND WEIGHT (PUMP AND MOTOR)	
Dimensions	11.3" length x 1.81" diameter
Net Weight	5.5 lbs., excluding motor lead
LEAD LENGTHS	
Standard Lengths in Feet	30, 50, 75, 100, 125, 150, 175, 200, 250, 300
Custom Lengths	Available in 1 ft. increments from 30 to 300 ft.

## TECHNICAL SPECIFICATIONS

### Redi-Flo4™ Variable Performance Pump & Motor

ELECTRIC	
Full Load Rating	2.0 HP / 230V / 3 PH / 60 HZ / 6.7A
Service Factor	1.25
Maximum Current (SFA)	7.5 amps
Motor Protection	Redi-Flo VFD supplies protection for motor Motor has no internal protection
PIPING CONNECTION	
Discharge Port	5E8 -- 1" Female NPT 10E5 -- 1 ¼" Female NPT 16E4 -- 1 ¼" Female NPT 25E3 -- 1 ½" Female NPT
OPERATING CONDITIONS	
Minimum Ambient Fluid Temperature	34°F (1°C)
Maximum Ambient Fluid Temperature	104°F (40°C)
STORAGE CONDITIONS	
Motor Fluid	Deionized (DI) water with 30% propylene glycol
STORAGE CONDITIONS	
Minimum Ambient Temperature	-4°F (-20°C)
Maximum Ambient Temperature	120°F (50°C)
DIMENSIONS AND WEIGHT (PUMP AND MOTOR)	
5E8	26 ¾" (length) 37 lbs.
10E5	23 ¾" (length) 35 lbs.
16E4	22 ⅞" (length) 34 lbs.
25E3	22" (length) 34 lbs.
Maximum Diameter	3 ⅜"
LEAD LENGTHS*	
Standard Lengths in Feet (25 ft. increments)	25' to 600' All models

\*With Redi-Flo4™ Variable Performance Pumps, you must have an adapter cord to connect to Redi-Flo VFD. See page 29, Parts, and Accessory List, Redi-Flo VFD x RF4 Variable Performance Pump section.

## REDI-FLO VFD SPECIAL FEATURES

### Redi-Flo Variable Frequency Drive

For more detailed information on the following features, see Operator Adjustments and Redi-Flo VFD Inputs & Outputs on page 11-12 and 15-16).

#### Dual Input Capability

Redi-Flo VFD can accept 115V or 230V input voltage available in one unit

#### Enclosure

The Redi-Flo VFD NEMA 1 enclosure is designed to provide a degree of protection against personnel contact with the internal electrical components. Care must be used to prohibit moisture from coming into contact with the unit.

#### UL Approvals

The Redi-Flo VFD is UL Listed to U.S. and Canadian electrical safety standards.

#### 10-Turn Potentiometer

The Redi-Flo VFD is equipped with a "10-Turn Pot" for finer adjustment of motor speed and pump performance.

#### Dual Functionality

The Redi-Flo VFD can change from operating Redi-Flo2® (MP1) to Redi-Flo4™ Variable Performance pumps with a turn of a dial.

#### Output Ground Fault Protection

Built-in ground fault sensing for protection of Redi-Flo VFD and down hole equipment.

#### Grundfos Repairable

The Redi-Flo VFD can be repaired at all Grundfos Customer Service Centers for fast turn-around.

#### Dry Run Protection (Input Undercurrent Trip)

The Redi-Flo VFD can protect pumping equipment from damage as a result of "dry run" / "pump off" conditions at frequencies above 50 HZ for Redi-Flo4™ and above 300 HZ for Redi-Flo2®. This feature can be further configured for automatic restart of the Redi-Flo VFD after a time period adjustable from 1 to 99 minutes.

#### Output Frequency Limited by Input Current

The output frequency is clamped when the input current reaches 16.0 amps, regardless of input voltage. The clamped output frequency prevents overload of 20 amp circuit breaker and portable 115V generator sets.

#### Torque Boost

The Redi-Flo VFD is equipped with an adjustable torque boost (voltage boost) feature to aid in start-up under severe conditions.

#### Optimized Volts/Frequency (V/HZ) Pattern

The Redi-Flo VFD V/f pattern is specially optimized to allow the most efficient operation of Redi-Flo2® and Redi-Flo4™ variable performance pumps.

## REDI-FLO VFD SPECIAL FEATURES

### External Speed Reference Signal Following Capability

The Redi-Flo VFD will follow an external 4-20 mA speed reference signal when the mode selector dial is switched from Manual to Automatic Operation (RF2A and RF4A).

### Isolated 24 Volt DC Power Supply

The Redi-Flo VFD is equipped with an isolated 24 VDC-100 mA power supply for use as a loop power source for an external 4-20mA transducer (transmitter) or flowmeter.

### On/Off Control Terminals

The Redi-Flo VFD provides easy connection of liquid level controls for on/off operation.

### Auxiliary Contacts

1. Redi-Flo VFD run acknowledge: contact closed when Redi-FloVFD is powered and ready for operation (i.e., RSR switch in run position).
2. Redi-Flo VFD fault annunciation: "Form C" contacts closes upon fault. Annunciated faults are over temperature (OH), under voltage(UU), over voltage(OV), motor overload (OL1), VFD overload (OL2), ground fault (GF), over current (OC), and under current (UC), under current 1 (UC1) under current restart (UCr).
3. Speed reached acknowledge: contact closed when Redi-Flo VFD has reached the speed/frequency set on the 10-turn potentiometer. Typically used to enable external timers or counters.

**NOTE:** All contacts rated 2A at 250 VAC/30 VDC.

### Frequency/Fault/Status Display

The Redi-Flo VFD has an easy to read, 3/4" high-7segment LED, frequency display and fault annunciation. A four (4) place digital frequency display (XXX.X) and fault code annunciation ensure precise adjustment and easy diagnostics. See Troubleshooting section, pages 17-18.

## PRE-INSTALLATION CHECKLIST

### Components of Your Redi-Flo VFD System

Your Redi-Flo Variable Performance Pump system should contain the following components:

1. Redi-Flo Variable Frequency Drive, SI/MP1-115/230V (See Figure 1)
2. Either a Redi-Flo2® pump and motor with lead (Figure 2) or a Redi-Flo4™ Variable Performance pump, motor, lead,lead/plug and RF4 x VFD adapter cord (Figure 3).

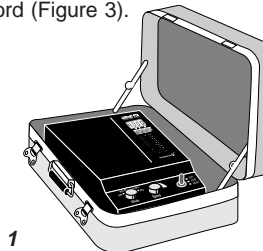

Figure 1

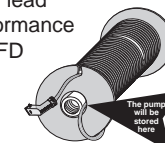

Figure 2

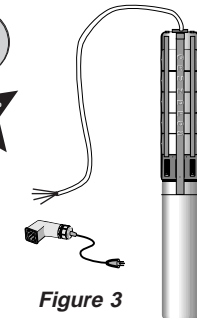

Figure 3

## PRE-INSTALLATION CHECKLIST

### To operate the system you will also need:

1. A discharge hose or pipe to connect to the pump (See Figure 4).
2. An electrical plug to connect the Redi-Flo VFD power cord to your portable generator may be needed if the supplied plug is not compatible with your generator (See Figure 5).
3. Safety cable and hardware for lowering and lifting the pump (See Figure 6).

Figure 4

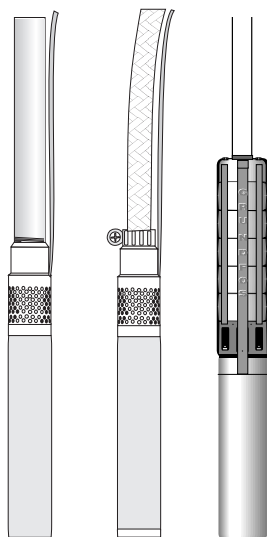
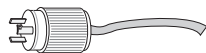
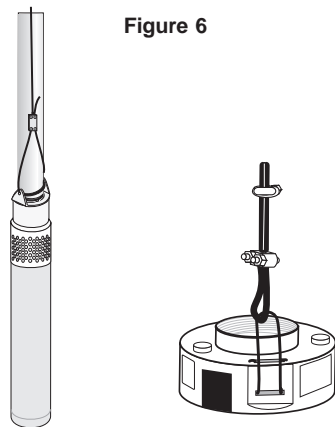

Figure 5



The exact type of plug used will depend upon your generator. The Redi-Flo VFD is supplied with a standard NEMA, 115V, 3 prong plug.

Figure 6



Redi-Flo2®

Redi-Flo4™

## ASSEMBLING THE REDI-FLO VFD SYSTEM

### SAFETY WARNING

All electrical work should be performed by a qualified electrician in accordance with the latest edition of the National Electrical Code, local codes and regulations.

Unpack the components of the Redi-Flo Variable Performance System. With Redi-Flo2® pumps, the pump will be packed in the center of the motor lead spool as shown on page 6, Figure 2. Make sure that you have the correct pump for the installation. If you purchased a Redi-Flo4™ pump in component form, see instructions on pages 25-26, and refer to the Redi-Flo4™ Installation guide for assembly instructions.

### Attaching the Pump to the Pipe

When connecting piping to the pump, a back-up wrench should be used. Redi-Flo4™ pumps should only be gripped by the flats near the top of the discharge chamber. Under no circumstances grip the body of the pump, cable guard or motor. When tightened down, the threaded end of the first section of riser pipe or nipple must not come in contact with the check valve retainer in the discharge chamber of the pump. After the first section of pipe has been attached to the pump, the safety cable should be connected to the pump (as shown in figure 6). Do not clamp to the pump. When raising the pump, be careful not to place bending stress on the pump by picking it up by the pump end only. A safety cable should be attached to the pump (using special brackets and cables, sold separately) anytime plastic pipe or flexible tubing is used. A check valve may also be added to Redi-Flo2® pumps to prevent fluid from flowing back into the pump after it is turned off (backflow prevention). A check valve is standard on Redi-Flo4™ pumps. Always check to ensure joints are fastened securely. The use of a torque arrester is not required when using the Redi-Flo VFD.

### Attaching Redi-Flo lead to well plug pigtail

The Redi-Flo4 is supplied with a special well plug and submersible lead splice kit.



## INSTALLATION AND OPERATION FOR THE REDI-FLO VFD SYSTEM

### Lowering the Pump Into the Well

Make sure the electrical motor leads are not cut or damaged in any way when the pump is being lowered into the well. Do not use the motor leads to support the weight of the pump.

To protect against surface water entering the well and contaminating the well, the well should be finished off utilizing a locally approved well seal, unit or a Grundfos Redi-Flo well seal.

The motor lead should be secured to the discharge pipe at frequent intervals to prevent sagging, looping and possible motor lead damage. Teflon® wire ties are recommended for environmental applications.

#### IMPORTANT

Plastic pipe and tubing tend to stretch under load. This stretching must be taken into account when securing the motor lead to the riser pipe or tubing. Leave three to four inches of slack between clipped points. This tendency to stretch will also affect the calculation of the pump setting depth. When plastic pipe or tubing is used, it is recommended that a safety cable be attached to the pump to raise and lower it. Redi-Flo4™ pumps are designed to accommodate this cable and Redi-Flo2® pumps can be fitted with a safety cable bracket (part number 1A0019).

### Operating Conditions

To ensure the Redi-Flo Variable Performance Pumping system operates properly, follow these guidelines:

- The Redi-Flo2® or Redi-Flo4™ pump must be installed vertically with the discharge end pointed upwards.
- The electrical voltage supply to the Redi-Flo VFD must always be within + or - 10% of the specified power supply ( 103.5 - 126.5 VAC at 115V settings or 207 - 253 VAC at 230V ).
- For best performance when operating on a generator, 115V generators should be set at 120V without load and 230V generators should be set at 240V without load. Use a separate meters to set voltage; do not rely on built-in meters on generators.
- The pump and motor must always be completely submerged in fluid to ensure lubrication and cooling of the motor.
- The temperature of the fluid being pumped should be according to the technical specifications (Pages 3-4).
- The installation depth of the pump should always be at least three feet below the maximum drawdown level of the well.
- Redi-Flo pumps are not recommended for well development or pumping fluid containing abrasives.
- Redi-Flo2® pumps are not recommended for continuous operation applications.
- The warranty of the Redi-Flo pumps will be void if other than the Redi-Flo, is used or if corrosive fluids are pumped.
- The service life of dedicated Redi-Flo pumps may be compromised if the ambient water quality exceeds one or more of the following values:

$pH < 5$     $DO > 2 \text{ ppm}$     $H_2S > 1 \text{ ppm}$     $CL \rightarrow > 500 \text{ ppm}$     $TDS > 1000 \text{ ppm}$

## ASSEMBLING THE REDI-FLO VFD SYSTEM

### Starting

To operate the Redi-Flo VFD system, simply:

1. Submerge the RF2 or RF4 pump in the water to be pumped.

#### #2 and #3 for operation with generator only.

2. If using a generator, start the generator and allow it to warm up.

Figure 7

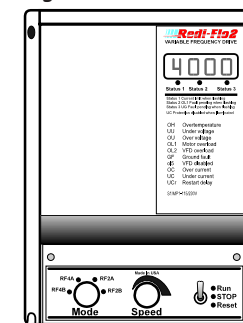

S/MP1  
Front  
Panel

3. If the generator has a circuit breaker, close the breaker and check the output voltage from the generator. The output voltage must be within the specified ranges (refer to Technical Specifications, page 2) to ensure proper operation and prevent damage to the system. If the voltage is too high or too low, adjustments to the generator must be performed to allow the system to run.

4. Plug the Redi-Flo VFD into the generator or connect to power supply in accordance to the National Electric Code, and/or local ordinance.

5. Select RF4M (Redi-Flo4™ manual operation) or RF2M (Redi-Flo2® manual operation) with the Mode selection knob, depending on the pump to be operated.
6. Connect the motor lead to the Redi-Flo VFD. (Note: With RF4 Variable Performance Pumps you must have an adapter cord to connect to Redi-Flo VFD). See page 29, Parts List, Redi-Flo VFD x RF4 Variable Performance Pump Accessories section.
7. Check the frequency display on the Redi-Flo VFD. It should read "0.0" (zero). If it doesn't, refer to the Troubleshooting section on page 17-18.
8. If this is the first time the Redi-Flo VFD is being used or it has not been used for more than six months, leave the Redi-Flo VFD on for at least 5 minutes before proceeding to the next step.
9. Set the Redi-Flo VFD speed dial to the desired performance. If unknown, it is recommended to turn the speed dial completely counter clockwise to lowest speed setting and then adjust up after starting.
10. Start the pump by switching the Redi-Flo VFD run/stop/reset (RSR) switch to run.
11. Adjust the pump performance to the desired level by turning the speed dial (10-turn potentiometer) until the desired performance is attained.

### Stopping

To stop the pump, switch the RSR switch to stop. It is not necessary to reduce the speed of the motor before switching the RSR switch to stop. You should unplug the Redi-Flo VFD from the generator BEFORE removing the motor lead from the Redi-Flo VFD or turning off the generator.

## ASSEMBLING THE REDI-FLO VFD SYSTEM

### Purging A Well

If the pump is used to purge a well, start the pump at minimum speed and gradually increase to maximum speed. Do not stop the pump until the pumped fluid contains no visible particles (to avoid blockage within the pump). Redi-Flo products are not recommended for well development.

## REDI-FLO VFD OPERATOR ADJUSTMENTS

**Operator Adjustable Control Features for Custom Operation**  
(See flowchart on page 14 for steps required to adjust parameters. Parameter list shows function no., description, range, and factory preset default settings)

**F00-RF2 MAXIMUM FREQUENCY (FMAX):** Factory preset at 400HZ for Redi-Flo2® pumps. Maximum frequency is adjustable from 400-100HZ. To adjust maximum frequency follow the steps on the flowchart on page 14.

**F01-RF2 MINIMUM FREQUENCY (FMIN):** Factory preset at 25HZ for the Redi-Flo2® pumps. Minimum frequency is adjustable from 0-100HZ. To adjust minimum frequency follow the steps on the flowchart on page 14.

**F02-RF4 MAXIMUM FREQUENCY (FMAX):** Factory preset at 100HZ for Redi-Flo4™ variable performance pumps. Maximum frequency is adjustable from 0.0-100HZ. To adjust maximum frequency follow the steps on the flowchart on page 14.

**F03-RF4 MINIMUM FREQUENCY (FMIN):** Factory preset at 25HZ for Redi-Flo4™ variable performance pumps. Minimum frequency is adjustable from 0-30HZ. To adjust minimum frequency follow the steps on the flowchart on page 14.

**F04-ACCELERATION TIME (ACCEL):** Factory preset at 5 seconds. Acceleration time is adjustable from 0.5-10 seconds. To adjust acceleration time follow the steps on the flowchart on page 14.

**F05-DEACCELERATION TIME (DECCEL):** Factory preset at 5 seconds. Deacceleration time is adjustable from 0.5-10 seconds. To adjust deacceleration time follow the steps on the flowchart on page 14.

**F06-TORQUE BOOST(BOOST):** Torque Boost is used to increase startup torque at low speeds. Factory preset at zero. Torque Boost is adjustable from 0-30%. To adjust follow the steps on the flowchart on page 14.

## SI/MP1 REDI-FLO VFD OPERATOR ADJUSTMENTS

**F07-BASE FREQUENCY(MAINS F):** Factory preset at 60HZ. Base Frequency is adjustable to 50HZ or 60HZ. To adjust base frequency follow the steps on the flowchart on page 14.

**F08-MOTOR OVERLOAD(IXT LEVEL):** Factory preset at 110%. The Redi-Flo VFD will trip after 1 minute when output current exceeds 5.5A for Redi-Flo2® pumps and 7.5A for Redi-Flo4™ pumps. The motor overload is adjustable from 50-110%. To adjust motor overload trip current, follow the steps on the flowchart on page 14.

**F09-UNDERCURRENT(UC ENABLE):** Factory preset at (0) disabled. Input under current detection level is adjustable either to (0) disabled or (1) enabled. To adjust UC level, follow the steps on the flowchart on page 14.

**F10-INPUT UNDERCURRENT LEVEL(UC LEVEL):** Factory preset at 30%. Input undercurrent detection level is adjustable from 10-60%. The input undercurrent trip level is adjustable from 1.6-9.6A. To adjust detection level, first enable (F09) then adjust level (F10) by following the steps on the flowchart on page 14.

\*\*The Redi-Flo VFD can protect pumping equipment from damage as a result of "dry running" at frequencies above 50Hz for the Redi-Flo4™ or above 300Hz for the Redi-Flo2®.

**F11-INPUT UNDERCURRENT RESTART TIME(UC TIME):** Factory preset at 1 minute. Input undercurrent restart time is adjustable from 1-99 minutes. The Redi-Flo VFD can be set to restart automatically after it has cut out on input under current trip (UC). After a set period of time (1-99 minutes) the Redi-Flo VFD can be set up to restart automatically or it can be set not to restart until manually reset. **If (F11) is set at zero then there is no automatic restart.** To adjust restart time follow the steps on the flowchart on page 14.

**F12-SWITCHING FREQUENCY(MODULATION):** Factory preset at 1(7.8 kHz). Switching frequency is adjustable from 0 (15.6 kHz), 1 (7.8 kHz) or 2 (3.9 kHz). To adjust switching frequency follow the steps on the flowchart on page 14.

**F13-INPUT CURRENT ENABLE:** Factory preset at 0 (disabled). Input current is adjustable from 0 (disabled, 23 A) or 1 (enabled, 16A). To adjust, input current follow the steps on the flowchart on page 14.

**F14-AUTO REFERENCE SIGNAL:** Factory preset at 0 (disabled). Auto Reference Signal is adjustable from 0 or 1 enabled. To adjust Auto Reference Signal follow the steps on page 14.

**F15-NO MOTOR LOAD(UC1):** Factory preset at 1 (enabled). No motor load is adjustable from 0 (disabled) or 1 (enabled). To adjust No Motor Load follow steps on Page 14.

## PARAMETER LIST FOR REDI-FLO VFD OPERATOR ADJUSTMENTS

### CAUTION

**The internals of the Redi-Flo VFD contain High Voltages! Extreme caution should be exercised when making adjustments.**

**Note: Shaded functions can be changed during operation.**

NO.	DESCRIPTION	RANGE	UNITS	DEFAULT
F00	RF2 Max. Output Frequency	100.0-400.0 Hz	1.0 Hz	400.0 Hz
F01	RF2 Min. Output Frequency	0.0-100.0 Hz	1.0 Hz	25.0 Hz
F02	RF4 Max. Output Frequency	30.0-100.0 Hz	1.0 Hz	100.0 Hz
F03	RF4 Min. Output Frequency	0.0-30.0 Hz	1.0 Hz	25.0 Hz
F04	Acceleration Time (to 100/400 Hz)	0.5-10.0 Sec.	0.5 Sec.	5.0 Sec.
F05	Deceleration Time (from 100/400 Hz)	0.5-10.0 Sec.	0.5 Sec.	5.0 Sec.
F06	Torque Boost (in % max.)	0-30%	1%	0%
F07	Base Frequency Select	50 or 60 Hz	Hz	60 Hz
F08	Motor Overload Level Im depends upon RF2/RF4	50-110% Im	%Im	110%
F09	Input Undercurrent Detection Disable 0= Disabled 1= Enabled	0-1		0 (Disabled)
F10	Input Undercurrent Detection Level	10-60% (1.6-9.6A)	%Im	30%
F11	Input Undercurrent Restart Time	1-99 mins.	1 min.	1 min.
F12	Switching Frequency 0= 15.6 kHz 1= 7.8 kHz 2= 3.9 kHz	0-2	-	1 (7.8kHz)
F13	Input Current Enabled 0= Disabled (23A) 1= Enabled (16A)	0-1	-	0 (Disabled) 23A
F14	Auto Reference Signal 0= Disabled 1= Enabled	0-1	-	0 (Disabled)
F15	No Motor Load 0= Disabled 1= Enabled	0-1	-	1 (Enabled)

**To Adjust Operator Adjustable Control Features, follow the following instructions:** (See Figure 8)

1. Disconnect Redi-Flo VFD from the power supply.
2. Remove front cover of VFD by loosening the two Phillips head screws.
3. Lift and set aside the cover to expose the mode keys in the center of the drive. Use caution to avoid damage to the ribbon cable attaching the front cover to the interior of the drive.
4. Setting aside the front cover place in a position so the LED display is visible.
5. Connect drive to the power supply.
6. Use the following flow chart to adjust operator adjustable control features.

## OPERATOR ADJUSTABLE CONTROL FEATURES

Figure 8

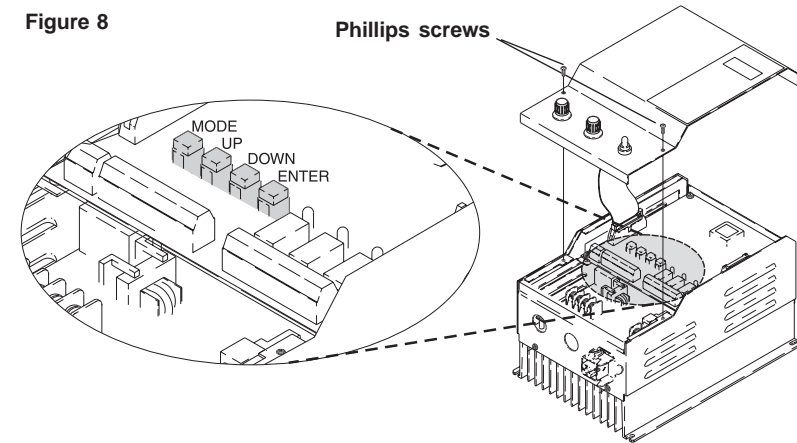

Use flowchart below to change operator adjustable control features.

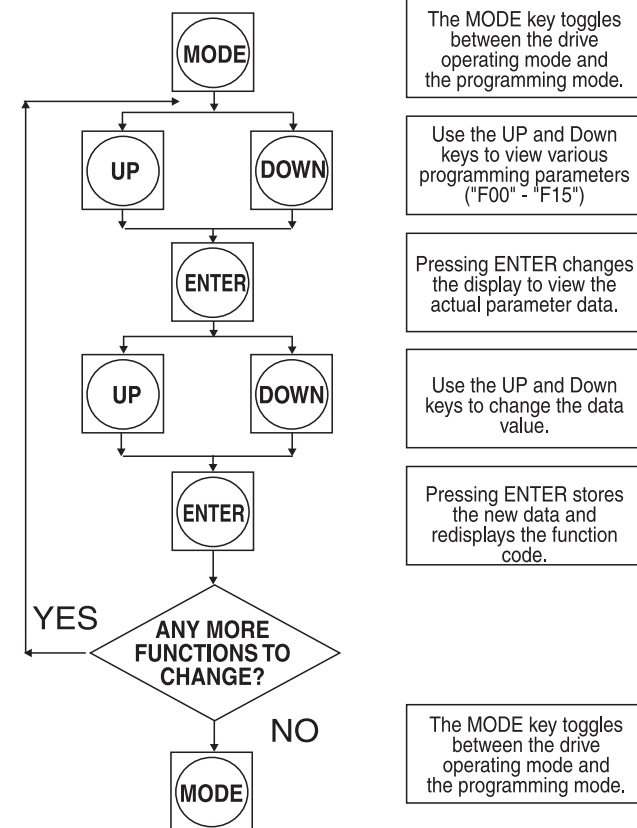

## REDI-FLO VFD ELECTRICAL INPUT/OUTPUT

### Input Power Terminals

The Input voltage can be changed between 115V and 230V by changing the line input connections as shown in Figure 9 below.

CAUTION !

**WARNING-** If the Redi-Flo VFD is miswired for the incoming voltage internal damage may occur to the drive!  
 This drive contains possibly lethal AC voltage when AC power is connected. Switching the Redi-Flo variable frequency drive switch to STOP does not remove AC line voltage. All input phases must be disconnected before it is safe to touch motor terminals or control equipment parts. Lethal voltage may be present up to 2 minutes after disconnecting from power source. To change Input/Output line connections, first make sure that input power is turned off and Redi-Flo VFD is disconnected. Then remove the Redi-Flo VFD cover and wire for 115V or 230V.

**115V**

L1	L2	L3	GND
White	Black	Green (Ground)	

**230V**

L1	L2	L3	GND
White	Black	Green (Ground)	

*Figure 9:*

### Output Power Terminals

Redi-Flo VFD output terminals are to be terminated into the Harting connector per Figure 10 below:

*Figure 10:*

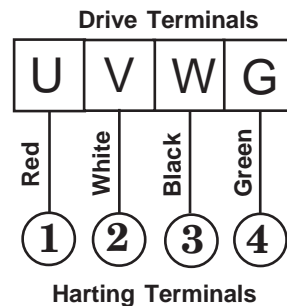

## REDI-FLO VFD AUXILIARY INPUT/OUTPUT

To access output terminals refer to page 13 steps 1-2

*Figure 11: Diagram of input and output terminals located on top circuit board (behind cover)*

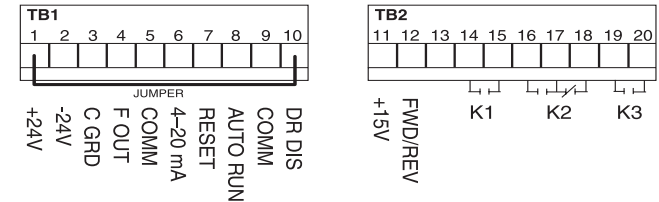

- **24VDC:** 100mA power supply to power external process loop. To connect to this supply, connect to terminals 1 and 2 as labeled in Figure 11.
- **0 - 10V External speed (frequency) reference:** To connect a 0-10V (0-1 mA) external speed reference device, (Yokogawa Model # 251-320-MTMT or equivalent), connect to terminals 4 and 9 as labeled in Figure 11.
- **4 - 20 mA Input signal:** Can be used to control the Redi-Flo VFD. To set the Redi-Flo VFD to follow a 4-20 mA input signal from a control device, connect to terminals 5 and 6 as shown in Figure 11. The mode selection knob must also be turned to the appropriate automatic mode, RF2A or RF4A depending on the pump being used. A jumper is required between terminals 8 and 11, and enable Operator Adjustable Control feature Auto Reference signal(F14) see Page 12-14.
- **RST Auxiliary fault reset (reset):** An auxiliary fault reset momentary contact between terminals 7 and 11 as labeled in Figure 11.
- **AUTO RUN Automatic run permissive:** A jumper must be placed between terminal 8 and 11 as labeled in Figure 11, for automatic 4 - 20 mA speed reference signal following capability. A jumper between terminals 8 and 11 does not affect manual operation.
- **DR DIS Drive enable/disable terminal:** A switching device can be added to this normally closed (jumpered) terminal giving an external enable/disable option. When these terminals are opened during operation the unit coasts to a stop. The unit ramps up when terminals are closed. This jumper is wired from terminal 1 to terminal 10, as labeled in Figure 11.
- **FWD/REV Pump rotation:** Direction can be reversed externally by connecting a switching device or jumper to terminals 11 and 12 as labeled in Figure 11. Open is normal rotation and closed is reverse rotation.
- **Run/Fault Signal outputs:** Contact ratings, 2A @ 250V/30VDC
  - K1-Redi-Flo VFD Speed Reached Output: Normally open contact between terminals 14-15, to close when Redi-Flo VFD is in run mode and speed dial set frequency is reached.
  - K2-Redi-Flo VFD No Fault/Fault Output: Normally open and normally closed contacts terminals 17-18. Relay to energize upon application of power. The N.O. and N.C. contacts will change state when fault occurs.
  - K3-Redi-Flo VFD Run Acknowledge Output: Normally open contact terminals 19-20 to close when Redi-Flo VFD is in run mode and there is output current.

## TROUBLESHOOTING

The Redi-Flo VFD can indicate the presence of a pending fault by the use of status lights on the digital readout display see Figure 13 below.

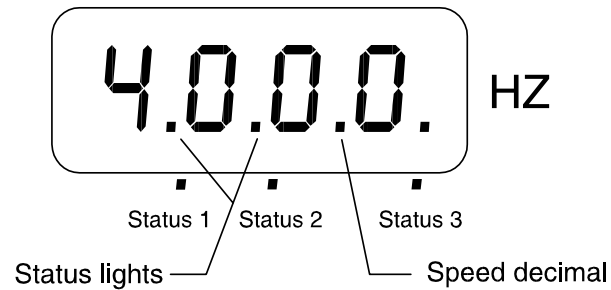

Figure 13

## Status Lights

### Status 1

- Flashing: Input Current limit has been reached. Even if speed dial is turned to increase speed, the speed is locked and will not rise.

### Status 2

- Flashing: Motor Overload fault is pending. Motor current has exceeded maximum allowed current (5.5A-RF2 & 7.5A-RF4) and Redi-Flo VFD will trip on an overload (OL1) fault in 60 seconds if speed is not turned down (load reduced).

### Status 3

- Flashing: Undercurrent fault is pending. If the speed is not turned down within 8 seconds, the Redi-Flo VFD will trip on an under current (UC) fault.
- Solid: Under current trip/fault is disabled.

## TROUBLESHOOTING

### Redi-Flo Variable Frequency Drive

The Redi-Flo VFD will display an fault if any major fault occurs.

If the display shows this:	The Fault is:	Which may be caused by:	Remedy:
OK	Over temperature	<ul style="list-style-type: none"> <li>The VFD is overloaded</li> <li>The VFD is thermally overloaded</li> <li>Defective VFD</li> </ul>	<ul style="list-style-type: none"> <li>Reduce the load by reducing the frequency</li> <li>Check that the VFD's max. amb. temp. is not exceeded and it has proper ventilation</li> <li>Have VFD checked by Grundfos technician</li> </ul>
UU	Under voltage	<ul style="list-style-type: none"> <li>Input voltage too low</li> <li>Input wire run too long</li> <li>Input wire size too small</li> <li>DC bus is charging</li> </ul>	<ul style="list-style-type: none"> <li>Reset the VFD, if it cuts out again, check voltage at VFD and power source to determine where voltage loss has occurred and increase voltage as needed</li> <li>Check input 120,230 voltage wiring termination</li> <li>Check input voltage</li> </ul>
OU	Over voltage	<ul style="list-style-type: none"> <li>Input voltage too high</li> </ul>	<ul style="list-style-type: none"> <li>Reset the VFD, if it cuts out again check voltage at power source and reduce voltage as needed</li> </ul>
OL1	Motor overload	<ul style="list-style-type: none"> <li>Motor drawing high amps (5.5A-RF2/7.5A-RF4)</li> <li>Locked rotor</li> <li>Defective motor</li> </ul>	<ul style="list-style-type: none"> <li>Check pump for blockage or excess wear, repair or replace as needed</li> <li>Check F08 operators adjustments on pg.13</li> </ul>
OL2	VFD overload	<ul style="list-style-type: none"> <li>The VFD is overloaded</li> <li>Defective VFD</li> </ul>	<ul style="list-style-type: none"> <li>Reduce the load by reducing the frequency</li> <li>Have VFD checked by Grundfos technician</li> </ul>
GF	Ground fault	<ul style="list-style-type: none"> <li>Motor is grounded</li> <li>Cable is damaged</li> <li>Transistor shorted</li> </ul>	<ul style="list-style-type: none"> <li>Check motor and lead with megohmmeter and repair or replace as needed. The insulation resistance must be greater than 1.5 M <math>\Omega</math>*</li> <li>Have VFD checked by Grundfos technician</li> </ul>
o15	VFD disabled	<ul style="list-style-type: none"> <li>Remote connection contact open</li> <li>Jumper between terminals 1-10 removed</li> </ul>	<ul style="list-style-type: none"> <li>Check external device operation</li> <li>Check Jumper</li> </ul>
OC	Over current	<ul style="list-style-type: none"> <li>Motor or motor lead defective/damaged</li> <li>VFD amp draw above 16A</li> <li>Defective motor</li> <li>Defective VFD</li> </ul>	<ul style="list-style-type: none"> <li>Reduce the frequency</li> <li>Check motor and lead with megohmmeter and repair or replace as needed. The insulation resistance must be greater than 1.5 M <math>\Omega</math>*</li> <li>Check pump for locked rotor condition</li> <li>Have VFD checked by Grundfos technician</li> </ul>
UC	Under current	<ul style="list-style-type: none"> <li>Pump running dry or shut off or at pump off</li> <li>Motor current below UC (F10)setting</li> </ul>	<ul style="list-style-type: none"> <li>Check water level, drawdown, pumping level and above ground pressure for these conditions</li> <li>Check pump for proper rotation</li> <li>Let motor cool and try to restart</li> </ul>
UCr	Restart delay	<ul style="list-style-type: none"> <li>Under current restart is pending</li> </ul>	<ul style="list-style-type: none"> <li>Pump will automatically restart after preset delay</li> <li>Set "0" on F11 to eliminate auto restart</li> </ul>
UC1	No Motor Load	<ul style="list-style-type: none"> <li>Motor is not connected</li> <li>Motor thermal is open</li> </ul>	<ul style="list-style-type: none"> <li>Check ambient fluid temperature</li> <li>Reduce motor load</li> <li>Connect motor to drive</li> </ul>

\*Do not use megohmmeter at Redi-Flo VFD output terminals.

## Dismantling & Reassembling Pump End

The Redi-Flo2® pump can be dismantled and reassembled quickly and easily by referring to the diagram on page 27 and following these steps:

### DISMANTLING

1. Shut the pump off by placing the Redi-Flo VFD RSR switch in the stop position.
2. Disconnect Redi-Flo VFD from power supply or generator.
3. Disconnect the motor lead from the Redi-Flo VFD.
4. Remove the pipe or tubing connected to the pump (OPTIONAL).
5. Remove the Set Screw (position 12 in the diagram on page 27). Grasp the Inlet Screen (position 1) and slowly but forcefully pull it up over the Pump Housing (position 2).

**DO NOT ALLOW THE INLET SCREEN TO SCRAPE THE INSULATION FROM THE MOTOR LEAD.**

6. Unscrew and remove the Pump Housing (counterclockwise when viewed from the top). This will expose the impeller assembly (guide vanes, wear rings, etc.), which can now be removed by hand for extended cleaning or replacement.

### REASSEMBLY

To reassemble the Redi-Flo2® pump, refer to the diagram on page 27 and:

1. Make sure the motor lead is not connected to the Redi-Flo VFD.
2. Return the impeller assembly components (guide vanes, wear rings, etc.) to the shaft in the proper order per impeller assembly diagram.
3. Screw the Pump Housing (position 2) back onto the top of the pump. If all of the impellers and chambers were replaced correctly, the Pump Housing should screw on easily. Hand tighten.
4. Slip the Inlet Screen (position 1) back over the Pump Housing. Screw the Set Screw (position 12) back into the Inlet Screen.

**MAKE SURE YOU LINE UP THE MOTOR LEAD WITH THE RECESSED AREA IN THE PUMP HOUSING TO AVOID SCRAPING THE INSULATION FROM THE LEAD**

## Dismantling & Reassembling Motor

If the pump is moved from well to well, it should be thoroughly decontaminated prior to being installed in the next well. In addition to cleaning the individual components inside and outside, the water in the pump motor should be replaced using the syringe that came with your pump. This can be accomplished through the following steps:

1. Shut the pump off by placing the Redi-Flo VFD RSR switch in the stop position.
2. Disconnect Redi-Flo VFD from power supply or generator.
3. Disconnect the motor lead from the Redi-Flo VFD.
4. Remove the discharge tubing and the pump end (follow dismantling procedure page 19).
5. Turn the pump and motor upside down.



6. Use a flat blade screwdriver to remove the filling screw on the bottom of the motor.
7. Remove the three Allen head set screws at the bottom of the motor with 2.5 mm Allen wrench.
8. Push gently on the motor shaft to move bearing housing out of the stator housing.



9. Continue to remove bearing housing and motor shaft from stator housing.
10. Clean motor shaft with a brush.
11. Empty the water from the motor.
12. Clean inside of stator housing with a brush.
13. Replace motor shaft into stator housing.
14. Refill motor using contaminant-free deionized water using the syringe that came with your Redi-Flo2® pump.

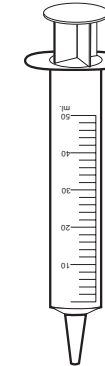

15. Replace bearing housing and tighten Allen screws.
16. Continue to add water until the level is even with the bottom edge of the screw hole.
17. Replace and tighten the filling screw.
18. Turn the pump over several times, then remove the filling screw again to let any trapped air escape (if air is left inside the motor, the life of the motor will be shortened). Add more water, as necessary. Fluid should overflow when the fill cap is screwed back on the motor cavity.
19. Replace and tighten the filling screw.
20. Replace pump end and piping (see reassembly page 19).

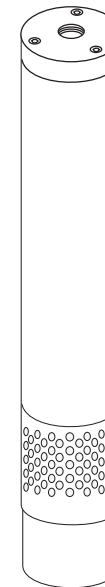

## Replacing the Motor Lead

To replace the motor lead, refer to the diagram on page 27 and follow these steps:

### REMOVING THE OLD MOTOR LEAD

1. Make sure the power is turned **OFF**, the Redi-Flo VFD is turned **OFF**, and the motor lead is not connected to the Redi-Flo VFD.
2. Loosen and remove the Set Screw (position 12) from the Inlet Screen (position 1).
3. Slide the Inlet Screen off the pump. If you plan to use this motor lead again, be careful not to scrape insulation from it as the Inlet Screen is removed.
4. Loosen and remove the Pump Housing (position 2). Remove the impeller assembly (impellers, guide vanes, etc.).
5. Refer to the illustration on page 27. Use the special Motor Lead Screwdriver (shown at right) that came with your new motor lead to loosen and remove the Motor Lead Screw (position 14) for the ground lead (green/yellow wire).
6. Pull up on the ground lead to remove it. Using a small screwdriver and precision electronics pliers, pry up and remove the Teflon® Washer (position 15) and Brass Washers (position 16) from inside the enlarged Ground Motor Screw (position 13). Remove the Ground Motor Screw.
7. Use an allen wrench (2.5 mm) to remove the two Motor Screws (position 19) holding the Suction Interconnector (position 10) in place. Remove the Suction Interconnector but be very careful to note which of its slots is lined up with which motor lead -- this will be very helpful during reassembly. You may wish to scratch a mark on both the Suction Interconnector and the motor to aid in matching them up later.
8. Refer to the illustration at the bottom of this page. Use the special Motor Lead Screwdriver to loosen and remove the remaining Motor Lead Screws (position 14).
9. Pull up on each of the leads to remove them. Make a note which lead comes out of each hole -- **this is a MUST** when installing the new motor lead. Using a small screwdriver and precision electronics pliers, unscrew and remove the Teflon® Washer (position 15) and the Grommet (position 17).

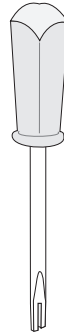

### INSTALLING THE NEW MOTOR LEAD

10. Ensure the motor lead holes are clean and free of moisture.
11. String the Inlet Screen (position 1) onto the motor lead.
12. String the motor lead components (shown at right) onto the end of each motor lead wire (except the striped green ground wire).
13. For each wire, place the Crimped Pin (position 18) down into the motor lead hole. Press the Grommet (position 17) and Teflon® Washer (position 15) down around the lead. Be sure to reconnect the lead wires in their previous pattern shown at left and described below.

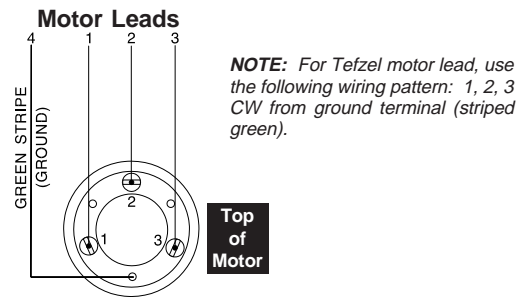

Page 21

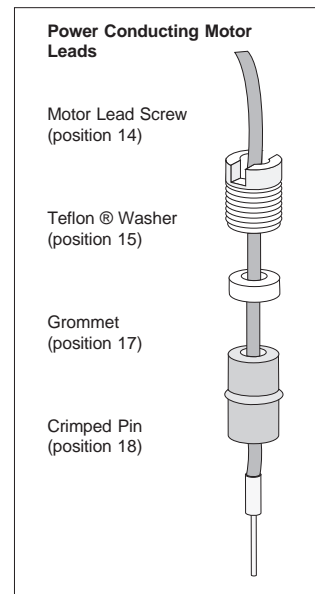

Teflon® is a registered trademark of DuPont

14. While pushing the lead down into the motor lead hole, use the special Motor Lead Screwdriver to tighten the Motor Lead Screw (position 14) into place. Repeat for the other two lead wires.
15. Replace the Suction Interconnector (position 10). Replace the Ground Motor Screw (position 13). Since the ground wire will be attached to this screw, you will want to put it into the hole that will cause the least amount of twisting to the wire.
16. Replace and tighten the two Motor Screws (position 19) with an allen wrench.
17. Repeat steps 12-14 for the ground motor lead. Note on the illustration (at right) that the ground lead uses two Brass Washers (position 16) instead of a Grommet and Crimped Pin.
18. Return the impeller assembly to the top of the Suction Interconnector (position 10). Refer to the diagram on page 25 for the proper sequence.
19. Screw the Pump Housing (position 2) back onto the Suction Interconnector.
20. Position the motor lead in the recessed area of the Pump Housing.
21. Carefully push the Inlet Screen (position 1) over the Pump Housing and the Suction Interconnector.

**BE VERY CAREFUL TO AVOID SCRAPING THE INSULATION FROM THE MOTOR LEAD AS THE INLET SCREEN IS FITTED.**

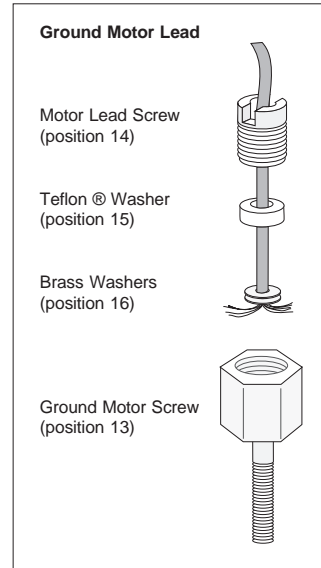

22. Line up the screw hole in the Inlet Screen with the screw hole in the Pump Housing. Fit and tighten the Set Screw (position 12).
23. Connect the motor lead to the Redi-Flo VFD and test the rotation of the pump. Submerge the pump in water, start it at its slowest speed and make sure the pump shaft is turning counterclockwise (when viewed from the top). If the rotation is incorrect, switching any two power leads (with POWER OFF) will correct the problem.
24. Reconnect the tubing or pipe.



## Periodic Motor Inspection

If the pump is operating at a decreased capacity and the impeller assembly components (impellers, guide vanes, etc.) do not appear to be the cause, the motor should be checked. A checklist of things to examine includes:

- Check the fluid level inside the motor (refer to page 20). Replace and refill as necessary.
- Inspect the outside of the motor for cracks, dents, etc.
- Remove the Inlet Screen (position 1), Pump Housing (position 2), and the impeller assembly (guide vanes, wear rings, etc.). Try to spin the motor shaft by hand. It should spin freely. If it does not, the motor must be replaced.
- Check the winding and insulation resistance of the motor and lead as described on page 23.

Teflon® is a registered trademark of DuPont

Page 22

## MAINTENANCE — REDI-FLO2®

### Winding Resistance

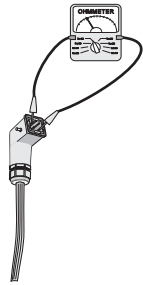

Turn the power off and disconnect the motor lead from the converter. Using an ohmmeter, set the scale to R X 1. Zero-adjust the meter and measure the resistance between any two power conducting leads (prongs on the motor lead plug).

If the ohm value is too low, the motor may be shorted. If too high, the motor windings or the leads may be open.

Lead Length	Ohm Value
0 ft	3.0 - 3.5 Ω
50 ft	3.6 - 4.1 Ω
75 ft	3.9 - 4.4 Ω
100 ft	4.2 - 4.7 Ω
125 ft	4.5 - 5.0 Ω
150 ft	4.8 - 5.3 Ω
175 ft	5.1 - 5.6 Ω
200 ft	5.4 - 5.9 Ω
250 ft	6.0 - 6.5 Ω
300 ft	6.6 - 7.1 Ω

### Insulation Resistance

Turn the power off and disconnect the motor lead from the converter. Use a 500V megohmmeter or megger (1 Meg = 1 M = 1 million). Zero-adjust the meter and measure the resistance between any power conducting leads (prongs on the motor lead plug) and ground. If the pump has been removed from the well, a good way to test this (as shown at right) is to submerge the motor lead and Redi-Flo2® pump in a bucket of water. Touch one lead of the megohmmeter to the pump and one to a motor lead.

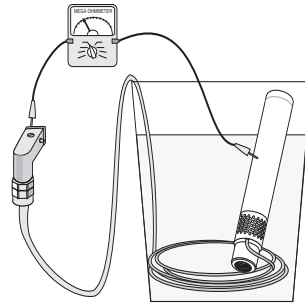

If the ohm value is lower than 1.5M Ω on any lead other than ground, the motor or lead is defective and must be replaced.

## Checking Components For Wear

The pump components should be periodically checked to ensure they are still within their minimum operating tolerances (illustrated below).

- Impeller** (position 5) ..... The impellers should show no visible wear.
- Guide Vane** (position 3) ..... The guide vanes should show no visible wear.
- Wear Ring** (position 4) ..... The minimum thickness ("A" in the illustration) should never be less than 1.0 mm.

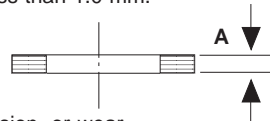

In addition, visually check all components for cracks, corrosion, or wear.

## Storage Requirements

The pump should be thoroughly cleaned before storage to ensure no contamination is present. Both the pump and the converter should be stored in a clean and dry area in the following temperature range:

1°C to +50°C  
or  
34°F to 120°F

## MAINTENANCE — REDI-FLO4™ VARIABLE PERFORMANCE PUMPS

### Pump & Motor Inspection

There is no periodic maintenance required for Redi-Flo4™ products. Should a problem develop, the following inspections should be performed:

If the pump is operating at a decreased capacity and the pump end does not appear to be the cause, the motor should be checked. Remove the pump end from the motor first by loosening and removing the four 1/2" nuts and pulling the pump end off the motor. Examine by following the checklist below:

1. Check motor and pump shaft rotation: spin the shaft by hand, it may be tight at first but should turn smoothly once started. If pump or motor does not turn freely, replace as necessary.
2. Check the fluid level inside the motor as described below. Replace and refill as necessary.
  - a. Turn the motor upside-down and remove the fill screw located in the center on the bottom.
  - b. Water should be visible through fill hole, refill by injecting deionized water as needed.
  - c. Rotate shaft to work out air pockets.
  - d. Tighten screw firmly taking care not to strip the screw threads.
3. Inspect the outside of motor and lead for cracks, dents, bulges, burns, etc.
4. Check the winding and insulation resistance of the motor and lead as described below:

### Winding Resistance

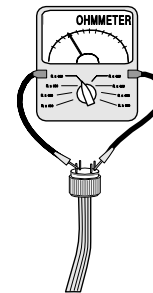

Turn the power off and disconnect the motor lead from the Redi-Flo VFD. Using an ohmmeter, set the scale to R X 1. Zero-adjust the meter and measure the resistance between any two power conducting leads (prongs in the motor lead plug).

If the ohm value is too low, the motor may be shorted. If too high, the motor windings or the leads may be open.

Lead Length	Ohm Value
0 ft	2.75 - 3.35 Ω
50 ft	2.90 - 3.50 Ω
100 ft	3.05 - 3.65 Ω
150 ft	3.20 - 3.80 Ω
200 ft	3.35 - 3.95 Ω
250 ft	3.50 - 4.10 Ω
300 ft	3.65 - 4.25 Ω
350 ft	3.80 - 4.40 Ω
400 ft	3.95 - 4.55 Ω
450 ft	4.10 - 4.70 Ω
500 ft	4.25 - 4.85 Ω
550 ft	4.40 - 5.00 Ω
600 ft	4.60 - 5.20 Ω

### Insulation Resistance

Turn the power off and disconnect the motor lead from the Redi-Flo VFD. Use a 500V megohmmeter or megger (1 Meg = 1 M = 1 million). Zero-adjust the meter and measure the resistance between any power conducting lead (prongs in the motor lead plug) and ground. If the pump has been removed from the well, a good way to test this (as shown at right) is to submerge the motor lead and pump in water. Touch one lead of the megohmmeter to the pump and one to a motor lead.

If the ohm value is lower than 1.5M Ω on any lead other than ground, the motor or lead is defective and must be replaced.

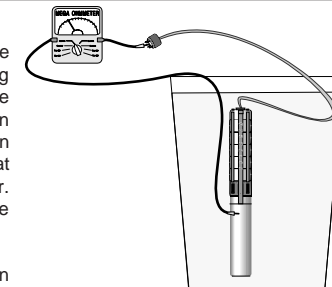



## MAINTENANCE — REDI-FLO4™ VARIABLE PERFORMANCE PUMPS

### Replacing the Motor Lead / Motor

#### Removing the Old Motor Lead

1. Make sure the motor lead is not connected to the Redi-Flo VFD. Remove the cable guard from the pump end. Remove the pump end from the motor by loosening and removing the four ½" nuts from the motor studs and pulling the pump end off the motor.
2. Remove the two motor lead plug screws from the top of the motor and pull the motor lead plug from the motor by rocking the plug side to side while pulling.

#### Installing the New Motor Lead

1. Make sure the motor lead socket in the motor is clean and free of debris and moisture.
2. Remove the baggie from the new motor lead plug and firmly slide it into position in the motor lead socket.
3. Tighten the motor lead plug screws evenly from side to side until firmly bottomed with the motor lead plug, flush with the top of the motor as shown below. A 0mm to 1mm gap between the center of the motor lead plug and the top of the motor is acceptable as shown.

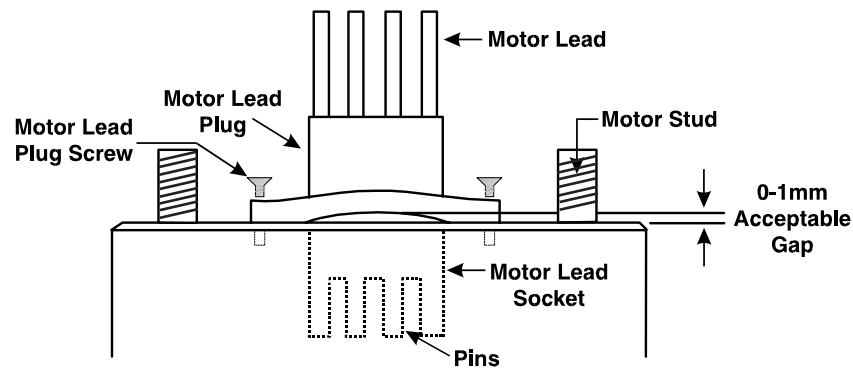

## MAINTENANCE — REDI-FLO4™ VARIABLE SPEED PUMPS

#### Reattaching Pump End to Motor

1. Fit the pump end to the motor making sure the motor lead aligns with the recess in the pump inlet and the motor studs align with the holes in the bottom of the pump inlet.
2. The pump should drop right into place flush with the top of the motor. If it does not, lift the pump end back up and slightly rotate the motor shaft, as the shaft is most likely not aligned with the pump end shaft coupling and stopping the pump from dropping into position. In addition gently rocking the pump back and forth may aid in getting it to drop into position also.
3. Put the four ½" nuts in place and tighten them diagonally to assure even pressure. The nuts should be torqued to 13 ft. lbs.
4. Reattach the cable guard to the pump end.

The pump is now ready for operation.

# ASSEMBLY DIAGRAM — REDI-FLO2®

## Pump Components

Pos. No.	Part Description	No. Used Per Pump	Part Number
1	Inlet Screen	1	1A0004
2	Pump Housing 1/2" NPT	1	1A0044
3	Guide Vane	2	see Service Kits
4	Wear Ring	2	"
5	Impeller	2	"
6	Spacer Ring	2	"
7	Wear Plate	2	"
8	Motor Lead Assembly	4	see Pos. 13 - 18
9	Shaft	1	not available *
10	Suction Interconnector	1	1A5004
11	Stator Housing	1	not available *
12	Set Screw	1	see Service Kits
13	Ground Motor Screw	1	"
14	Motor Lead Screw	4	"
15	Teflon® Washer	4	"
16	Brass Washer	2	"
17	Grommet	3	"
18	Crimped Pin	3	"
19	Motor Screw (long)	2	"
20	Motor Screw (short)	6	"
21	Filling Screw w/ O-Ring	1	"
22	Motor Thrust Washers	2	"
23	Lip Seal	1	ID5566
24	Bearing Housing O-Ring	2	see Service Kits

Teflon® is a registered trademark of Du Pont

\*Not economical to replace. Must purchase complete pump/motor

### MOTOR LEAD ASSEMBLY (position 8)

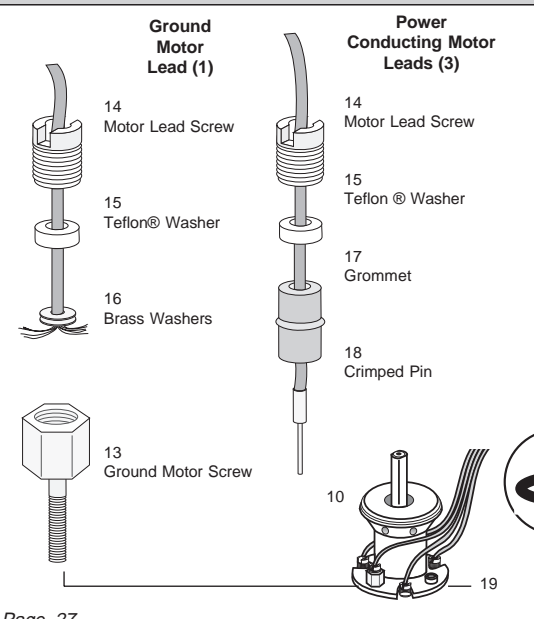

Page 27

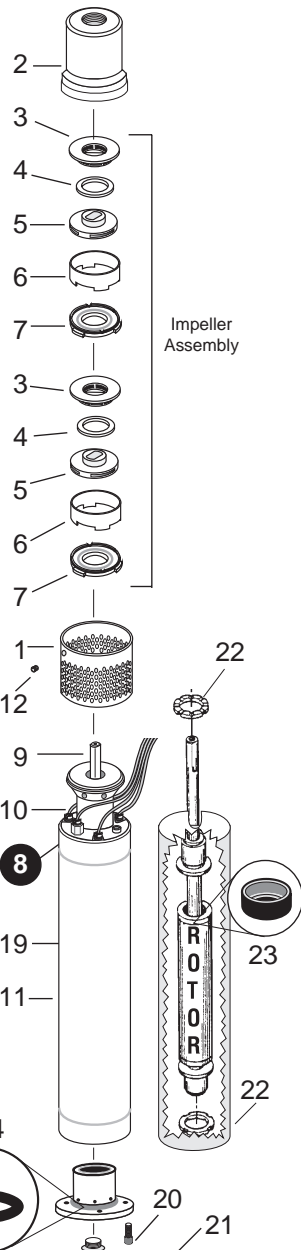

# REDI-FLO2® PARTS LIST

## Redi-Flo2® Service Kits, Tools, and Motor Leads

Replacement parts, service tools, and motor leads are available using the following part numbers:

Service Kits			Part Number	
Position No. In Diagram	Part Description	No. In Kit		
3	Guide Vane .....	2	125061	
4	Wear Ring .....	2		
5	Impeller .....	2		
6	Spacer Ring .....	2		
7	Wear Plate .....	2		
4	Wear Ring .....	4		1A5050
7	Wear Plate .....	4		
13	Ground Motor Screw .....	1	1A00028	
14	Motor Lead Screw .....	4		
15	Teflon® Washer .....	4		
16	Brass Washer .....	2		
17	Grommet .....	3		
18	Crimped Pin .....	3		
5	Impeller .....	2	1A00018	
12	Set Screws .....	25		
14	Motor Lead Screws .....	12		
15	Teflon® Washer .....	25		
16	Brass Washer .....	25		
17	Grommet .....	25		
18	Crimped Pin .....	50		
19	Motor Screw (long) .....	25		
20	Motor Screw (short) .....	25		
21	Filling Screw with O-Ring .....	5		
22	Motor Thrust Washers .....	4	1A00128	
24	Bearing Housing O-Ring .....	10		

Teflon® is a registered trademark of DuPont

Service Tools		Part Number
Special Motor Lead Screwdriver		SV0370
Syringe (to refill motor)		ID6066
Crimping Tool Kit (Required to crimp, "crimped pin").		1A00141
All motor leads come with a VFD Plug attached and a special Motor Lead Screwdriver		
	30 foot length	1A 5100
	50 " "	1A 5101
	75 " "	1A 5102
	100 " "	1A 5103
	125 " "	1A 5104
	150 " "	1A 5105
	175 " "	1A 5106
	200 " "	1A 5107
	250 " "	1A 5108
	300 " "	1A 5109

Page 28



## PARTS/ACCESSORY LIST

### Redi-Flo VFD

DESCRIPTION	PART NUMBER
SI/MP1, 115/230V, VFD, Complete	96022675
115V Power Cord	ID8618
MOV Replacement Pack	1A032Z

### Redi-Flo4™ Variable Performance Replacement Pump Ends & Motor

DESCRIPTION	PART NUMBER
5E8 PE	08030008
10E5 PE	09030005
16E4 PE	10030004
25E3 PE	05030003
2 HP - 3 PH - 230V MS402E	96022532

### Redi-Flo VFD x RF4 Variable Performance Pump Accessories

DESCRIPTION	PART NUMBER
Splice Kit for RF4 VFD Receptacle	96022677
RF4 x VFD Adapter Cord, 6 Ft.*	96022657
RF4 x VFD Adapter Cord, 12 Ft.*	96022658
RF4 x VFD Adapter Cord, 20 Ft.*	96022659

\* You must have one adapter cord to operate Redi-Flo4™ variable speed pumps.

## ACCESSORY LIST

### General Redi-Flo2® & 4 Accessories

DESCRIPTION	PART NUMBER
<b>Redi-Flo2® (MP1) Well Seal</b>	
2" SCH 5-20 Well Seal	1A016Z
2" SCH 40-80 Well Seal	1A5111
4" SCH 5-20 Well Seal	1A017Z
4" SCH 40-80 Well Seal	1A5110
<b>Redi-Flo2® Safety Cable Bracket</b>	
(Placed between the top of the pump and discharge piping connector)	1A0019
<b>Redi-Flo2® Cooling Shroud</b>	1A004Z
<b>Redi-Flo2® Stainless Steel Ball Check Valve</b>	
½" Male NPT x ½" Female NPT	1A009Z

\*For use with ½" ID or greater tubing or pipe.



**NOTES**

**NOTES**





**NOTES**

**NOTES**

