



# 2020<sup>e/i</sup> Turbidity Meter



2020e • Code 1979-EPA

2020i • Code 1979-ISO

Version 1.5 • Code 1979-MN • 5-12-06



WARNING! This set contains chemicals that may be harmful if misused. Read cautions on individual containers carefully. Not to be used by children except under adult supervision

---

# CONTENTS

---

## General Information

Packaging and Delivery . . . . .	5
General Precautions . . . . .	5
Safety Precautions . . . . .	5
Limits of Liability . . . . .	5
Specifications . . . . .	6-7
Statistical and Technical Definitions Related to Product Specifications . . . . .	8
Contents and Accessories . . . . .	9
EPA Compliance . . . . .	10
ISO Compliance . . . . .	10
CE Compliance . . . . .	10
Warranty . . . . .	10

---

## General Operating Information

Overview . . . . .	11-12
The Keypad . . . . .	13
The Display & Menus . . . . .	14-17
Tubes . . . . .	18

---

## Introduction

Turbidity	
What is Turbidity?. . . . .	19
How is Turbidity Measured? . . . . .	20-21
Taking Turbidity Water Samples . . . . .	21
Sample Dilution Techniques . . . . .	21

---

## Options and Set Up

Turbidity	
Selecting Turbidity Units . . . . .	22-23
Selecting a Turbidity Calibration Curve . . . . .	23-24
Averaging . . . . .	25-26
Setting Date & Time . . . . .	26-27
Selecting a Language . . . . .	28
Setting Auto Shutdown . . . . .	29

---

Data Logging . . . . .	30-31
------------------------	-------

---

Tube Positioning Ring . . . . .	32
---------------------------------	----

---

*continued next page...*

---

## Calibration and Analysis

### Turbidity

Analysis . . . . .	32-35
Dilution Procedures . . . . .	36
Preparation of Turbidity-Free Water . . . . .	36-37
Turbidity Standards . . . . .	38
Calibration Procedure . . . . .	38-42
Testing Tips . . . . .	42-43

---

<b>Troubleshooting Guide</b> . . . . .	44
--	----

---

<b>PC Link</b> . . . . .	45
--------------------------	----

Output . . . . .	45
Computer Connection . . . . .	45

---

## Battery Operation

Replacing the Battery . . . . .	45
---------------------------------	----

---

## Maintenance

Cleaning. . . . .	46
Repairs . . . . .	46
Meter Disposal . . . . .	46

---

## GENERAL INFORMATION

### Packaging and Delivery

---

Experienced packaging personnel at LaMotte Company assure adequate protection against normal hazards encountered in transportation of shipments.

After the product leaves LaMotte Company, all responsibility for safe delivery is assured by the transportation company. Damage claims must be filed immediately with the transportation company to receive compensation for damaged goods.

### General Precautions

---

**READ THE INSTRUCTION MANUAL BEFORE ATTEMPTING TO SET UP OR OPERATE THE METER.** Failure to do so could result in personal injury or damage to the meter. The meter should not be used or stored in a wet or corrosive environment. Care should be taken to prevent water from wet tubes from entering the meter chamber.

NEVER PUT WET TUBES IN THE METER.

### Safety Precautions

---

Read the label on all reagent containers. Some labels include precautionary notices and first aid information. Certain reagents are considered potential health hazards and are designated with a \* in the instruction manual. To view or print a Material Safety Data Sheet (MSDS) for these reagents see MSDS CD or go to [www.lamotte.com](http://www.lamotte.com). To obtain a printed copy, contact LaMotte by e-mail, phone or FAX. Additional information for all LaMotte reagents is available in the United States, Canada, Puerto Rico, and the US Virgin Islands from Chem-Tel by calling 1-800-255-3924. For other areas, call 813-248-0585 collect to contact Chem-Tel's International access number. Each reagent can be identified by the four-digit number listed on the upper left corner of the reagent label, in the content list and in the test procedures.

### Limits of Liability

---

Under no circumstances shall LaMotte Company be liable for loss of life, property, profits, or other damages incurred through the use or misuse of their products.

## Specifications - 2020e and 2020i

---

Instrument Type:	Nephelometer
Standard:	EPA 180.1, 2020e ISO7027, 2020i
Units of Measure:	NTU (Nephelometric Turbidity Units) FNU (Formazin Nephelometric Units) ASBC (American Society of Brewing Chemists) EBC (European Brewery Convention) FAU (Formazin Attenuation Unit)
Range:	0-4000 NTU, 0-4000 FNU, 40-4000 FAU, 0-35000 ASBC, 0-500 EBC
Range Selection:	Automatic, 2020e, Automatic, 2020i
Resolution: (display)	0.01 NTU, 0–10.99 NTU Range 0.1 NTU, 11–109.99 NTU Range 1 NTU, 110–4000 NTU Range
Accuracy:	±0.05 or ±2% of reading, whichever is greater, below 100 NTU ±3% of reading, above 100 NTU
Detection Limit:	0.05 NTU
Light Source:	Tungsten lamp 2300°C ±50 °C, 2020e; IR LED 860 nm ±10 nm, spectral bandwidth 50 nm, 2020i
Detector:	Photodiode, centered at 90°, maximum peak 550 nm, 2020e; Photodiode, centered at 90°, 2020i
Light Source Stabilization:	Automatic
Response Time:	<5 seconds
Signal Averaging:	Yes
Sample Chamber:	Accepts 25 mm flat-bottomed test tubes
Sample:	10 mL in capped tube
Display:	Graphic Liquid Crystal Display
Software:	Data Logging: 4004 points Auto Shut-off: 5, 10, 30 min, disabled Calibration: Field adjustable, 2-points
Languages:	English, French, Spanish, Japanese (Kana), Portuguese, Italian
Temperature:	Operation: 0–50 °C; Storage: -40–60 °C
Operation Humidity Range:	0–90 % RH, non-condensing
Auto Shutdown:	0, 5, 10 or 30 minutes

---

Power Source\*:      Battery Operation: 9 volt alkaline  
                             Line Operation: Input: 100-240VAC/50-60Hz with imbedded  
                             IEC socket (2 pin)  
                             Output: 9VDC REG 1.2A with 2.1 x 5.5 mm output plug center  
                             positive

---

Battery Life:            >250 tests, 2020e  
                             >2500 tests, 2020i  
                             (with signal averaging disabled)

---

Dimensions  
(L x W x H):            8.5 x 16.2 x 6.7 cm; 3.4 x 6.4 x 2.6 inches

---

Weight:                    339 g, 12 oz (meter only)

---

Serial Interface:        RS232, 8 pin mDIN, 9600b, 8, 1, n

---

\*CE Mark: The device complies to the product specifications for the Low Voltage Directive when furnished with the 100-240V AC Adapter (Code 1754).

## Statistical and Technical Definitions Related to Product Specifications

**Method Detection Limit (MDL):** "The method detection limit (MDL) is defined as the minimum concentration of a substance that can be measured and reported with 99% confidence that the analyte concentration is greater than zero and is determined from analysis of a sample in a given matrix containing the analyte."<sup>1</sup> Note that, "As Dr. William Horwitz once stated, 'In almost all cases when dealing with a limit of detection or limit of determination, the primary purpose of determining that limit is to stay away from it.'"<sup>2</sup>

**Accuracy:** Accuracy is the nearness of a measurement to the accepted or true value.<sup>3</sup> The accuracy can be expressed as a range, about the true value, in which a measurement occurs (i.e.  $\pm 0.5$  ppm). It can also be expressed as the % recovery of a known amount of analyte in a determination of the analyte (i.e. 103.5 %).

**Resolution:** Resolution is the smallest discernible difference between any two measurements that can be made.<sup>4</sup> For meters this is usually how many decimal places are displayed. (i.e. 0.01). Note that the resolution may change with concentration or range. In some cases the resolution may be less than the smallest interval, if it is possible to make a reading that falls between calibration marks. *A word of caution, that resolution has very little relationship to accuracy or precision. The resolution will always be less than the accuracy or precision but it is not a statistical measure of how well a method of analysis works. The resolution can be very, very good and the accuracy and precision can be very bad! This is not a useful measure of the performance of a test method.*

**Repeatability:** Repeatability is the within-run precision.<sup>5</sup> A run is a single data set, from set up to clean up. Generally, one run occurs on one day. However, for meter calibrations, a single calibration is considered a single run or data set, even though it may take 2 or 3 days.

**Reproducibility:** Reproducibility is the between-run precision.<sup>6</sup>

**Detection Limit (DL):** The detection limit (DL) for the 2020 is defined as the minimum value or concentration that can be determined by the meter, which is greater than zero, independent of matrix, glassware, and other sample handling sources of error. It is the detection limit for the optical system of the meter.

<sup>1</sup> CFR 40, part 136, appendix B

<sup>2</sup> Statistics in Analytical Chemistry: Part 7 – A Review, D. Coleman and L Vanatta, American Laboratory, Sept 2003, P. 31.

<sup>3</sup> Skoog, D.A., West, D. M., *Fundamental of Analytical Chemistry*, 2<sup>nd</sup> ed., Holt Rinehart and Winston, Inc, 1969, p. 26.

<sup>4</sup> Statistics in Analytical Chemistry: Part 7 – A Review, D. Coleman and L Vanatta, American Laboratory, Sept 2003, P. 34.

<sup>5</sup> Jeffery G. H., Basset J., Mendham J., Denney R. C., *Vogel's Textbook of Quantitative Chemical Analysis*, 5<sup>th</sup> ed., Longman Scientific & Technical, 1989, p. 130.

<sup>6</sup> Jeffery G. H., Basset J., Mendham J., Denney R. C., *Vogel's Textbook of Quantitative Chemical Analysis*, 5<sup>th</sup> ed., Longman Scientific & Technical, 1989, p. 130



## Contents and Accessories

	2020e Kit EPA Version Code 1979-EPA	2020i Kit ISO Version Code 1979-ISO
<b>CONTENTS</b>	Code	Code
0 NTU Standard, 60 mL	1480	1480
1 NTU Standard, 60 mL	1484	1481
10 NTU Standard, 60 mL	1485	1482
Water Sample Bottle, 60 mL	0688	0688
Tubes, 4 (Two with tube positioning ring)	—	—
Battery, 9V	—	—

### ACCESSORIES

1486	100 NTU Standard, 60 mL (EPA)
1483	100 NTU Standard, 60 mL (ISO)
0475	Tubes, Code 0290, Set of 6
0641	Tube Positioning Ring, Pack of 2
4185	Turbidity-Free Water Kit
2-2097	Filters, 0.1 micron, Pack of 50
1772	Interface Cable, RS232
1754	AC Adapter, 9V (variable 100-240V)
1912-3 or 1912-CD	SMARTLink 2 Software and Interface Cable

## EPA Compliance

---

The 2020e meter meets or exceeds EPA design specifications for NPDWR and NPDES turbidity monitoring programs as specified by the USEPA method 180.1.



## ISO Compliance

---

This 2020i meter meets or exceeds ISO design criteria for quantitative methods of turbidity using optical turbidimeters as specified by ISO 7027.



## CE Compliance

---

The 2020e and 2020i meters have been independently tested and have earned the European CE Mark of compliance for electromagnetic compatibility and safety.



To view certificates of compliance, see our website [www.lamotte.com](http://www.lamotte.com)

NOTE: The device complies to the product specifications for the Low Voltage Directive when furnished with the AC Adapter (Code 1754).

## Warranty

---

The 2020e and 2020i meters are guaranteed to be free of defects in material and workmanship for two years from original purchase date. If within that time the meters are found to be defective, they will be repaired without charge except for transportation costs. The guarantee does not cover batteries.



# GENERAL OPERATING INFORMATION

## Overview

The 2020 is a portable, microprocessor controlled, direct reading nephelometer. Turbidity is measured directly by either EPA Method 180.1 or ISO Method 7027. It has a graphical liquid crystal display and 6 button keypad. These allow the user to select options from the menu driven software, to directly read test results, or to review stored results of previous tests in the data logger. The menus can be displayed in six different languages.

The 2020 uses a state of the art, multi-detector micro optical configuration that assures long term stability of calibrations, high precision and accuracy, and low detection limits. All readings are determined by sophisticated digital signal processing algorithms, minimizing fluctuations in readings and enabling rapid, repeatable measurements. The microprocessor and optics enable a dynamic range and auto-ranging over several ranges. Energy efficient LED light sources are used for ISO turbidity. EPA turbidity uses a tungsten filament light source that meets or exceeds EPA specifications and is designed for a uniform light spot image and stable output.

Tube positioning rings are supplied with the 2020. These rings snap onto the shoulders of the tubes. The rings ensure that the tubes are positioned in the chamber in the same orientation from one reading to the next. This minimizes variations in readings due to differences in tube position. This results in greater repeatability and is especially important for samples with low turbidity.

A 9-volt alkaline battery powers the 2020 and an optional AC adapter is available. A fresh battery should be installed at all times even when using the AC adapter.

An RS232 serial port on the back of the meter allows an interface of the meter with an IBM compatible computer for real-time data acquisition and data storage using a PC. The 2020 may be interfaced with any Windows-based computer by using the LaMotte SMARTLink 2 Program. The port also allows an interface with an RS232 serial printer.

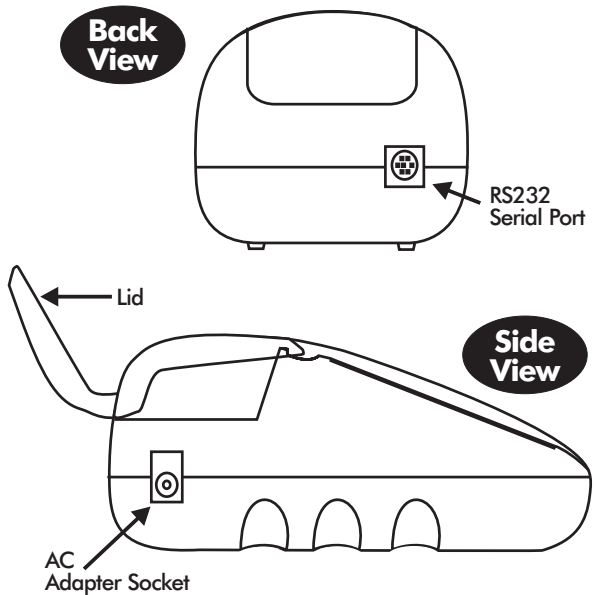

**Top View**

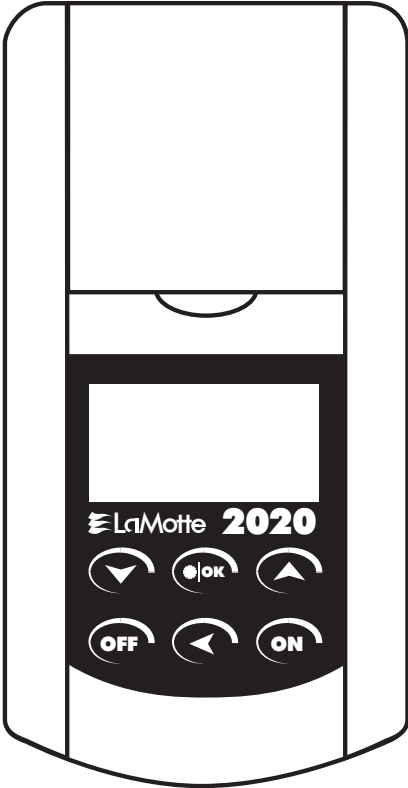

**Bottom View**

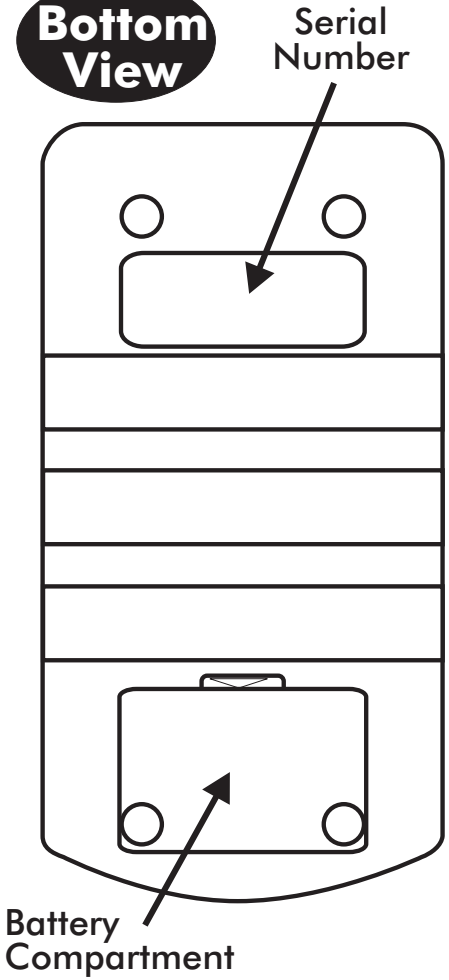

## General Operating Information

---

The operation of the 2020 is controlled by the menu driven software and user interface. A menu is a list of choices. This allows a selection of various tasks for the 2020 to perform, such as, scan blank and scan sample. The keypad is used to make menu selections that are viewed on the display.

## The Keypad

---

- ▼ This button will scroll down through a list of menu selections.

---

- \*|OK This button is used to select menu choices adjacent to the \* in a menu viewed in the display

---

- ▲ This button will scroll up through a list of menu selections.

---

- OFF This button turns the 2020 off.

---

- ◀ This button is an exit or escape button. When pressed, the display will exit the current menu and go to the previous menu.

---

- ON This button is used to turn on the 2020.

---



## The Display & Menus

The display allows menu selections to be viewed and selected. These selections instruct the 2020 to perform specific tasks. The menus are viewed in the display using two general formats that are followed from one menu to the next. Each menu is a list of choices or selections.

The display has a header line at the top and a footer line at the bottom. The header displays the title of the current menu. The footer line displays the time and the date. The menu selection window is in the middle of the display between the header and the footer.

The menu selection window displays information in two general formats. In the first format only menu selections are displayed. Up to 4 lines of menu selections may be displayed. If more selections are available they can be viewed by pressing the arrow buttons (▲ or ▼) to scroll the other menu selections into the menu selection window. Think of the menu selections as a vertical list in the display that moves up or down each time an arrow button (▲ or ▼) is pressed. All menus in the 2020 are looping menus. The top and bottom menu choices are connected in a loop. Scrolling down past the bottom of the menu will lead to the top of the menu. Scrolling up past the top of the menu will lead to the bottom of the menu.

Header	<b>Menu Title</b>
Menu Selection Window	<b>* First Choice</b> <b>Second Choice</b> <b>Another</b> <b>and another</b>
Footer	<b>16:02:19</b> <b>01/04/05</b> <b>and another</b> <b>and so on</b>

An asterisk, \*, will start in the far left position of the top line in the menu choice window. To move the \* press the up or down arrow buttons (▲ or ▼) to scroll through the menu selections. The \* in the display corresponds with the \***IOK** button. Pushing the \***IOK** button selects the menu choice which is adjacent to the \* in the menu selection window.

In the second format the menu choice window takes advantage of the graphical capabilities of the display. Large format graphic information, such as test results or error messages or the LaMotte logo is displayed. The top three lines of the display are used to display information in a large, easy to read format. The menus work in the same way as previously described but only one line of the menu is visible at the bottom of the display. On the lower right side of the display small up and down arrows (▲ or ▼) indicate that other menu selections are available above or below the one visible line of the menu.

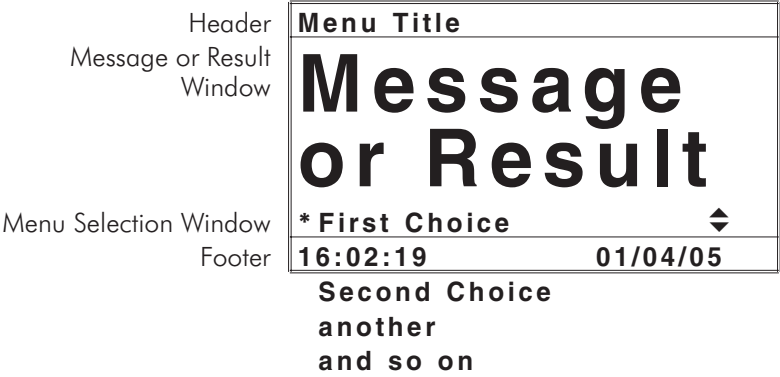

As described previously, the ◀ button allows an exit or escape from the current menu and a return to the previous menu. This allows a rapid exit from an inner menu to the main menu by repeatedly pushing the ◀ button. Pushing **OFF** at any time will turn the 2020 off.

The display may show the following messages:

<b>Err1</b>	Low battery.
<b>Err2</b>	An attempt was made to calibrate the meter outside of the allowable range.
<b>Err3</b>	An attempt was made to calibrate the meter with a zero sample.
<b>Err4</b>	Processing error.
<b>Err5</b>	No blank reading – the meter has never been blanked for this test factor.
<b>Err6</b>	The meter must be re-blanked and the sample rescanned.
<b>Err7</b>	Call LaMotte Tech Service – meter may have to be returned for repairs.
<b>low battery</b>	Low battery
>	Over range indicator.
▲▼	More choices are available and can be viewed by scrolling up and/or down through the display.
Header	Identifies the current menu and information on units and reagent systems if applicable. In the data logging mode the number of the data point is displayed and the total number of data points in the memory will be shown.

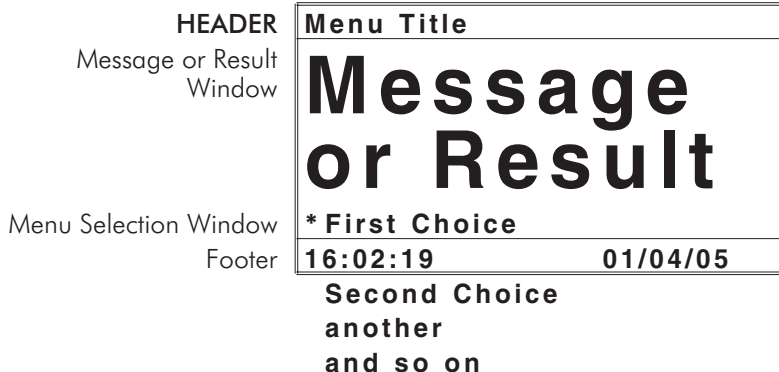



Footer	Shows current time and date.
--------	------------------------------

Header  
Message or Result  
Window

<b>Menu Title</b>
<b>Message or Result</b>
<b>* First Choice</b>
<b>16:02:1901/04/05</b>

Menu Selection Window  
**FOOTER**

**Second Choice**  
**another**  
**and so on**

### Negative Results

There are always small variations in readings with analytical instruments. Often these variations can be observed by taking multiple readings of the same sample. These variations will fall above and below an average reading. Repeated readings on a 0.00 sample might give readings above and below 0.00. Therefore, negative readings are possible and expected on samples with concentrations at or near zero. This does not mean there is a negative concentration in the sample. It means the sample reading was less than the blank reading. Small negative readings can indicate that the sample was at or near the detection limit. This is a normal variation that results in a negative reading. A large negative reading, however, is not normal and indicates a problem. Some instruments are designed to display negative readings as zero. In this type of instrument, if the meter displayed zero when the result was actually a large negative number there would be no indication that a problem existed. For this reason, the 2020 displays negative numbers.

### Tubes

The 2020 uses one type of tube (Code 0290) for the turbidity test. There is no need for a special turbidity tube.

The handling of the tubes is of utmost importance. Tubes must be clean and free from lint, fingerprints, dried spills and significant scratches, especially the central zone between the bottom and the sample line.

Scratches, fingerprints and water droplets on the tube can cause stray light interference leading to inaccurate results when measuring turbidity. Scratches and abrasions will affect the accuracy of the readings. Tubes that have been scratched in the light zone through excessive use should be discarded and replaced with new ones.

Tubes should always be washed on the inside and outside with mild detergent prior to use to remove dirt or fingerprints. The tubes should be allowed to air-dry in an inverted position to prevent dust from entering the tubes. To prevent introducing moisture into the meter chamber, tube positioning rings should be removed before washing tubes. If tubes are washed with tube positioning rings in place, the rings should be removed and thoroughly dried before replacing them on the dry tubes. Dry tubes should be stored with the caps on to prevent contamination.

After a tube has been filled and capped, it should be held by the cap and the outside surface should be wiped with a clean, lint-free absorbent cloth until it is dry and smudge-free. Handling the tube only by the cap will avoid problems from fingerprints. Always set the clean tube aside on a clean surface that will not contaminate the tube. It is imperative that the tubes and light chamber be clean and dry. The outside of the tubes should be dried with a clean, lint-free cloth or disposable wipe before they are placed in the meter chamber.

Tubes should be emptied and cleaned as soon as possible after reading a sample to prevent deposition of particulates on the inside of the tubes. When highly accurate results are required, reduce error by designating tubes to be used only for very low turbidity and very high turbidity testing.

Variability in the geometry of the glassware and technique are the predominate causes of variability in results. Slight variations in wall thickness and the diameter of the tubes may lead to slight variations in the test results. To eliminate this error the tubes should be placed in the chamber with the same orientation each time. The orientation of the tubes in the chamber is controlled by use of a tube positioning ring. For improved accuracy and precision, especially at low concentrations, the tubes should always be used with a positioning ring. (See page 32)

---

## INTRODUCTION

### TURBIDITY

---

#### What is Turbidity?

---

Turbidity is an aggregate property of the solution, water in most cases. Turbidity is not specific to the types of particles in the water. They could be suspended or colloidal matter and they can be inorganic, organic or biological. At high concentrations turbidity is perceived as cloudiness or haze or an absence of clarity in the water. Turbidity is an optical property that results when light passing through a liquid sample is scattered. The scattering of light results in a change in the direction of the light passing through the liquid. This is most often caused when the light strikes particles in solution and is scattered backward, sideways and forward. If the turbidity is low much of the light will continue in the original direction. Light scattered by the particles allows the particle to be "seen" or detected in solution. Just as sunlight passing through a window is scattered by dust particles in the air, allowing them to be seen.

In the past 10 years, turbidity has become more than just a measure of water clarity. Because of the emergence of pathogens such as *Cryptosporidium* and *Giardia*, turbidity now holds the key to assuring proper water filtration. In 1998, the EPA published the IESWTR (interim enhanced surface water treatment rule) mandating turbidities in combined filter effluent to read at or below 0.3 NTU. By doing so, the EPA hoped to achieve a 2 log (99%) removal of *Cryptosporidium*. There is presently consideration to lower this to 0.1 NTU. The trend has been to check the calibration of on-line turbidimeters with hand-held field units. The optical design and low detection limit of the 2020 allow very accurate readings for such calibrations.

The meter also allows the user to choose the units of measure for expressing turbidity. While nephelometric turbidity unit (NTU) has been the standard for years, FNU (formazin nephelometric unit) and FAU (formazin attenuation unit) are now being used in ISO 7027 units. American Society of Brewing Chemists (ASBC) units and European Brewery Convention (EBC) units allow the brewing industry to check process waters.

## How is Turbidity Measured?

---

Turbidity is measured by detecting and quantifying the scattering of light in water (solution). Turbidity can be measured in many ways. There are visual methods and instrumental methods. Visual methods are more suitable for samples with high turbidity. Instrumental methods can be used on samples with both high and low levels of turbidity.

Two visual methods are the Secchi Disk method and the Jackson Candle method. The Secchi Disk method is often used in natural waters. A black and white Secchi Disk is lowered into the water until it can no longer be seen. It is then raised until it can be seen again. The average of these two distances is known as the “Secchi Depth”. The Jackson Candle method uses a long glass tube over a standard candle. Water is added or removed from the tube until the candle flame becomes indistinct. The depth of the water measured with a calibrated scale is reported as Jackson Turbidity Units (JTU). The lowest turbidity that can be determined with this method is about 25 NTU.

There are two common methods for instruments to measure turbidity. Instruments can measure the attenuation of a light beam passing through a sample and they can measure the scattered light from a light beam passing through a sample. In the attenuation method, the intensity of a light beam passing through turbid sample is compared with the intensity passing through a turbidity-free sample at 180° from the light source. This method is good for highly turbid samples. The most common instrument for measuring scatter light in a water sample is a nephelometer. A nephelometer measures light scattered at 90° to the light beam. Light scattered at other angles may also be measured, but the 90° angle defines a nephelometric measurement. The light source for nephelometric measurements can be one of two types to meet EPA or ISO specifications. The EPA specifies a tungsten lamp with a color temperature of 2,200–3,000 K. The units of measurement for the EPA method are nephelometric turbidity units (NTU). The ISO specifies a light emitting diode (LED) with a wavelength of 860 nm and a spectral bandwidth less than or equal to 60 nm. The units of measurement for the ISO method are formazin nephelometric units (FNU). The 2020e meets the EPA specification and the 2020i meets the ISO specification. The nephelometric method is most useful for low turbidity.

The 2020 is a nephelometer that is capable of measuring turbidity by both the attenuation method and the nephelometric method. It uses a detector placed at 180° to the light source for the attenuation method. It uses a detector placed at 90° to the light source for the Nephelometric method. The 2020 also has a third detector that monitors the intensity of the light source. It uses this detector to improve instrumental stability and minimize calibration drift. The 2020 also has a signal averaging option to improve the stability of readings on low turbidity samples.

The 2020 has two different turbidity calibrations, formazin and Japan Standard. The formazin calibration is the EPA and ISO approved method of calibrating nephelometers. This calibration can be used with user prepared formazin standards or commercially purchased formazin standards. LaMotte Company approved AMCO™ standards labeled for use with the 2020 can also be used with the formazin calibration. Stabcal® standards below 50 NTU should not be used to calibrate the 2020.

The Japan Standard calibration is a calibration for a Japanese Water Works standard. It is based on Japanese formulated polystyrene turbidity standards. This calibration should only be used to meet Japanese Water Works requirements. The Japanese polystyrene standards can only be purchased in Japan. Formazin, AMCO and Stablcal® standards cannot be used with this calibration.

### Taking Turbidity Water Samples

Clean plastic or glass containers may be used for turbidity samples. Ideally, samples should be tested soon after collection and at the same temperature as when collected.

### SAMPLE DILUTION TECHNIQUES

If a test result is out of the range of the meter, it must be diluted. The test should then be repeated on the diluted sample. The following table gives quick reference guidelines for dilutions of various proportions.

Amount of Sample	Deionized Water to Bring Final Volume to 10 mL	Multiplication Factor
10 mL	0 mL	1
5 mL	5 mL	2
2.5 mL	7.5 mL	4
1 mL	9 mL	10
0.5 mL	9.5 mL	20

All dilutions are based on a final volume of 10 mL so several dilutions will require small volumes of the water sample. Graduated pipets should be used for all dilutions. If volumetric glassware is not available, dilutions can be made with the colorimeter tube. Fill the tube to the 10 mL line with the sample and then transfer it to another container. Add 10 mL volumes of deionized water to the container and mix. Transfer 10 mL of the diluted sample to the colorimeter tube and follow the test procedure. Repeat the dilution and testing procedures until the result falls within the range of the calibration. Multiply the test result by the dilution factor. For example, if 10 mL of the sample water is diluted with three 10 mL volumes of deionized water, the dilution factor is four. The test result of the diluted sample should be multiplied by four.

## OPTIONS & SET UP

Settings that have user options have been set at the factory to default settings.

*The factory default settings are:*

Turbidity Units	NTU
Turbidity Calibration	formazin
Averaging	Disabled
Date Format	MM/DD/YY
Language	English
Auto Shutdown	Disabled

To return the meter to the factory settings, Hold down **\*IOK** button. Press **ON**. Release both buttons. Press **\*IOK** button to select the default settings. Meter will turn off and the factory settings will be restored. Restoring the factory settings will remove the user-level calibration but not the zeroing. To change the default settings follow the instructions in the following sections.

## TURBIDITY

The default units are NTU and the default calibration curve is formazin. To change the settings:

### SELECTING TURBIDITY UNITS

1. Press **ON** to turn the meter on.



2. Scroll down and then press **\*IOK** to select **Options**.

<b>Main Menu</b>	
Measure	
Data Logging	
* Options	
16:02:19	01/04/05

3. Scroll down and then press **\*IOK** to select **Turbidity**.

<b>Options</b>	
Averaging	
* Turbidity	
Date/Time	
Language	
16:02:19	01/04/05

4. Press the <b>*IOK</b> to select <b>Units</b> .	<b>Turbidity</b>	
	<b>* Units Calibration</b>	
	<b>16:02:19</b>	<b>01/04/05</b>

5. Scroll down and then press <b>*IOK</b> to select units.  Available units are: <b>NTU</b> (Nephelometric Turbidity Units); <b>FNU</b> (Formazin Nephelometric Units); <b>ASBC</b> (American Society of Brewing Chemists); <b>EBC</b> (European Brewery Convention)	<b>Units</b>	
	<b>NTU</b>	
	<b>FNU</b>	
	<b>ASBC</b>	
	<b>EBC</b>	
	<b>16:02:19</b>	<b>01/04/05</b>

Note: If Attenuation is chosen as a calibration curve. The result will be reported in FAU (Formazin Attenuation Units).

6. Press <b>◀</b> to exit to a previous menu or make another menu selection or press <b>OFF</b> to turn the meter off.		

## SELECTING A TURBIDITY CALIBRATION CURVE

1. Press <b>ON</b> to turn the meter on.	 <b>1.3</b>	
--	---	--

2. Scroll down and then press <b>*IOK</b> to select <b>Options</b> .	<b>Main Menu</b>	
	<b>Measure</b>	
	<b>Data Logging</b>	
	<b>* Options</b>	
	<b>16:02:19</b>	<b>01/04/05</b>

3. Scroll down and then press <b>*IOK</b> to select <b>Turbidity</b> .	<b>Options</b>
	<b>Averaging</b>
	<b>* Turbidity</b>
	<b>Date/Time</b>
	<b>Language</b>
	<b>16:02:19</b> <b>01/04/05</b>

4. Scroll down and then press <b>*IOK</b> to select <b>Calibration</b> .	<b>Turbidity</b>
	<b>Units</b>
	<b>* Calibration</b>
	<b>16:02:19</b> <b>01/04/05</b>

5. Scroll down and then press <b>*IOK</b> to select a <b>Calibration</b> curve. Select a calibration option based on the composition of the standards that will be used to calibrate the meter. Available options are: <b>Formazin</b> , <b>Japan Standard</b> , <b>Attenuation</b> .	<b>Turbidity</b>
	<b>Units</b>
	<b>* Calibration</b>
	<b>16:02:19</b> <b>01/04/05</b>

For the most accurate results, the Attenuation option should be chosen when samples are over 500 NTU. The range for the Attenuation option is 40–4000 NTU.

<b>Calibration</b>
<b>* Formazin</b>
<b>Japan Standard</b>
<b>Attenuation</b>
<b>16:02:19</b> <b>01/04/05</b>

The Japan Standard calibration mode should be used only with Japanese Polystyrene Standards (0–100 NTU).

Note: StablCal® standards below 50 NTU should not be used to calibrate the 2020. The diluent has a different refractive index than traditional formazin standards and will affect the results.

6. Press <b>◀</b> to exit to a previous menu or make another menu selection or press <b>OFF</b> to turn the meter off.	



## AVERAGING

The averaging option allows the user to average multiple readings. This option will improve the accuracy of samples with readings that may tend to drift with time. When the two, five or ten reading options have been selected, the meter will show a running average of the readings that have been taken until the final average is displayed. The default setting is disabled. To change the setting:

1. Press **ON** to turn the meter on.



1.3

2. Scroll down and then press **\*IOK** to select **Options**.

### Main Menu

Measure  
Data Logging  
\* Options

16:02:19

01/04/05

3. Press **\*IOK** to select **Averaging**.

### Options

\* Averaging  
Turbidity  
Date/Time  
Language

16:02:19

01/04/05

4. Scroll down and then press **\*IOK** to select an averaging option.

Available options are:  
**Disabled, 2 Measurements,  
5 Measurements,  
10 Measurements.**

Note: The \* is displayed next to the current setting.

### Averaging

Disabled  
\* 2 Measurements  
5 Measurements  
10 Measurements

16:02:19

01/04/05

*continued next page...*

- Press **◀** to exit to a previous menu or make another menu selection or press **OFF** to turn the meter off.

*Note:* When the Averaging option is selected, it will take longer to get the final result and more power will be used.

## SETTING THE DATE AND TIME

- Press **ON** to turn the meter on.



1.3

- Scroll down and then press **\*IOK** to select **Options**.

Main Menu

Measure  
Data Logging  
\* Options

16:02:19

01/04/05

- Scroll down and then press **\*IOK** to select **Date/Time**.

Options

Averaging  
Turbidity  
\* Date/Time  
Language

16:02:19

01/04/05

- Press **\*IOK** to select **Set Date** or scroll down and then press **\*IOK** to select **Set Time** or **Date Format**.

Date/Time

\* Set Date  
Set Time  
Date Format

16:02:19

01/04/05

5. When setting the time or the date, use the ▼ or ▲ to change the highlighted number on the display. Press **\*IOK** to accept the value and move to the next value.

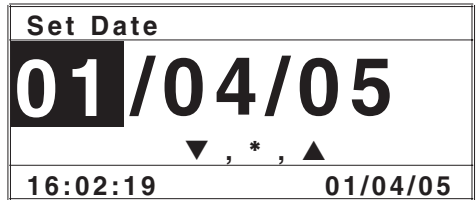
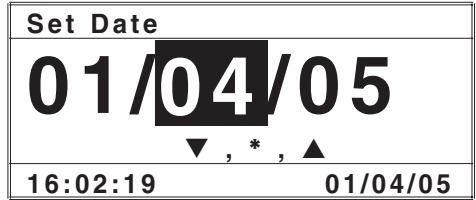
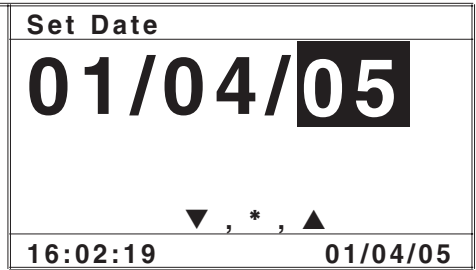

When choosing a date format, use the ▼ or ▲ to select a date format. Press **\*IOK** to accept the format.

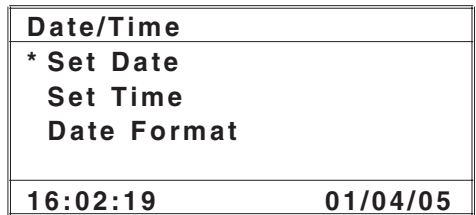

6. Press ◀ to exit to a previous menu or make another menu selection or press **OFF** to turn the meter off.

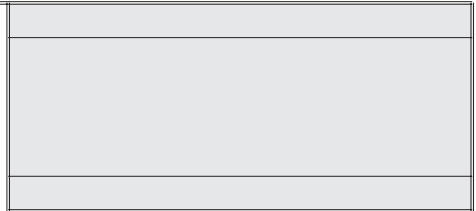

## SELECTING A LANGUAGE

---

The default setting is English. To change the setting:

1. Press **ON** to turn the meter on.

The logo for LaMotte, featuring a stylized 'L' symbol followed by the brand name 'LaMotte' in a bold, sans-serif font.

1.3

2. Scroll down and then press **\*IOK** to select **Options**.

**Main Menu**

**Measure**

**Data Logging**

**\* Options**

16:02:19

01/04/05

3. Scroll down and then press **\*IOK** to select **Language**.

**Options**

**Averaging**

**Turbidity**

**Date Time**

**\* Language**

16:02:19

01/04/05

4. Scroll down and then press **\*IOK** to select a language.  
Available languages are: **English**, **French**, **Spanish**, **Japanese** (Kana), **Portuguese**, **Italian**.

**Language**

**\* English**

**Frances**

**Español**

**Japanese**

16:02:19

01/04/05

5. Press **◀** to exit to a previous menu or make another menu selection or press **OFF** to turn the meter off.

## SETTING AUTO SHUTDOWN

The power saving Auto Shutdown feature will turn the meter off when a button has not been pushed for a set amount of time. The default setting is disabled. To change the setting:

1. Press **ON** to turn the meter on.



1.3

2. Scroll down and then press **\*IOK** to select **Options**.

Main Menu

Measure  
Data Logging  
\* Options

16:02:19

01/04/05

3. Scroll down and then press **\*IOK** to select **Auto Shutdown**.

Options

Turbidity  
Date/Time  
Language  
\* Auto Shutdown

16:02:19

01/04/05

4. Scroll up and then press **\*IOK** to select a shutdown time.  
Available options are: **5 minutes**, **10 minutes**, **30 minutes**, **Disabled**.

Auto Shutdown

\* 5 Minutes  
10 Minutes  
30 Minutes  
Disabled

16:02:19

01/04/05

5. Press **◀** to exit to a previous menu or make another menu selection or press **OFF** to turn the meter off.

## DATA LOGGING

The default setting for the data logger is start (on). The meter will log the last 4004 data points.

1. Press **ON** to turn the meter on.



2. Scroll down and press **\*IOK** to select **Data Logging**.

<b>Main Menu</b>	
<b>Measure</b>	
<b>* Data Logging</b>	
<b>Options</b>	
<b>16:02:19</b>	<b>01/04/05</b>

3. Press **\*IOK** to view the last data point that was logged.

<b>Data Logging</b>	
<b>* View</b>	
<b>Stop</b>	
<b>Erase</b>	
<b>16:02:19</b>	<b>01/04/05</b>

4. Press **▼** or **▲** to scroll through the saved data points.

<b>304 / 304</b>	
<b>1.58 NTU</b>	
<b>Turbidity (F)</b>	
<b>16:26:58</b>	<b>09/11/04</b>
<b>16:02:19</b>	<b>01/04/05</b>

Note: If the data logger is empty because it has never been used or has just been erased, the view function will not work.

Or scroll down and press **\*IOK** to select **Stop** or **Start** to stop or start the data logging feature.

<b>Data Logging</b>	
<b>View</b>	
<b>* Stop</b>	
<b>Erase</b>	
<b>16:02:19</b>	<b>01/04/05</b>

Or scroll down and press **\*IOK** to select **Erase** to empty all logged data points from the memory.

<b>Data Logging</b>	
View * Start Erase	
<b>16:02:19</b>	<b>01/04/05</b>

<b>Data Logging</b>	
View Stop * Erase	
<b>16:02:19</b>	<b>01/04/05</b>

5. Press **OFF** to turn the meter off or press **◀** to exit to a previous menu or make another menu selection.

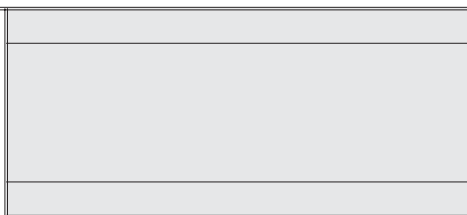

---

## TUBE POSITIONING RING

### The Tube Positioning Ring

---

To put a ring on a tube, remove the cap from the tube.

The tube positioning ring has two tapered notches and one squared-off notch. Place the ring on the tube with the squared-off notch closest to the top of the tube and tapered notches closer to the bottom of the tube. Align the single, squared-off notch with the vertical, white indexing line that is printed on the tube. Place the tube flat on a hard surface and firmly press the ring onto the tube with equal pressure distributed along the top of the ring.

To remove a ring, invert the uncapped tube on a soft surface, such as a paper towel. Press down on the ring with equal pressure distributed around the ring.

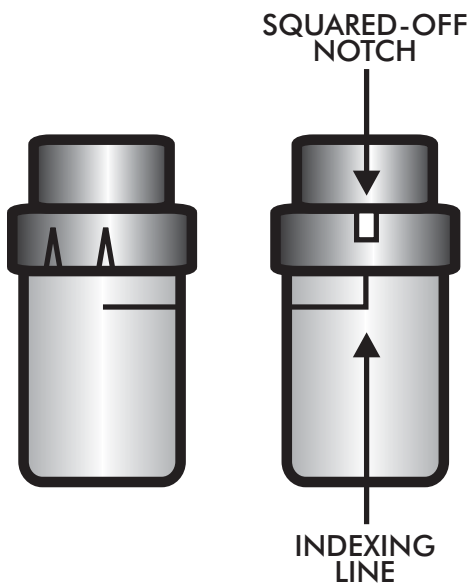

---

## CALIBRATION & ANALYSIS

The default units are NTU and the default calibration curve is formazin. When **(F)** is displayed in the upper right corner of the display, this indicates that the meter is in the formazin mode. For the most accurate results, a user calibration should be performed. The Attenuation calibration option should be used when samples are over 500 NTU. The Japan Standard calibration mode should be used only with Japanese Polystyrene Standards (0–100 NTU). To change the settings see the *Set Up* instructions (see page 22).



## ANALYSIS

1. Press **\*ION** to turn the meter on.



1.3

2. Press **\*IOK** to select **Measure**.

Main Menu

\* Measure  
Data Logging  
Options

16:02:19

01/04/05

3. Rinse a clean tube (0290) three times with the blank.  
  
Below 1 NTU – The meter should be blanked with a 0 NTU Primary Standard or prepared turbidity-free (<0.1 NTU) water. For the most accurate results, use the same tube for the blank and the sample.

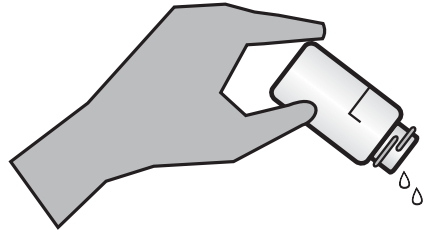

4. Fill the tube to the fill line with the blank. Pour the blank down the inside of the tube to avoid creating bubbles.

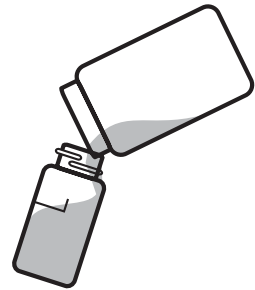

5. Dry the tube with a lint-free cloth. Put on a dry positioning ring. Cap the tube. Wipe the tube thoroughly again with a lint-free cloth.

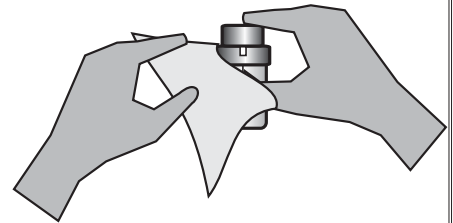

6. Open the meter lid. Insert the tube into the chamber. Align the index notch on the positioning ring with the index arrow on the meter. Close the lid.

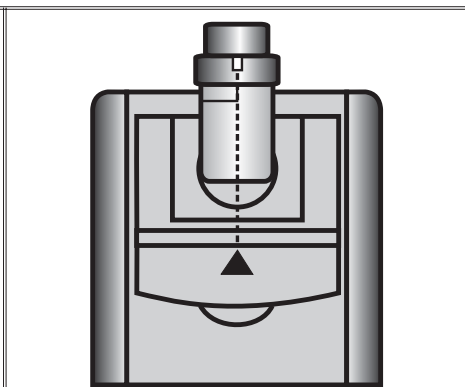

7. Press **\*IOK** to select **Scan Blank**. Remove the tube.

**NOTE:** For the best accuracy, especially at low turbidity, see Tip 17 on page 43.

**Turbidity** (F)

\* Scan Blank ▼

16:02:19 01/04/05

8. Rinse a clean tube (0290), or the same tube, three times with the water to be tested. Avoid spilling water on the outside of the tube. **IMPORTANT:** While the tube is inverted, wipe the lip of the tube to remove droplets of liquid that may be present. This will prevent liquid from being trapped under the ring when the tube is returned to an upright position.

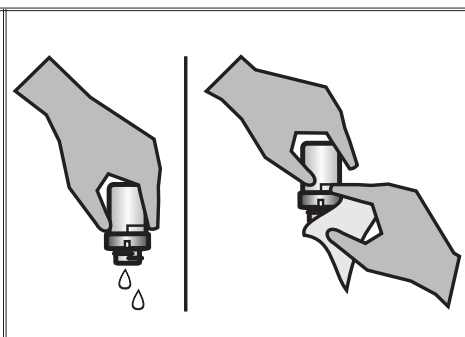

9. Fill the tube to the fill line with the sample. Pour the sample down the inside of the tube to avoid creating bubbles.

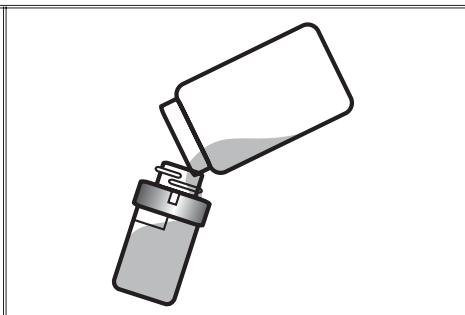

10. Cap the tube. Wipe the tube thoroughly again with a lint-free cloth.

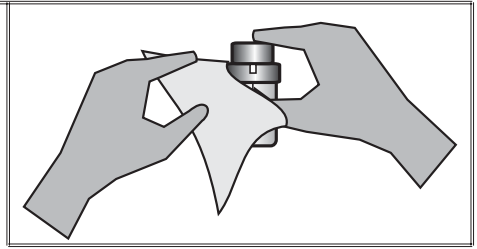

11. Open the meter lid. Insert the tube into the chamber. Align the index notch on the positioning ring with the index arrow on the meter. Close the lid.

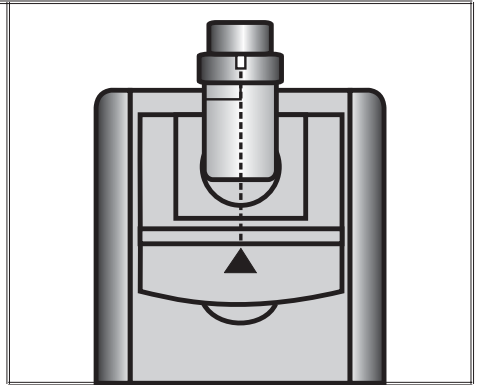

12. Press **\*IOK** to select **Scan Sample**.

<b>Turbidity</b>	<b>(F)</b>
* <b>Scan Sample</b>	▼
<b>16:02:19</b>	<b>01/04/05</b>

13. Record the result.

<b>Turbidity</b>	<b>(F)</b>
<b>0.54</b>	<b>NTU</b>
* <b>Scan Sample</b>	▼
<b>16:02:19</b>	<b>01/04/05</b>

14. Press **OFF** to turn the meter off or press **◀** to exit to a previous menu or make another menu selection.

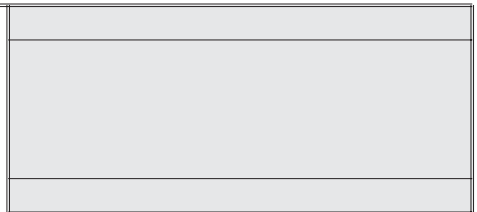

*Note:* The meter will remember the last scanned blank reading. It is not necessary to scan a blank each time the test is performed. To use the previous blank reading, instead of scanning a new one, scroll to Scan Sample and proceed. For the most accurate results, the meter should be blanked before each test and the same tube with tube positioning ring should be used for the blank and the reacted sample.

## Dilution Procedures

---

If a sample is encountered that is more than 4000 NTU, a careful dilution with 0 NTU or very low turbidity water will bring the sample into an acceptable range. However, there is no guarantee that halving the concentration will exactly halve the NTU value. Particulates often react in an unpredictable manner when diluted.

## Turbidity-Free Water

---

The definition of low turbidity and turbidity-free water has changed as filter technology has changed and nephelometric instruments have become more sensitive. At one time turbidity-free water was defined as water that had passed through a 0.6 micron filter. Now 0.1 micron filters are available and higher purity water is possible. Water that has been passed through a 0.1 micron filter could be considered particle free and therefore turbidity free, 0 NTU water. Turbidity is caused by scattered light. Therefore, low turbidity water is water without any particles that scatter a measurable amount of light. But water that passed through a 0.1 micron filter may still have detectable light scatter with modern instruments. This light scattering can be the result of dissolved molecules or sub-micron sized particles that can not be filtered out of the water. Because there may still be a small amount of scattered light from dissolved molecules, high purity water is often called low turbidity water and assigned a value of 0.01 or 0.02 NTU. However, because this water is used as a baseline to compare to sample water, the difference between the sample and the low turbidity or turbidity-free water will be the same whether it is called 0.00 NTU or 0.02 NTU. For design simplicity the 2020 uses the term turbidity-free water and the value of 0.00 NTU.

## Preparation of Turbidity-Free Water

---

A 0 NTU Standard (Code 1480) is included with the meter. An accessory package (Code 4185) is available for preparing turbidity-free water for blanking the meter and dilution of high turbidity samples.

The preparation of turbidity-free water requires careful technique. Introduction of foreign matter will affect the turbidity reading. A filtering device with a special membrane filter is used to prepare turbidity-free water. The filter, filter holder and syringe must be conditioned by forcing at least two syringes full of deionized water through the filtering apparatus to remove foreign matter. The first and second rinses should be discarded. Turbidity-free water as prepared below may be stored in the dark at room temperature in a clean glass bottle with a screw cap and used as required. The storage container should be rinsed thoroughly with filtered deionized water before filling. The water should be periodically inspected for foreign matter in bright light.

## PROCEDURE

---

1. Remove the plunger from the syringe (0943). Attach the filter to the bottom of the syringe.

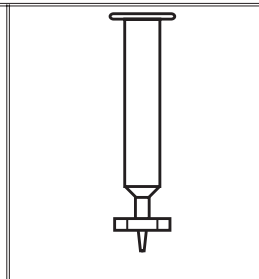

2. Pour approximately 50 mL of deionized water into the barrel of the syringe. Insert the plunger. Exert pressure on the plunger to slowly force the water through the filter. Collect water in the clean storage container. Rinse walls of the container then discard this rinse water.

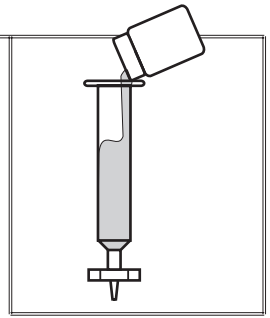

3. Remove the filter from the syringe. Remove the plunger from the barrel. (This step is required to prevent rupturing the filter by the vacuum that would be created when the plunger is removed.)

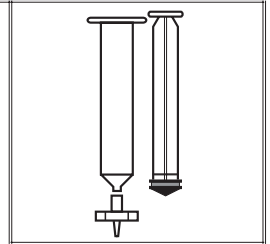

4. Replace the filter and repeat step 2 for a second rinse of the syringe and storage container.

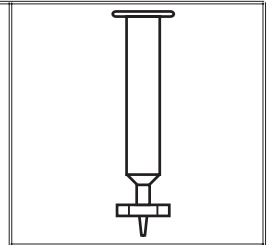

5. Remove the filter from the syringe. Remove the plunger from the barrel. Replace the filter and fill the syringe with approximately 50 mL of deionized water. Filter the water into the storage container and save this turbidity-free water.

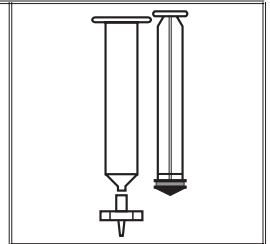

6. Repeat Step 5 until the desired amount of turbidity-free water has been collected.

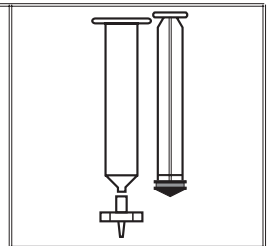

## Turbidity Standards

Only use AMCO or formazin standards with the 2020. StablCal® standards below 50 NTU should not be used to calibrate the 2020. The diluent used in StablCal® standards has a different refractive index than traditional formazin standards and will affect the results. The concentration of the calibration standard should be similar to the expected concentration of samples that will be tested. The following standards are available from LaMotte Company:

1480	0 NTU Standard, 60 mL (EPA and ISO)
1484	1 NTU Standard, 60 mL (EPA)
1481	1 NTU Standard, 60 mL (ISO)
1485	10 NTU Standard, 60 mL (EPA)
1482	10 NTU Standard, 60 mL (ISO)
1486	100 NTU Standard, 60 mL (EPA)
1483	100 NTU Standard, 60 mL (ISO)

## CALIBRATION PROCEDURE

1. Press **\*ION** to turn the meter on.

The LaMotte logo features a stylized 'L' symbol to the left of the brand name 'LaMotte' in a bold, sans-serif font.

1.3

2. Press **\*IOK** to select **Measure**.

Main Menu

\* Measure  
Data Logging  
Options

16:02:19

01/04/05

3. Rinse a clean tube (0290) three times with the blank.

Below 1 NTU – The meter should be blanked with a 0 NTU Primary Standard or prepared turbidity-free (<0.1 NTU) water. For the most accurate results, use the same tube for the blank and the sample.

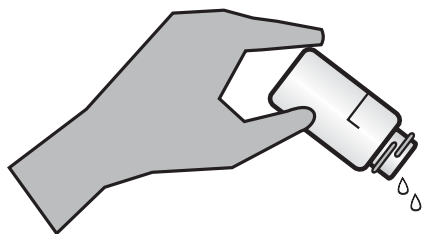

4. Fill the tube to the fill line with the blank. Pour the blank down the inside of the tube to avoid creating bubbles. Cap the tube.

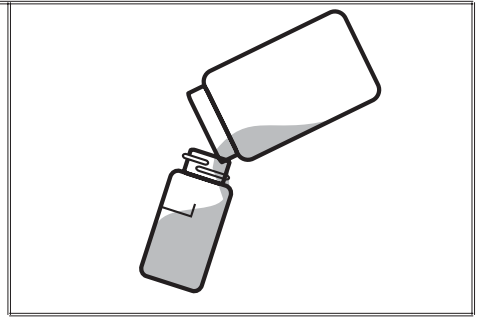

5. Dry the tube with a lint-free cloth. Put on a dry positioning ring. Cap the tube. Wipe the tube thoroughly again with a lint-free cloth.

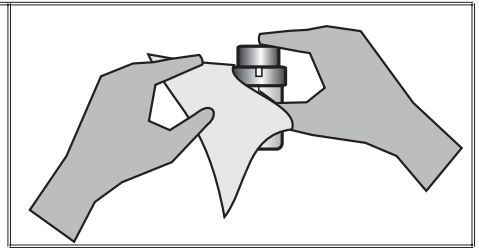

6. Open the meter lid. Insert the tube into the chamber. Align the index notch on the positioning ring with the index arrow on the meter. Close the lid.

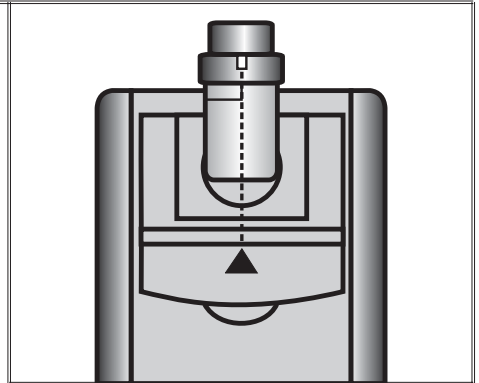

7. Press **\*IOK** to select **Scan Blank**. Remove the tube.

**NOTE:** For the best accuracy, especially at low level turbidity, see **Tip 17** on page 43.

<b>Turbidity</b>	<b>(F)</b>
<b>* Scan Blank</b>	
<b>16:02:19</b>	<b>01/04/05</b>

8. Rinse a clean tube (0290), or the same tube, three times with the standard. Avoid spilling standard on the outside of the tube.

**IMPORTANT:** While the tube is inverted, wipe the lip of the tube to remove droplets of liquid that may be present. This will prevent liquid from being trapped under the ring when the tube is returned to an upright position.

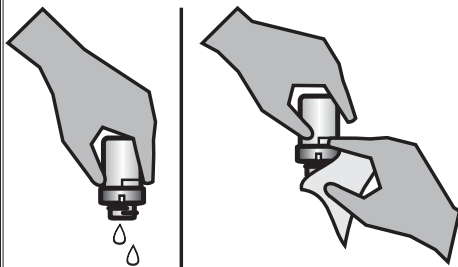

9. Fill the tube to the fill line with the standard. Pour the standard down the inside of the tube to avoid creating bubbles. Cap the tube.

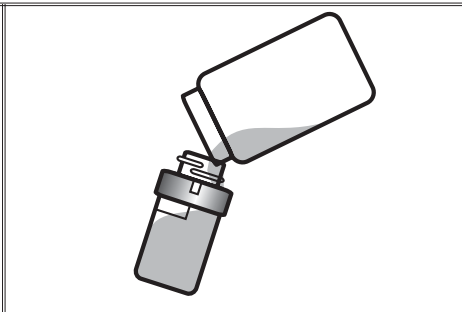

10. Wipe the tube thoroughly again with a lint-free cloth.

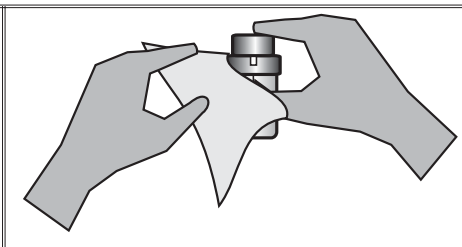

11. Open the meter lid. Insert the tube into the chamber. Align the index notch on the positioning ring with the index arrow on the meter. Close the lid.

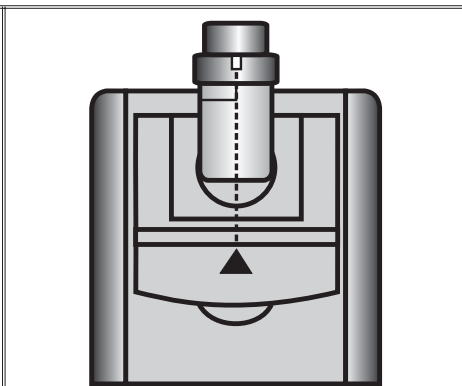



12. Press **\*IOK** to select **Scan Sample**.

<b>Turbidity</b>	<b>(F)</b>
<b>* Scan Sample</b>	
<b>16:02:19</b>	<b>01/04/05</b>

13. Observe the result.

<b>Turbidity</b>	<b>(F)</b>
<b>0.54</b>	<b>NTU</b>
<b>* Scan Sample</b> ▼	
<b>16:02:19</b>	<b>01/04/05</b>

14. Press ▼ and then press **\*IOK** to select **Calibrate**.

<b>Turbidity</b>	<b>(F)</b>
<b>0.54</b>	<b>NTU</b>
<b>* Calibrate</b> ▼	
<b>16:02:19</b>	<b>01/04/05</b>

15. Use the ▼ or ▲ to change the highlighted digits on the display to match the concentration of the turbidity standard. Press **\*IOK** to accept a digit and move to the next digit.

<b>Calibrate</b>	
<b>00.54</b>	
▼, *, ▲	
<b>16:02:19</b>	<b>01/04/05</b>

<b>Calibrate</b>	
<b>00.54</b>	
▼, *, ▲	
<b>16:02:19</b>	<b>01/04/05</b>

<b>Calibrate</b>	
<b>00.54</b>	
▼, *, ▲	
<b>16:02:19</b>	<b>01/04/05</b>

<b>Calibrate</b>	
<b>00.50</b>	
▼, *, ▲	
<b>16:02:19</b>	<b>01/04/05</b>

Calibrate	
00.50	
▼, *, ▲	
16:02:19	01/04/05

16. When the value on the display matches the concentration of the turbidity standard, press the **\*IOK** to select **Set**.

Or press ▼ press **\*IOK** to return the meter to the default setting.

Calibrate	
00.50	
* Set	▼
16:02:19	01/04/05

Calibrate	
01.15	
* Default	▲
16:02:19	01/04/05

17. Press **\*IOK** to proceed to Turbidity analysis. Press **OFF** to turn the meter off or press ◀ to exit to a previous menu or make another menu selection.

*Note:* The meter will remember the last scanned blank reading. It is not necessary to scan a blank each time the test is performed. To use the previous blank reading, instead of scanning a new one, scroll to Scan Sample and proceed. For the most accurate results, the meter should be blanked before each test and the same tube with tube positioning ring should be used for the blank and the reacted sample.

## Testing Tips

---

1. Samples should be collected in a clean glass or polyethylene container.
2. Samples should be analyzed as soon as possible after collection.
3. Gently mix sample by inverting before taking a reading but avoid introducing air bubbles.
4. For the most precise results, follow the recommended procedure for wiping a filled tube before placing it in the meter chamber. Invert tube very slowly and gently three times to mix the sample. Surround the tube with a clean, lint-free cloth. Press the cloth around the tube. Rotate the tube in the cloth three times to assure that all areas of the tube have been wiped.
5. Discard tubes that have significant scratches and imperfections in the light pass zones. (Central zone between bottom and fill line).
6. When reading very low turbidity samples, do not use tubes or caps that have been used previously with high turbidity samples.
7. Use the averaging option for low level measurements of turbidity.
8. The meter should be placed on a surface that is free from vibrations. Vibrations can cause high readings.
9. Turbidity readings will be affected by electric fields around motors.
10. Carbon in the sample will absorb light and cause low readings.
11. Excessive color in a sample will absorb light and cause low readings. The user should verify if a certain level of color will cause a significant error at the level of turbidity being tested.
12. Observe shelf life recommendations for turbidity standards.
13. Do not use silicone oil on tubes when testing turbidity with the 2020.
14. When testing at low concentrations use the same tube for the blank and the sample.
15. Always use the positioning ring. Always insert tube into the meter chamber with the same amount of pressure and to the same depth.
16. Occasionally clean the chamber with a damp lint-free wipe, followed by an alcohol dampened wipe. A clean chamber and tubes are essential for reliable results.
17. For the greatest accuracy during the calibration procedure, be sure that after the meter is blanked and the blank is scanned as a sample, the reading is 0.00. If not, reblank the meter and scan the blank again until it reads 0.00. When scanning the calibration standards as the sample, scan the calibration standard three times removing the tube from the chamber after each scan. The readings should be consistent. Use the last consistent reading to calibrate the meter. If the readings are not consistent, avoid using an aberrant reading to calibrate the meter.

## TROUBLESHOOTING GUIDE

### Error Messages

Err1	Very Low battery. Replace battery or switch to AC power. Press back arrow (◀) to back out. Scan sample again. Replace battery as soon as possible.
Err2	The meter can not be calibrated outside of the allowable range of the displayed reading. Confirm that standard was made correctly. The displayed reading can only be adjusted to $\pm 50\%$ of the factory calibration.
Err3	Meter can not be calibrated with a zero sample. Calibrate the meter with a sample other than zero.
Err4	Processing error. Scan sample again.
Err5	No blank reading. The meter has never been blanked for this test factor. Blank meter.
Err6	Internal mathematical error. Re-blank the meter and rescan the sample.
Err7	Configuration error. Call LaMotte Tech Service. Meter may have to be returned for repairs.
low battery	Low battery. Change battery.

### TROUBLESHOOTING

PROBLEM	REASON	SOLUTION
Erroneous readings	Measurement was taken with lid open.	Close lid. Read again.
> on display	Over range.	The sample is outside of the acceptable range. Dilute sample and test again.
Meter freezes	Lid was opened when reading was being taken.	Close lid. Read again. Unplug adapter. Plug adapter in to reset.
Lost in meter menus in another language	Reset to factory settings.	Hold down * <b>IOK</b> and press <b>ON</b> . Release both buttons. Press * <b>IOK</b> to select the default settings. Meter will turn off and the factory settings will be restored.

### Stray Light

The accuracy of readings on the 2020 should not be affected by stray light. Make sure that the sample compartment lid is always fully closed when taking readings.

---

## PC LINK

The 2020 may be interfaced with any Windows-based computer by using the LaMotte SMARTLink 2 Program and Interface Cable (Code 1912-3 with 3.5 inch disk or Code 1912-CD with compact disk). The program will store test information and results in a database. The meter may also be interfaced with an RS232 serial printer, using an interface cable (Code 1772) and setting the printer configuration to the Output as described below.

### Output

---

RS232 compatible, asynchronous serial, 9600 baud, no parity, 8 data bits, 1 stop bit.

### Computer Connection

---

RS232 interface connection, 8 pin mini-DIN/9 pin F D-submin. (Order Interface Cable Code 1772).

---

## BATTERY OPERATION

The 2020 may be operated on battery power or using an AC adapter. If using the meter as a bench top unit, use the AC adapter if possible. If using the meter only on battery power, always keep a spare battery on hand.

### Replacing the Battery

---

The 2020 uses a standard 9-volt alkaline battery that is available worldwide. The battery compartment is located on the bottom of the case.

#### To replace the battery:

---

1. Open the battery compartment lid.
2. Remove the battery and disconnect the battery from the polarized plug.
3. Carefully connect the new battery to the polarized plug and insert it into the compartment.
4. Close the battery compartment lid.

---

## MAINTENANCE

### Cleaning

---

Clean meter with a damp, lint-free cloth.

**DO NOT ALLOW WATER TO ENTER THE METER CHAMBER OR ANY OTHER PARTS OF THE METER.**

Clean meter chamber and lenses over LEDs with a lint-free cloth slightly dampened with alcohol.

### Repairs

---

Should it be necessary to return the meter for repair or servicing, pack the meter carefully in a suitable container with adequate packing material. A return authorization number must be obtained from LaMotte Company by calling 800-344-3100 (US only) or 410-778-3100, faxing 410-778-6394, or emailing [tech@lamotte.com](mailto:tech@lamotte.com). Often a problem can be resolved over the phone or by email. If a return of the meter is necessary, attach a letter with the return authorization number, meter serial number, a brief description of problem and contact information including phone and FAX numbers to the shipping carton. This information will enable the service department to make the required repairs more efficiently.

### Meter Disposal

---

Waste Electrical and Electronic Equipment (WEEE)

Natural resources were used in the production of this equipment. This equipment may contain materials that are hazardous to health and the environment. To avoid harm to the environment and natural resources, the use of appropriate take-back systems is recommended. The crossed out wheeled bin symbol on the meter encourages you to use these systems when disposing of this equipment.



Take-back systems will allow the materials to be reused or recycled in a way that will not harm the environment. For more information on approved collection, reuse, and recycling systems contact your local or regional waste administration or recycling service.





LaMotte Company • PO Box 329 • 802 Washington Avenue  
Chestertown • Maryland • 21620 • USA

USA 800-344-3100 • 410-778-3100 • fax 410-778-6394 • [www.lamotte.com](http://www.lamotte.com)

Code 1979-MN