

Multi 350i

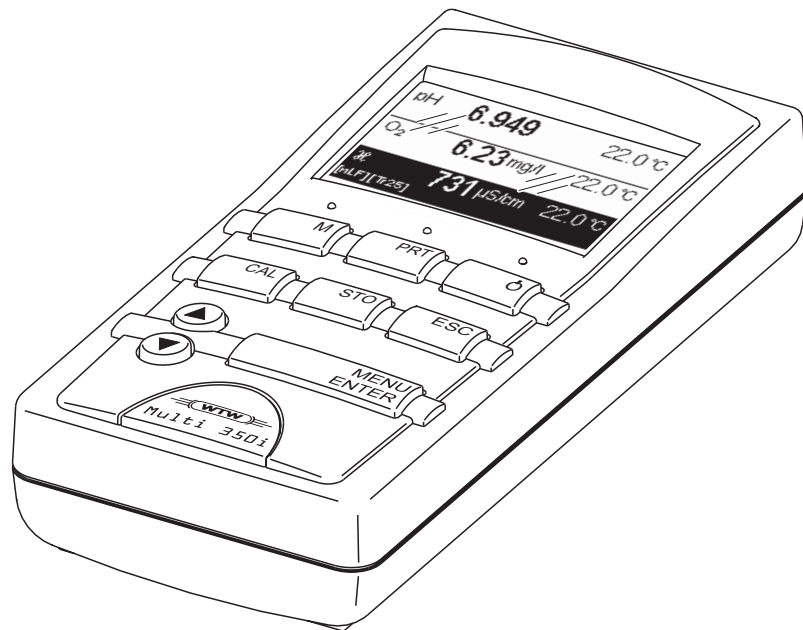

pH / ISE / DO / conductivity measuring instrument

**Accuracy when
going to press**

The use of advanced technology and the high quality standard of our instruments are the result of a continuous development. This may result in differences between this operating manual and your instrument. Also, we cannot guarantee that there are absolutely no errors in this manual. Therefore, we are sure you will understand that we cannot accept any legal claims resulting from the data, figures or descriptions.

Currentness of firmware

The process of consistently improving our products includes the continuous further development of instrument firmware. The current Multi 350i firmware is available on the Internet. It can easily be downloaded on your meter using the enclosed AK 340/B cable and a PC. For more detailed information, refer to the appendix of this operating manual or to the Internet under <http://www.WTW.com>.

Copyright

© Weilheim 2005, WTW GmbH
Reproduction in whole - or even in part - is prohibited without the express written permission of WTW GmbH, Weilheim.
Printed in Germany.

1	Overview	3
1.1	General features	3
1.2	SETs of equipment	4
1.3	Keypad	6
1.4	Display	7
1.5	Socket field	7
2	Safety	9
2.1	Authorized use	9
2.2	General safety instructions	10
3	Commissioning	11
3.1	Scope of delivery	11
3.2	Power supply	11
3.3	Initial commissioning	12
4	Operation	13
4.1	Switching on the measuring instrument	13
4.2	General operating principles	14
4.2.1	Operating modes	14
4.2.2	Navigation	15
4.2.3	Example 1 on navigation: Setting the language	17
4.2.4	Example 2 on navigation: Setting the date and time	19
4.3	System settings (system menu)	21
4.3.1	<i>Data storage</i>	21
4.3.2	<i>Display</i>	21
4.3.3	<i>System</i>	23
4.4	pH value / ORP voltage	25
4.4.1	General information	25
4.4.2	Measuring the pH value	27
4.4.3	Measuring the ORP voltage	28
4.4.4	Settings for pH and ORP measurements	29
4.4.5	pH calibration	30
4.4.6	Carrying out the TEC and NIST/DIN calibration	34
4.4.7	Carrying out a ConCal calibration	38
4.5	Ion concentration	41
4.5.1	General information	41
4.5.2	Measuring the ion concentration	42
4.5.3	Settings for ISE measurements	43
4.5.4	Calibrating for ISE measurements	43
4.6	Dissolved oxygen	49
4.6.1	General information	49
4.6.2	Measuring	50
4.6.3	Settings for DO sensors	51
4.6.4	DO calibration	53

4.7	Conductivity	58
4.7.1	General information	58
4.7.2	Measuring	59
4.7.3	Temperature compensation	60
4.7.4	Settings for conductivity measuring cells	61
4.7.5	Determining the cell constant (calibration in the control standard)	63
4.8	Data storage	66
4.8.1	Manual data storage	67
4.8.2	Automatic data storage at intervals	68
4.8.3	Editing the measured value storage	70
4.8.4	Erasing the measured value storage	73
4.8.5	Displaying and outputting calibration records	74
4.9	Transmitting data (RS 232 interface)	76
4.9.1	Options for data transmission	76
4.9.2	Connecting a PC/external printer	77
4.9.3	Operation with MultiLab pilot	77
4.10	Reset	78
4.10.1	Resetting the sensor settings	78
4.10.2	Resetting the system settings	79
5	Maintenance, cleaning, disposal	81
5.1	Maintenance	81
5.2	Cleaning	81
5.3	Disposal	81
6	What to do if...	83
6.1	pH and ORP measurement	83
6.2	ISE measurement	85
6.3	DO measurement	86
6.4	Conductivity measurement	87
6.5	General errors	88
7	Technical data	89
7.1	General data	89
7.2	Measuring ranges, resolution, accuracy	91
7.2.1	pH/ORP	91
7.2.2	ISE	91
7.2.3	Dissolved oxygen	92
7.2.4	Conductivity	93
8	Lists	95
9	Index	101
	Appendix: Firmware Update	103

1 Overview

1.1 General features

The Multi 350i compact precision handheld meter enables you to carry out pH measurements, ISE measurements, dissolved oxygen (DO) measurements and conductivity measurements quickly and reliably. The Multi 350i handheld meter provides the maximum degree of operating comfort, reliability and measuring certainty for all applications.

The proven MultiCal[®] and OxiCal[®] calibration procedures and the procedures to determine/set up the cell constant support you in your work with the meter. The special AutoRead function enables precise measurements.

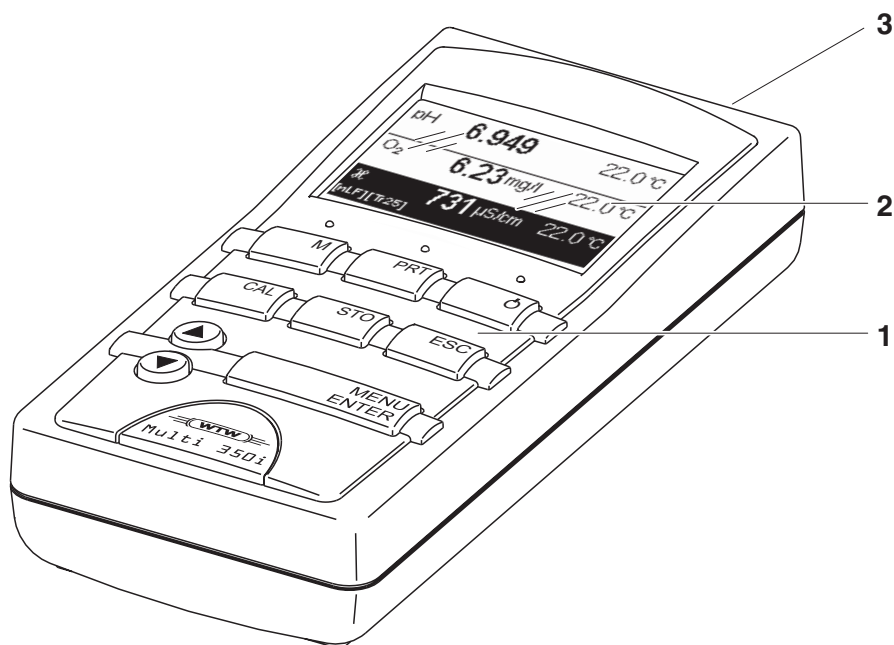

1	Keypad
2	Display
3	Socket field



Note

If you need further information or application notes, you can obtain the following material from WTW:

- Application reports
- Primers
- Safety datasheets.

You will find information on available literature in the WTW catalog or via the Internet.

1.2 SETs of equipment

The measuring instrument is also available as part of individual SETs of equipment.

You will find additional information on this and other accessories in the WTW catalog or via the Internet.

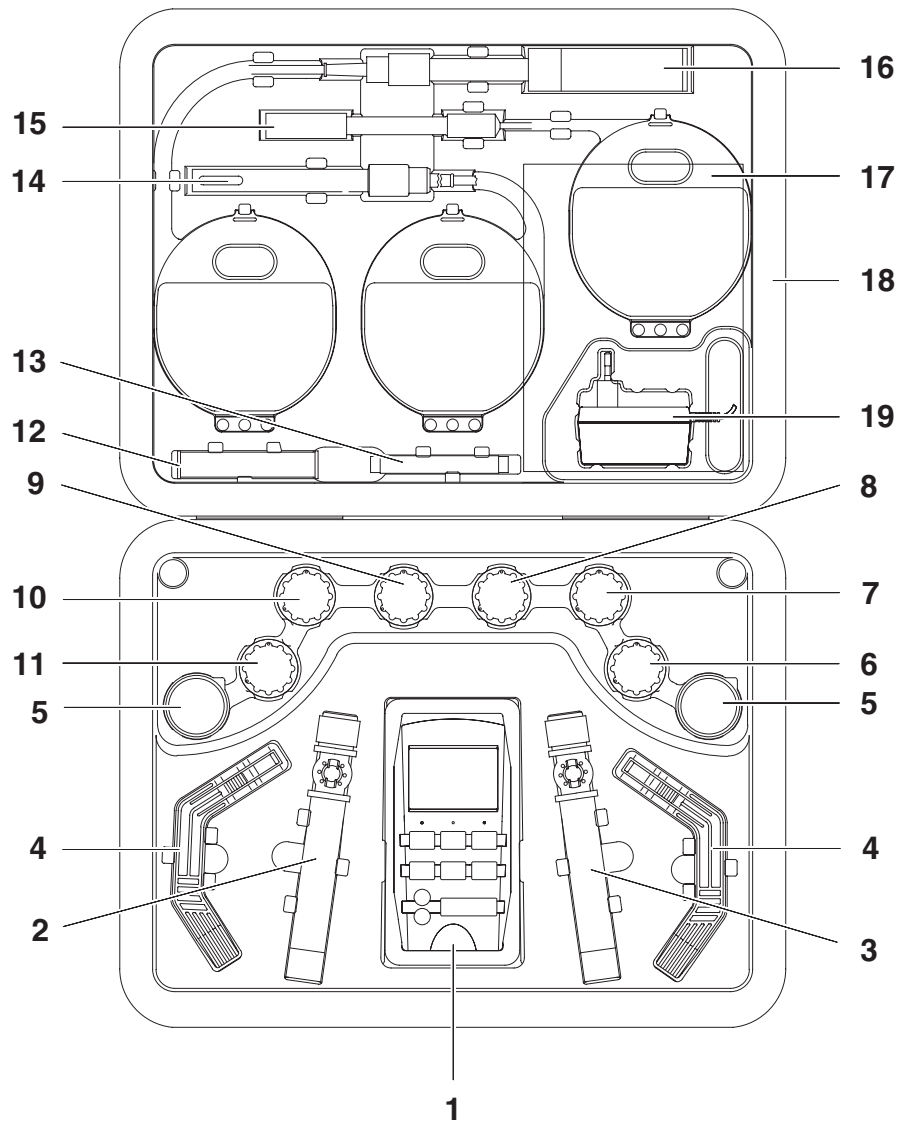







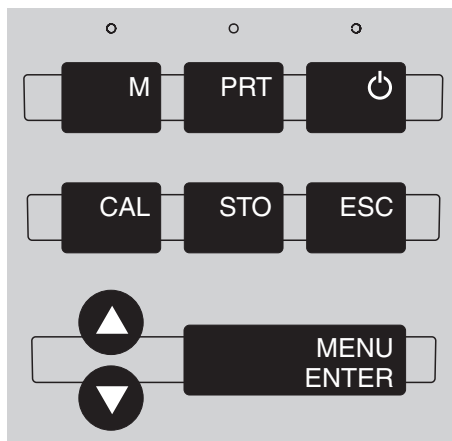

Set (sample configuration):

1	Multi 350i measuring instrument, carrying strap with 2 carrying clips, armoring
2	Cond/Oxi beaker with beaker clip
3	pH beaker
4	Stand
5	Plastic beaker, 50 ml
6	Storing solution for pH electrodes
7	50 ml pH buffer solution, STP 4
8	50 ml pH buffer solution, STP 7
9	Calibration and control standard for conductivity measuring cells, 50 ml
10	50 ml ELY/G electrolyte solution for DO sensors
11	50 ml RL/G cleaning solution for DO sensors
12	Exchange membrane caps for DO sensors (3 pieces)
13	SF 300 polishing strip for the maintenance of DO sensors
14	Conductivity measuring cell
15	pH combination electrode
16	DO sensor
17	Operating manual + short operating manual
18	Equipment case
19	Plug-in power supply unit
	MultiLab pilot CD-ROM

1.3 Keypad

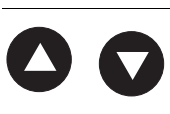

Key functions

	Select the measured variable <M> : <ul style="list-style-type: none"> – pH value / ORP / ion concentration – DO concentration / DO saturation / DO partial pressure – Conductivity / specific resistance / salinity / TDS
	Output display contents to RS232 interface (e.g. print) <PRT>
	Switch the measuring instrument on/off <ON/OFF>
	Calibrate the currently selected measured variable <CAL>
	Store a measured value <STO>
	Switch to the next higher menu level / cancel input <ESC>
	Set values <▲>, <▼>
	Open a menu / confirm input <MENU/ENTER>

1.4 Display

The graphical display can indicate up to three measuring windows at the same time. The illumination enables to read the display even in the darkness. You can modify the display to meet your requirements in multiple ways.

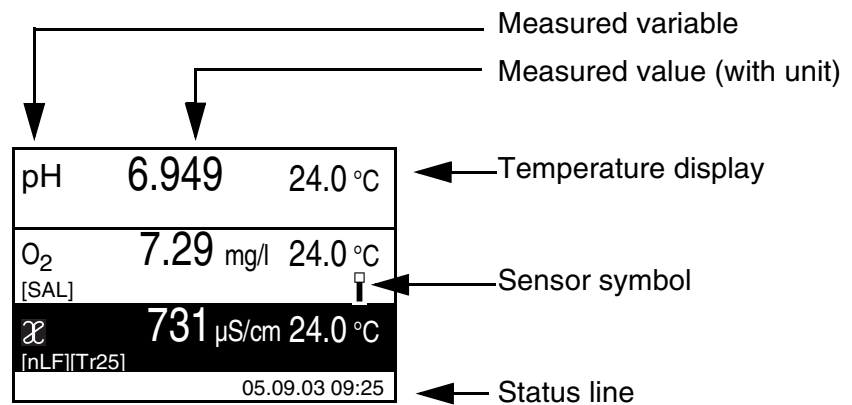

1.5 Socket field

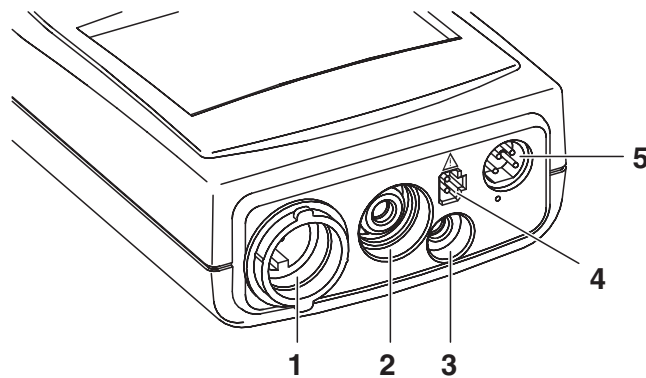

1	DO sensor or conductivity measuring cell or combined conductivity / DO sensor
2	pH electrode or ISE combination electrode
3	pH temperature sensor
4	Plug-in power supply unit
5	RS232 serial interface

2 Safety

This operating manual contains basic instructions that you must follow during the commissioning, operation and maintenance of the measuring instrument. Consequently, all responsible personnel must read this operating manual before working with the measuring system. The operating manual must always be available within the vicinity of the measuring system.

Target group

The measuring instrument was developed for work in the field and in the laboratory.

Thus, we assume that, as a result of their professional training and experience, the operators will know the necessary safety precautions to take when handling chemicals.

Safety instructions

The individual chapters of this operating manual use the following safety instruction to indicate various types of danger:



Caution

indicates instructions that must be followed precisely in order to avoid the possibility of slight injuries or damage to the instrument or the environment.

Further notes



Note

indicates notes that draw your attention to special features.



Note

indicates cross-references to other documents, e.g. operating manuals.

2.1 Authorized use

The authorized use of the measuring instrument consists exclusively of the:

- pH and ORP measurement
- ISE measurement
- measurement of dissolved oxygen (DO) and
- conductivity measurement

in the field and laboratory.

The technical specifications as given in chapter 7 TECHNICAL DATA must be observed. Only the operation and running of the measuring instrument according to the instructions given in this operating manual is authorized. Any other use is considered to be **unauthorized**.

2.2 General safety instructions

This instrument is built and inspected according to the relevant guidelines and norms for electronic measuring instruments (see chapter 7 TECHNICAL DATA).

It left the factory in a safe and secure technical condition.

Function and operating safety

The smooth functioning and operational safety of the measuring instrument can only be guaranteed if the generally applicable safety measures and the specific safety instructions in this operating manual are followed during operation.

The smooth functioning and operational safety of the measuring instrument can only be guaranteed under the environmental conditions that are specified in chapter 7 TECHNICAL DATA.

If the instrument was transported from a cold environment to a warm environment, the formation of condensate can lead to the faulty functioning of the instrument. In this event, wait until the temperature of the instrument reaches room temperature before putting the instrument back into operation.

Safe operation

If safe operation is no longer possible, the instrument must be taken out of service and secured against inadvertent operation!

Safe operation is no longer possible if the measuring instrument:

- has been damaged in transport
- has been stored under adverse conditions for a lengthy period of time
- is visibly damaged
- no longer operates as described in this manual.

If you are in any doubt, please contact the supplier of the instrument.

Obligations of the purchaser

The purchaser of this measuring instrument must ensure that the following laws and guidelines are observed when using dangerous substances:

- EEC directives for protective labor legislation
- National protective labor legislation
- Safety regulations
- Safety datasheets of the chemical manufacturers.

3 Commissioning

3.1 Scope of delivery

- Multi 350i handheld measuring instrument with 4 rechargeable batteries, 1.2 V type AA in the instrument
- Plug-in power supply with Euro plug, exchange plugs for USA, UK, and Australia are enclosed
- Operating manual and short operating manual
- MultiLab pilot CD-ROM

3.2 Power supply

Mains operation and charging the batteries

You can operate the measuring instrument either with the built-in rechargeable batteries or with the plug-in power supply. The plug-in power supply supplies the measuring instrument with low voltage (9 V DC). At the same time, the rechargeable batteries are charged. The batteries are charged even when the instrument is switched off.

Charging time of the batteries

approx. 36 hours. The *LoBat* display indicator appears when the batteries are nearly empty and have to be charged as soon as possible.



Caution

The line voltage at the operating site must lie within the input voltage range of the original plug-in power supply (see chapter 7 TECHNICAL DATA).



Caution

Use original plug-in power supplies only (see chapter 7 TECHNICAL DATA).



Note

The batteries should not be completely discharged. If you do not operate the instrument for a longer period of time you should charge the batteries every six months.

Automatic switchoff

The instrument has an automatic switchoff function in order to save the batteries (see section 4.3.3).

Display illumination with battery operation

During battery operation, the measuring instrument automatically switches off the display illumination if no key has been pressed for 15 seconds. The illumination is switched on with the next keystroke again. The display illumination can be switched off completely.

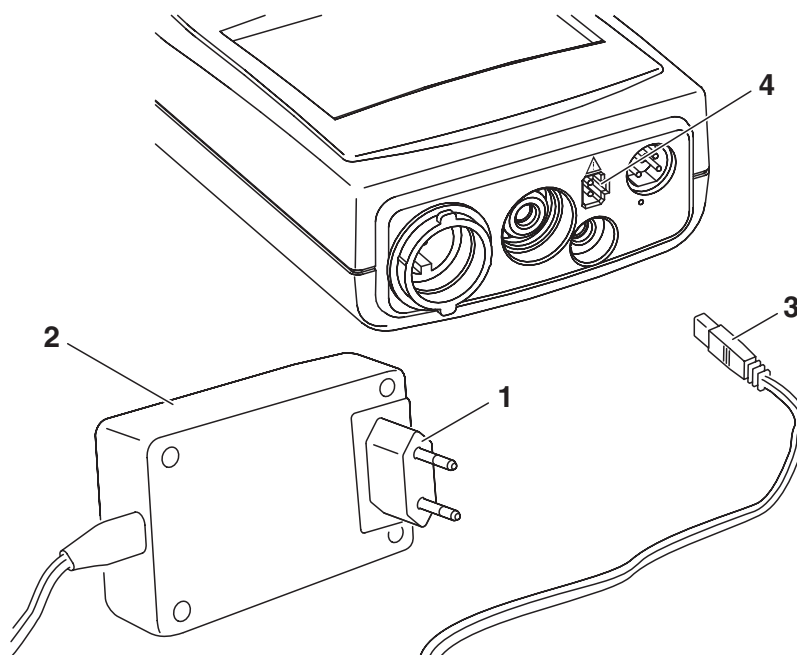

1	If necessary, replace the Euro plug (1) on the plug-in power supply unit (2) by the country-specific plug suitable for your country.
2	Connect the plug (3) to the socket (4) of the measuring instrument.
3	Connect the plug-in power supply unit to an easily accessible mains socket.

3.3 Initial commissioning

Perform the following activities:

- For mains operation and charging the batteries: Connect the plug-in power supply unit (see section 3.2 POWER SUPPLY).
- Switch on the measuring instrument (see section 4.1)
- Set the language (see section 4.2.3)
- Set the date and time (see section 4.2.4)



Note

When you set the language, date and time according to the mentioned sections of this operating manual you will quickly be familiar with the simple operation of the Multi 350i.

4 Operation

4.1 Switching on the measuring instrument

Switching on

Press the <ON/OFF> key.
The measured value display appears.

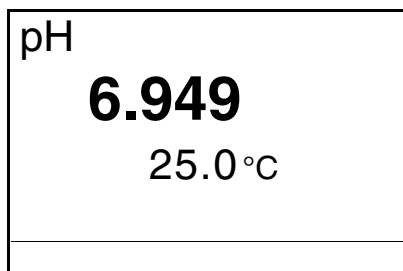

Switching off

Press the <ON/OFF> key.

Automatic switchoff

The instrument has an automatic switchoff function in order to save the batteries (see section 4.3.3). The automatic switchoff switches off the measuring instrument if no key is pressed for an adjustable period.

The automatic switchoff is not active

- if the power is supplied by the plug-in power supply unit,
- if the *Automatic data storage* function is active, or with automatic data transmission
- if the communication cable and a PC with a running communication program are connected,
- if the printer cable is connected (for external printers).

Display illumination with battery operation

During battery operation, the measuring instrument automatically switches off the display illumination if no key has been pressed for 15 seconds. The illumination is switched on with the next keystroke again.

4.2 General operating principles

This section contains basic information of the operation of the Multi 350i.

Operating elements, display

An overview of the operating elements and the display is given in section 1.3 and section 1.4.

Operating modes, navigation

An overview of the operating modes and navigation of the Multi 350i is given in section 4.2.1 and section 4.2.2.

4.2.1 Operating modes

The instrument has the following operating modes:

- Measuring
The measuring data of one to three sensors is displayed in the measured value display
- Calibration
The course of a calibration with calibration information, functions and settings is displayed
- Data storage
The measuring instrument stores measuring data automatically or manually
- Transmitting data
The measuring instrument transmits measuring data and calibration records to the serial interface automatically or manually.
- Setting
The system menu or a sensor menu with submenus, settings and functions is displayed

4.2.2 Navigation

Measured value display

In the measured value display, you can

- select a measuring window with <▲> <▼> and open the relevant measuring menu by shortly pressing <MENU/ENTER>.
- open the system menu with the sensor-independent settings by pressing <MENU/ENTER> for a long time (approx. 1 s).
- change the display in the selected measuring window (e. g. pH <-> mV) by pressing <M>.

Menus and dialogs

The menus for settings and dialogs in courses contain further sub-menus. The selection is made with the <▲> <▼> keys. The current selection is displayed in reverse video.

- Submenus

The name of the submenu is displayed at the upper edge of the frame. Submenus are opened by confirming with <MENU/ENTER>. Example:

System	
General	
Interface	
Clock function	
Reset	

- Settings

Settings are indicated by a colon. The current setting is displayed on the right-hand side. The setting mode is opened with <MENU/ENTER>. Subsequently, the setting can be changed with <▲> <▼> and <MENU/ENTER>.

Example:

System	
Language:	Deutsch
Beep:	Off
Illumination:	On
Contrast:	48 %
Temperature unit:	°C
Switchoff time:	30 min

- Functions

Functions are designated by the name of the function. They are immediately carried out by confirming with **<MENU/ENTER>**.

Example: Display the *Calibration record* function.

pH	
Calibration type:	TEC
Calibration interval:	7 d
Unit for slope:	mV/pH
Calibration record	
■ 2.00 4.01 7.00 10.01	

Messages

Information or operating instructions are designated by the ■ symbol. They cannot be selected.

Example:

pH	
■ Buffer recognition TEC	
■ Immerse sensor in buffer 1	
Set temperature: 25 °C	
Continue	

**Note**

The principles of navigation are explained in the two following sections by reference of examples:

- Set the language (see section 4.2.3)
- Set the date and time (see section 4.2.4).

4.2.3 Example 1 on navigation: Setting the language

- 1 Press the **<ON/OFF>** key.
The measured value display appears.
The instrument is in the measuring ode.

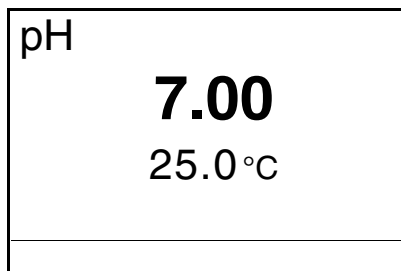

- 2 Open the system menu by pressing **<MENU/ENTER>** for a long time (approx. 1 s).
The instrument is in the setting mode.

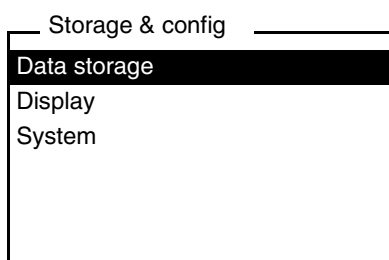

- 3 Select the *System* submenu with **<▲>** **<▼>**.
The current selection is displayed in reverse video.
- 4 Open the *System* submenu with **<MENU/ENTER>**.

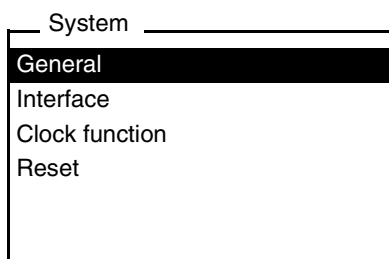

- 5 Select the *General* submenu with **<▲>** **<▼>**.
The current selection is displayed in reverse video.

- 6 | Open the *General* submenu with **<MENU/ENTER>**.

System	
Language:	Deutsch
Beep:	Off
Illumination:	On
Contrast:	48 %
Temperature unit:	°C
Switchoff time:	30 min

- 7 | Open the setting mode for the *Language* with **<MENU/ENTER>**.

System	
Language:	Deutsch
Beep:	Off
Illumination:	On
Contrast:	48 %
Temperature unit:	°C
Switchoff time:	30 min

- 8 | Select the required language with **<▲>** **<▼>**.

- 9 | Confirm the setting with **<MENU/ENTER>**.
The setting becomes active the next time the system menu is called up.

- 10 | To make further settings, switch to the next higher menu level with **<ESC>**.
or
Switch to the measured value display with **<M>**.
The instrument is in the measuring mode.

4.2.4 Example 2 on navigation: Setting the date and time

The measuring instrument has a clock with a date function. The date and time are indicated in the status line of the measured value display. The indication can be switched off. When storing measured values and calibrating, the current date and time are automatically stored as well.

The correct setting of the date and time and date format is important for the following functions and displays:

- Current date and time
- Calibration date
- Identification of stored measured values.

Therefore, check the time at regular intervals.



Note

After a fall of the supply voltage (empty batteries), the date and time are reset to 01.01.2003, 00:00 hours.

Setting the date, time and date format

The data format can be switched from the display of day, month, year (*dd.mm.yy*) to the display of month, day, year (*mm/dd/yy* or *mm.dd.yy*).

1	In the measured value display: Open the system menu by pressing <MENU/ENTER> for a long time (approx. 1 s). The instrument is in the setting operating mode.
2	Select and confirm the <i>System / Clock function</i> menu with <▲> <▼> and <MENU/ENTER> . The setting menu for the date and time opens up.
3	Select and confirm the <i>Time</i> menu with <▲> <▼> and <MENU/ENTER> . The seconds are highlighted.

System	
Time:	14:53:40
Date:	30.10.03
Date format:	dd.mm.yy

4	Change and confirm the setting with <▲> <▼> and <MENU/ENTER> . The minutes are highlighted.
---	---

5	Change and confirm the setting with <▲> <▼> and <MENU/ENTER>. The hours are highlighted.
6	Change and confirm the setting with <▲> <▼> and <MENU/ENTER>. The time is set.
7	If necessary, set the <i>Date</i> and <i>Date format</i> . The setting is made similarly to that of the time.
8	If necessary, select and set the <i>Date</i> with <▲> <▼> and <MENU/ENTER>.
9	To make further settings, switch to the next higher menu level with <ESC>. or Switch to the measured value display with <M>. The instrument is in the measuring operating mode.

4.3 System settings (system menu)

The system menu comprises the following settings:

- *Data storage* (see section 4.3.1)
- *Display* (see section 4.3.2)
- *System* (see section 4.3.3).

4.3.1 Data storage

This menu contains all functions to display, edit and erase stored measured values and calibration records.



Note

Detailed information on the data storage functions of the Multi 350i is given in section 4.8.

4.3.2 Display

With the aid of *Display* submenu, you can modify the measured value display to meet your requirements. When doing so, you can display or hide the following elements:

- pH/ISE measuring window
- DO measuring window
- Conductivity measuring window
- Date indication in the status line
- Time indication in the status line



Note

When several sensors or multiple sensors (e.g. ConOx) are connected, all available measured variables are automatically displayed. If you do not wish to have all measured values displayed, you can hide measured values of individual sensors.

Settings To open the system menu in the measured value display, press the **<MENU/ENTER>** key for approx. 1 s. After completing the settings, switch to the measured value display with **<M>**.

Menu item	Setting	Description
<i>Display / Time</i>	<i>On</i> <i>Off</i>	Display of the time in the system status line
<i>Display / Date</i>	<i>On</i> <i>Off</i>	Display of the date in the system status line
<i>Display / pH</i>	<i>On</i> <i>Off</i>	Display of the pH/ISE measuring window. This menu item is only visible if the electrode and an additional sensor are connected.
<i>Display / O2</i>	<i>On</i> <i>Off</i>	Display of the DO measuring window. This menu item is only visible if a DO sensor is connected.
<i>Display / Cond</i>	<i>On</i> <i>Off</i>	Display of the conductivity measuring window. This menu item is only visible if a conductivity measuring cell is connected.

4.3.3 System

Overview The following sensor-independent instrument features can be adjusted in the system menu/*System* and its submenus:

- Menu language
- Beep on keystroke
- Display illumination
- Display contrast
- Unit of the temperature display
- Interval of the automatic switchoff
- Data interface
- Clock and date function
- Function to reset all sensor-independent system settings to the default condition

Settings To open the system menu in the measured value display, press the **<MENU/ENTER>** key for approx. 1 s. After completing the settings, switch to the measured value display with **<M>**.

Menu item	Setting	Description
<i>System / General / Language</i>	<i>Deutsch English (further)</i>	Select the menu language
<i>System / General / Beep</i>	<i>On Off</i>	Switch on/off the beep on keystroke
<i>System / General / Illumination</i>	<i>On Off</i>	Switching the display illumination on/off
<i>System / General / Contrast</i>	<i>0 ... 100 %</i>	Changing the display contrast
<i>System / General / Temperature unit</i>	<i>°C °F</i>	Temperature unit, degrees Celsius or degrees Fahrenheit. All temperatures are displayed with the selected unit.
<i>System / General / Switchoff time</i>	<i>10, 15, 30, 45, 60 min</i>	The automatic switchoff automatically switches the measuring instrument off if no entry is made for a specified period of time (switchoff interval). This saves the batteries.

Menu item	Setting	Description
<i>System / Interface / Baud rate</i>	<i>1200, 2400, 4800, 9600, 19200</i>	Baud rate of the data interface
<i>System / Interface / Output format</i>	<i>ASCII CSV</i>	Output format for data transmission For details, see section 4.9
<i>System / Interface / Header</i>	<i>Yes No</i>	Option for output in csv format. "Yes" creates a header in the table.
<i>System / Clock function</i>	<i>Time Date Date format</i>	Settings of time and date. For details, see section 4.2.4
<i>System / Reset</i>	-	Resets the system settings to the default values. For details, see section 4.10.2

4.4 pH value / ORP voltage

4.4.1 General information

You can measure the following variables:

- pH value []
- ORP [mV]



Temperature measurement

Caution

When connecting an earthed PC/printer, measurements cannot be performed in earthed media as incorrect values would result. The RS232 interface is not galvanically isolated.

For reproducible pH measurements, it is essential to measure the temperature of the test sample.

You have the following possibilities of measuring the temperature:

- Automatic measurement of the temperature by the temperature sensor (NTC30 or Pt1000) integrated in electrode.
- Measurement of the temperature by the integrated temperature sensor of a simultaneously connected DO sensor or conductivity measuring cell in the test sample.
- Manual determination and input of the temperature.

The measuring instrument recognizes whether a suitable sensor is connected and automatically switches on the temperature measurement.

The display of the temperature indicates the active temperature measuring mode:

Temperature sensor		Resolution of the temp. display	Mode
<i>pH</i>	<i>Cond or Oxi</i>		
yes	-	0.1 °C	Automatic with pH temperature sensor
yes	yes	0.1 °C	
-	-	1 °C	Manual
-	yes	0.1 °C, <i>measured temperature value flashes</i>	The temperature value of the second sensor (Cond or Oxi) in the same test sample is taken over for pH measurement*

* If you do not wish that, you can:

- either disconnect the 2nd sensor and use the manual temperature input or
- use an electrode with a temperature sensor.

Preparatory activities

Perform the following preparatory activities when you want to measure:

1	Connect a pH or ORP electrode to the measuring instrument. The pH/ISE measuring window is displayed.
2	If necessary, select the pH or mV display with <M>.
3	Adjust the temperature of the solutions and measure the current temperature if the measurement is made without a temperature sensor.
4	Calibrate or check the measuring instrument with the electrode.

4.4.2 Measuring the pH value

1	Perform the preparatory activities according to section 4.6.1.
2	Immerse the pH electrode in the test sample.

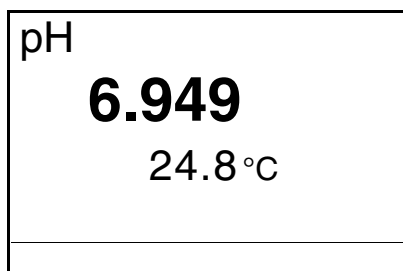

3	Select the pH or mV display with <M>.
---	---------------------------------------

AutoRead (Drift control)

The AutoRead function (drift control) continually checks the stability of the measurement signal. The stability has a considerable impact on the reproducibility of measured values. The display of the measured variable flashes until a stable measured value is available.

Criteria

With identical measurement conditions, the following applies:

Measured variable	Reproducibility	Response time
pH value	Better than 0.01	> 30 seconds

4.4.3 Measuring the ORP voltage



Note

ORP electrodes are not calibrated. However, you can check ORP electrodes using a test solution.

- | | |
|---|--|
| 1 | Perform the preparatory activities according to section 4.6.1. |
| 2 | Submerge the ORP electrode in the sample. |

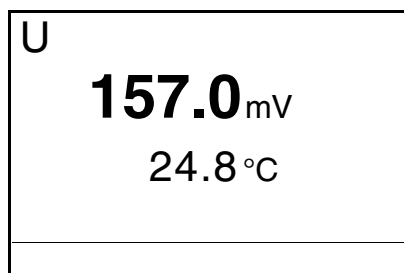

- | | |
|---|---------------------------------|
| 3 | Select the mV display with <M>. |
|---|---------------------------------|

**AutoRead
(drift control)**

The AutoRead function (drift control) continually checks the stability of the measurement signal. The stability has a considerable impact on the reproducibility of measured values. The display of the measured variable flashes until a stable measured value is available.

Criteria

With identical measurement conditions, the following applies:

Measured variable	Reproducibility	Response time
ORP voltage	better than 0.6 mV	> 30 seconds

4.4.4 Settings for pH and ORP measurements

Overview The following settings are possible for pH and ORP measurements:

- Resolution
- *Calibration interval*
- Buffers for calibration
- *Unit for slope*
- *Calibration record* (display)

Settings The settings are made in the measuring menu of the pH/ORP measurement. To open the settings, activate the relevant measuring window in the measured value display and press the **<MENU/ENTER>** key shortly. After completing the settings, switch to the measured value display with **<M>**.

Menu item	Possible setting	Description
<i>Calibration / Calibration interval</i>	<i>1 ... 999 d</i>	<i>Calibration interval</i> for the pH electrode (in days). The measuring instrument reminds you to calibrate regularly by the flashing sensor symbol in the measuring window.
<i>Calibration / Calibration type</i>	<i>TEC NIST/DIN ConCal</i>	Buffer sets to be used for pH calibration. For details, see section 4.4.5.
<i>Calibration / Unit for slope</i>	<i>mV/pH %</i>	Unit of the slope. The % display refers to the Nernst slope of -59.16 mV/pH (100 x determined slope/Nernst slope).
<i>Calibration / Calibration record</i>	-	Displays the calibration record of the last calibration.
<i>Man. temperature</i>	<i>-20 ... +130 °C</i>	Entry of the manually determined temperature. For measurements without temperature sensor only.
<i>Reset</i>	-	Resets all sensor settings to the delivery condition (see section 4.10.1).
<i>High resolution</i>	<i>On Off</i>	Resolution of the pH display: <i>On</i> = 0.001 <i>Off</i> = 0.01

4.4.5 pH calibration

Why calibrate?

pH electrodes age. This changes the asymmetry (zero point) and slope of the pH electrode. As a result, an inexact measured value is displayed. Calibration determines the current values of the asymmetry and slope of the electrode and stores them in the measuring instrument. Thus, you should calibrate at regular intervals.

When to calibrate?

- After connecting another electrode
- When the sensor symbol flashes:
 - after the calibration interval has expired
 - after a voltage interruption (empty batteries)

Buffer sets for calibration

You can use the buffer sets quoted in the table for an automatic calibration. The pH values are valid for the specified temperature values. The temperature dependence of the pH values is taken into account during calibration.

Buffer set	Name on the display	pH values at 25 °C
Technical buffer solutions	<i>TEC</i>	2.00 4.01 7.00 10.01
<i>NIST/DIN</i> buffer solutions	<i>NIST/DIN</i>	1.679 4.006 6.865 9.180 12.454
(user-defined single-point or two-point calibration)	<i>ConCal</i>	pH 7.0 ± 0.5 and any other buffer solution



Note

The buffers are selected in the sensor menu (setting, *Calibration type*, see section 4.4.4).

Calibration points

Calibration can be performed using one, two or three buffer solutions in any order (single-point, two-point or three-point calibration). The measuring instrument determines the following values and calculates the calibration line as follows:

	Determined values	Displayed calibration data
1-point	<i>ASY</i>	<ul style="list-style-type: none"> ● Asymmetry = <i>ASY</i> ● Slope = Nernst slope (-59.16 mV/pH at 25 °C)
2-point	<i>ASY</i> <i>SLO</i>	<ul style="list-style-type: none"> ● Asymmetry = <i>ASY</i> ● Slope = <i>SLO</i>
3-point	<i>ASY</i> <i>SLO</i>	<ul style="list-style-type: none"> ● Asymmetry = <i>ASY</i> ● Slope = <i>SLO</i> <p>The calibration line is calculated by linear regression.</p>

**Note**

You can display the slope in the units, mV/pH or % (see section 4.3.3).

AutoRead

In calibration, the AutoRead function is automatically activated. The current AutoRead measurement can be terminated at any time (accepting the current value).

Calibration record

When finishing a calibration, the new calibration values are displayed as an informative message (■ symbol) first. Then you can decide whether you want to take over these values of the new calibration or whether you want to continue measuring with the old calibration data. After accepting the new calibration values the calibration record is displayed.

Display calibration data and output to interface



You can have the data of the last calibration displayed (see section 4.8.5). Subsequently, you can transmit the displayed calibration data to the interface, e. g. to a printer or PC, with the <PRT> key.

Note





The calibration record is automatically transmitted to the interface after calibrating.

Sample record:

```
03.11.03  07:14
CALIBRATION pH
03.11.03  07:10:45
Multi 350i ser. no.  12345678
Cal. interval      7 d
AutoCal TEC
Buffer 1           4.01
Buffer 2           7.00
Buffer 3           10.01
Voltage 1          184.0 mV      24.0 °C
Voltage 2          0.0 mV      24.0 °C
Voltage 3          -177.0 mV     24.0 °C
Slope              -60.2 mV/pH
Asymmetry          3.0 mV
Sensor             +++
```

Calibration evaluation

After calibrating, the measuring instrument automatically evaluates the calibration. The asymmetry and slope are evaluated separately. The worse evaluation of both is taken into account. The evaluation appears on the display and in the calibration record.

Display	Calibration record	Asymmetry [mV]	Slope [mV/pH]
	+++	-15 ... +15	-60.5 ... -58
	++	-20 ... +20	-58 ... -57
	+	-25 ... +25	-61 ... -60.5 or -57 ... -56
	-	-30 ... +30	-62 ... -61 or -56 ... -50
Clean the electrode according to the electrode operating manual			
<i>Error</i>	<i>Error</i>	< -30 or > 30	< -62 or > -50
Perform error elimination according to chapter 6 WHAT TO DO IF...			

Preparatory activities

Perform the following preparatory activities when you want to calibrate:

1	Connect the pH electrode to the measuring instrument. The pH/ISE measuring window is displayed.
2	Keep the buffer solutions ready. Adjust the temperature of the buffer solutions, or measure the current temperature, if you measure without a temperature sensor.

4.4.6 Carrying out the TEC and NIST/DIN calibration

The two calibration procedures only differ in the usage of different buffer sets (see section 4.4.5). Make sure that the *Calibration type* is correctly set in the sensor menu (see section 4.4.4).

For this procedure, use any one, two or three WTW technical buffer solutions in ascending or descending order.

The *TEC* calibration is described below. With the *NIST/DIN* calibration, the *NIST/DIN* buffer recognition and different nominal buffer values are displayed. Apart from that, the procedure is identical.



Note

The TEC calibration for pH 10.01 is optimized for the WTW technical buffer solution TEP 10 Trace or TPL 10 Trace. Other buffer solutions can lead to an erroneous calibration. The correct buffer solutions are given in the WTW catalog or in the Internet.

1	In the measured value display, select the pH or mV measuring window with <▲> <▼> and <M>.
2	Start the calibration with <CAL>. The calibration display appears.

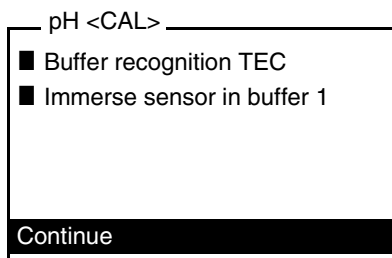

3	Immerse the electrode in buffer solution 1.
4	If the <i>Set temperature</i> menu item appears, measure and enter the temperature of the buffer manually (measurement without temperature sensor).
5	Select <i>Continue</i> with <▲> <▼> and press <MENU/ENTER>. The buffer is measured. The measured value is checked for stability (AutoRead).

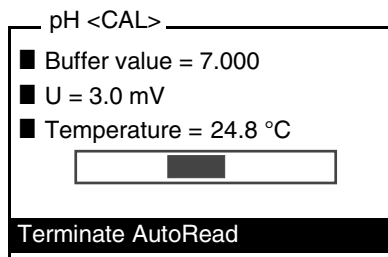

Displayed:

- Recognized nominal buffer value (referring to 25 °C)
- current electrode voltage
- current temperature value

- 6 Wait for the end of the AutoRead measurement or accept the calibration value with <MENU/ENTER>. The calibration display for the next buffer appears.

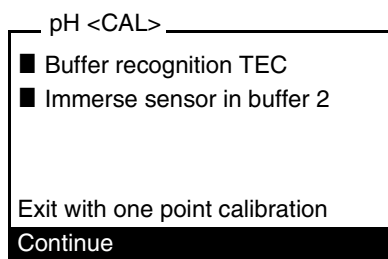

- 7 For single-point calibration, select *Exit with one point calibration* with <▲> <▼> and confirm with <MENU/ENTER>. The calibration is completed as a single-point calibration. The new calibration values are displayed as a message (■). You have the following options:
- Accept the new calibration values with <MENU/ENTER>. Subsequently, the calibration record is displayed and output to the interface at the same time.
 - To switch to the measured value display without accepting the new calibration values, press <M> or <ESC>.



Note

For **single-point calibration**, the instrument uses the Nernst slope (-59.16 mV/pH at 25 °C) and determines the asymmetry of the electrode.

Continuing for two-point calibration
(Calibration type TEC)

8	Thoroughly rinse the electrode with distilled water.
9	Immerse the electrode in buffer solution 2.
10	If the <i>Set temperature</i> menu item appears, measure and enter the temperature of the buffer manually (measurement without temperature sensor).
11	Select <i>Continue</i> with <▲> <▼> and press <MENU/ENTER>. The buffer is measured. The measured value is checked for stability (AutoRead).

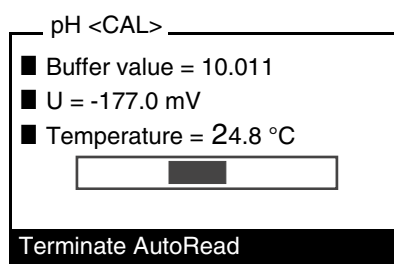

12	Wait for the end of the AutoRead measurement or <i>Terminate AutoRead</i> and accept the calibration value with <MENU/ENTER>. The calibration display for the next buffer appears.
----	--

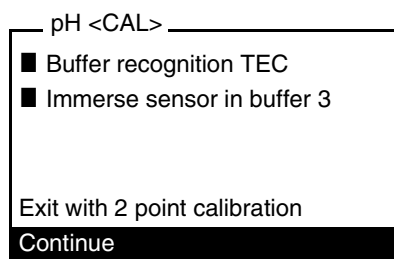

13	For two-point calibration, select <i>Exit with 2 point calibration</i> with <▲> <▼> and confirm with <MENU/ENTER>. The calibration is completed as a two-point calibration. The new calibration values are displayed as a message (■). You have the following options: <ul style="list-style-type: none"> ● Accept the new calibration values with <MENU/ENTER>. Subsequently, the calibration record is displayed and output to the interface at the same time. ● To switch to the measured value display <u>without</u> accepting the new calibration values, press <M> or <ESC>.
----	---

Continuing for three-point calibration
(*Calibration type TEC*)

14	Thoroughly rinse the electrode with distilled water.
15	Immerse the electrode in buffer solution 3.
16	If necessary, measure the temperature of buffer 3 manually, then enter and confirm it with <▲> <▼> and <MENU/ENTER> in the <i>Set temperature</i> setting.
17	Select <i>Continue</i> with <▲> <▼> and press <MENU/ENTER>. The buffer is measured. The measured value is checked for stability (AutoRead).

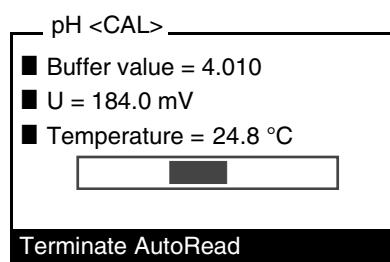

18	Wait for the end of the AutoRead measurement or <i>Terminate AutoRead</i> and accept the calibration value with <MENU/ENTER>. The new calibration values are displayed as a message (■). You have the following options: <ul style="list-style-type: none"> ● Accept the new calibration values with <MENU/ENTER>. Subsequently, the calibration record is displayed and output to the interface at the same time. ● To switch to the measured value display <u>without</u> accepting the new calibration values, press <M> or <ESC>.
----	---

4.4.7 Carrying out a ConCal calibration

Single-point calibration

Use any buffer solution for this rapid method.
The calibration will be the more exact the nearer the pH value of the buffer solution is to that of the test sample.

Two-point calibration

Use two buffer solutions for this procedure:

- first buffer solution: pH 7.0 ± 0.5
- any other buffer solution

For this calibration, *Calibration type ConCal* must be set in the sensor menu (see section 4.4.4).

1	In the measured value display, select the pH or mV measuring window with <▲> <▼> and <M>.
2	Start the calibration with <CAL>. The calibration display appears.

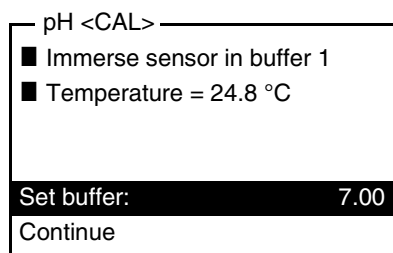

3	Thoroughly rinse the electrode with distilled water.
4	Immerse the electrode in buffer solution 1.
5	Set the nominal buffer value for the measured temperature with <MENU/ENTER> and <▲> <▼>. Then confirm the value with <MENU/ENTER>.
6	If the <i>Set temperature</i> menu item appears, measure and enter the temperature of the buffer manually (measurement without temperature sensor).
7	Select <i>Continue</i> with <▲> <▼> and press <MENU/ENTER>. The buffer is measured. The measured value is checked for stability (AutoRead).

pH <CAL>

- Buffer value = 6.80
- U = 12.0 mV
- Temperature = 24.8 °C

Terminate AutoRead

- 8 Wait for the end of the AutoRead measurement or *Terminate AutoRead* and accept the calibration value with <MENU/ENTER>. The calibration display for the next buffer appears.

pH <CAL>

- Immerse sensor in buffer 2
- Temperature = 24.8 °C

Exit with one point calibration

Set buffer: 8.27

Continue

- 9 For single-point calibration, select *Exit with one point calibration* with <▲> <▼> and confirm with <MENU/ENTER>. The calibration is completed as a single-point calibration. The new calibration values are displayed as a message (■). You have the following options:
- Accept the new calibration values with <MENU/ENTER>. Subsequently, the calibration record is displayed and output to the interface at the same time.
 - To switch to the measured value display without accepting the new calibration values, press <M> or <ESC>.



Note

For **single-point calibration**, the instrument uses the Nernst slope (-59.16 mV/pH at 25 °C) and determines the asymmetry of the electrode.

**Continuing for two-point
calibration
(*Calibration type
ConCal*)**

10	Thoroughly rinse the electrode with distilled water.
11	Immerse the electrode in buffer solution 2.
12	Set the nominal buffer value with <MENU/ENTER> and <▲> <▼> . Then confirm the value with <MENU/ENTER> .
13	If the <i>Set temperature</i> menu item appears, measure and enter the temperature of the buffer manually (measurement without temperature sensor).
14	Select <i>Continue</i> with <▲> <▼> and press <MENU/ENTER> . The buffer is measured. The measured value is checked for stability (AutoRead).

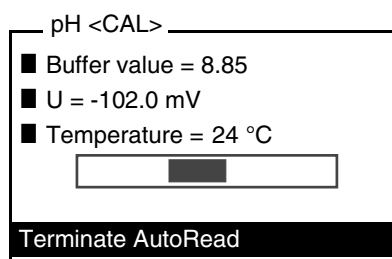

15	Wait for the end of the AutoRead measurement or <i>Terminate AutoRead</i> and accept the calibration value with <MENU/ENTER> . The new calibration values are displayed as a message (■). You have the following options: <ul style="list-style-type: none"> ● Accept the new calibration values with <MENU/ENTER>. Subsequently, the calibration record is displayed and output to the interface at the same time. ● To switch to the measured value display <u>without</u> accepting the new calibration values, press <M> or <ESC>.
----	--

4.5 Ion concentration

4.5.1 General information



Note

Incorrect calibration of ion sensitive electrodes will result in incorrect measured values. Calibrate regularly before measuring.



Caution

When connecting an earthed PC/printer, measurements cannot be performed in earthed media as incorrect values would result. The RS232 interface is not galvanically isolated.

Temperature measurement in ISE measurements

For reproducible measurements of the ion concentration, it is essential to measure the temperature of the test sample.

You have the following possibilities of measuring the temperature:

- Measurement of the temperature by the integrated temperature sensor of a simultaneously connected DO sensor or conductivity measuring cell in the test sample.
- Manual determination and input of the temperature.

The measuring instrument recognizes whether a suitable sensor is connected and automatically switches on the temperature measurement.

The display of the temperature indicates the active temperature measuring mode:

Temperature sensor, <i>Cond or Oxi</i>	Resolution of the temp. display	Mode
-	1 °C	Manual
yes	0.1 °C, <i>measured temperature value flashes</i>	The temperature value of the second sensor (Cond or Oxi) in the same test sample is taken over for measurement*

* If this is not required you can unplug the second sensor and enter the temperature manually.

Preparatory activities

Perform the following preparatory activities when you want to measure:

1	Connect the ISE combination electrode to the measuring instrument. The pH/ISE measuring window is displayed.
2	If necessary, select the ISE display (unit, mg/l) with <M>.
3	Measure the temperature of the test sample using a thermometer.
4	Calibrate or check the measuring instrument with the electrode.



Note

While no valid calibration is available, e.g. in the delivery condition, "Error" appears in the measured value display.

4.5.2 Measuring the ion concentration

1	Perform the preparatory activities according to section 4.5.1.
2	Immerse the electrode in the test sample.

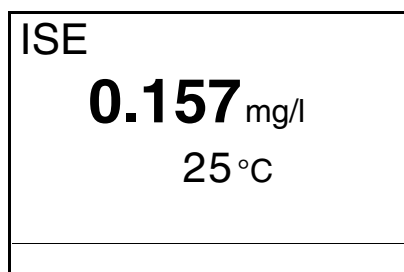

AutoRead (drift control)

The AutoRead function (drift control) continually checks the stability of the measurement signal. The stability has a considerable impact on the reproducibility of measured values. The display of the measured variable flashes until a stable measured value is available.

Criteria

With identical measurement conditions, the following applies:

Measuring signal	Reproducibility	Response time
Electrode voltage	better than 0.1 mV	> 30 seconds

Temperature while calibrating and measuring

For precise ISE measurements the temperature difference between measurement and calibration should not be greater than 2 K. Therefore,

adjust the temperature of the standard and measuring solutions accordingly. If the temperature difference is greater the *[TempErr]* warning appears in the measured value display.

4.5.3 Settings for ISE measurements

Overview The following settings are possible for ISE measurements:

- *Calibration record* (display)

Settings The settings are made in the measuring menu of the ISE measurement. To open the settings, activate the relevant measuring window in the measured value display and press the **<MENU/ENTER>** key shortly. After completing the settings, switch to the measured value display with **<M>**.

Menu item	Possible setting	Description
<i>Calibration / Calibration record</i>	-	Displays the calibration record of the last calibration.
<i>Man. temperature</i>	-20 ... +130 °C	Entry of the manually determined temperature. For measurements without temperature sensor only.

4.5.4 Calibrating for ISE measurements

Why calibrate? Ion-selective electrodes age and are temperature-dependent. This changes the slope. As a result, an inexact measured value is displayed. Calibration determines the current value of the slope of the electrode and stores it in the instrument.

Thus, you should calibrate before each measurement and at regular intervals.

- When to calibrate?**
- Before any measurement if possible
 - After connecting another ISE electrode
 - When the sensor symbol flashes, e.g. after a voltage interruption (empty batteries)

Standard solutions

Use two or three different standard solutions. For three-point calibration, the standard solutions have to be selected in either increasing or decreasing order.

Standard solution	Values [mg/l]
Std 1	0.01; 0.02; 0.05; 0.1; 0.2; 0.5; 1; 2; 5; 10; 20; 50; 100; 200; 500; 1000
Std 2	If Std 2 > Std 1, Std 3 must be > Std 2
Std 3	If Std 2 < Std 1, Std 3 must be < Std 2

The calibration line is calculated by linear regression.



Note

The measurement precision is also dependent on the selected standard solutions. Therefore, the selected standard solutions should cover the expected value range of the subsequent concentration measurement.

Temperature while calibrating and measuring

For precise ISE measurements the temperature difference between measurement and calibration should not be greater than 2 K. Therefore, adjust the temperature of the standard and measuring solutions accordingly. If the temperature difference is greater the [TempErr] warning appears in the measured value display.

ISE Cal

This is the conventional **two-point** or **three-point calibration procedure** that uses 2 or 3 freely selectable standard solutions. The concentration expected in the measurement determines the concentration of the calibration standards.

AutoRead

In calibration, the AutoRead function is automatically activated. The current AutoRead measurement can be terminated at any time (accepting the current value).

Calibration record

When finishing a calibration, the new calibration values are displayed as an informative message (■ symbol) first. Then you can decide whether you want to take over these values of the new calibration or whether you want to continue measuring with the old calibration data. After accepting the new calibration values the calibration record is displayed.

Display calibration data and output to interface

You can have the data of the last calibration displayed (see section 4.8.5). Subsequently, you can transmit the displayed calibration data to the interface, e. g. to a printer or PC, with the <PRT> key.

**Note**

The calibration record is automatically transmitted to the interface after calibrating.

Sample record:

```

03.11.03  07:14
CALIBRATION ISE
03.11.03  07:12:01
Multi 350i ser. no.  12345678
Standard 1           0.010 mg/l
Standard 2           0.020 mg/l
Voltage 1            0.0 mV      24.0 °C
Voltage 2            9.0 mV      24.0 °C
Slope                29.9 mV
Sensor               +++

```

Calibration evaluation

After calibrating, the measuring instrument automatically evaluates the calibration.

Display	Calibration record	Magnitude of the slope [mV]
	+++	50.0 ... 70.0 or 25.0 ... 35.0
<i>Error</i> Perform error elimination according to chapter 6 WHAT TO DO IF...	<i>Error</i>	< 50 or > 70 or < 25 or > 35

Preparatory activities

Perform the following preparatory activities when you want to calibrate:

1	Connect the ISE combination electrode to the measuring instrument. The pH/mV/ISE measuring window is displayed.
2	Keep the standard solutions ready.
3	Measure the temperature of the standard solutions using a thermometer.

Carrying out an ISE calibration

Proceed as follows to calibrate the instrument:

1	In the measured value display, select the ISE measuring window with <▲> <▼> and <M>.
2	Start the calibration with <CAL>. The calibration display appears.

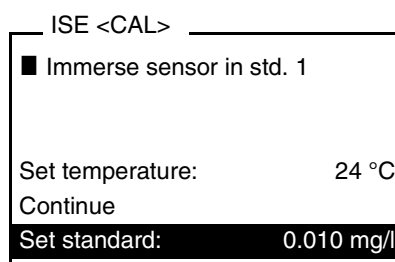

3	Thoroughly rinse the electrode with distilled water.
4	Immerse the electrode in standard solution 1.
5	Select the <i>Set standard</i> setting with <▲> <▼> and press <MENU/ENTER>.
6	Set the concentration of the standard solution with <▲> <▼> and press <MENU/ENTER>.
7	Measure the temperature of the standard solution using a thermometer.
8	Select the <i>Set temperature</i> setting with <▲> <▼> and press <MENU/ENTER>.
9	Set the temperature with <▲> <▼> and press <MENU/ENTER>.
10	Select <i>Continue</i> with <▲> <▼> and press <MENU/ENTER>. The standard solution is measured. The measured value is checked for stability (AutoRead).

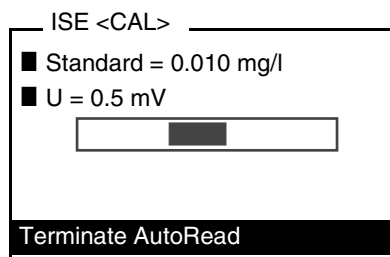

- | | |
|----|--|
| 11 | Wait for the end of the AutoRead measurement or accept the calibration value with <MENU/ENTER> .
The calibration display for the next standard solution appears. |
|----|--|

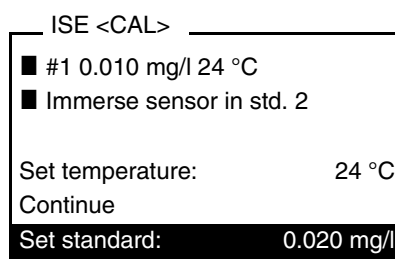

Continuing for two-point calibration

- | | |
|----|--|
| 12 | Thoroughly rinse the electrode with distilled water. |
| 13 | Immerse the electrode in standard solution 2. |
| 14 | Select the <i>Set standard</i> setting with <▲> <▼> and press <MENU/ENTER> . |
| 15 | Set the concentration of the standard solution with <▲> <▼> and press <MENU/ENTER> . |
| 16 | Measure the temperature of the standard solution using a thermometer. |
| 17 | Select the <i>Set temperature</i> setting with <▲> <▼> and press <MENU/ENTER> . |
| 18 | Set the temperature with <▲> <▼> and press <MENU/ENTER> . |
| 19 | Select <i>Continue</i> with <▲> <▼> and press <MENU/ENTER> .
The standard solution is measured.
The measured value is checked for stability (AutoRead). |

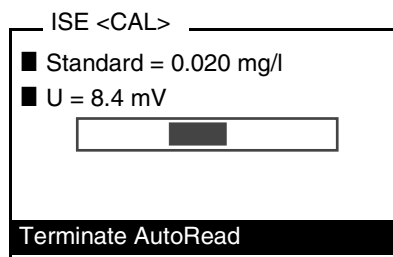

- 20 Wait for the end of the AutoRead measurement or accept the calibration value with <MENU/ENTER>. The calibration display for the next standard solution appears.

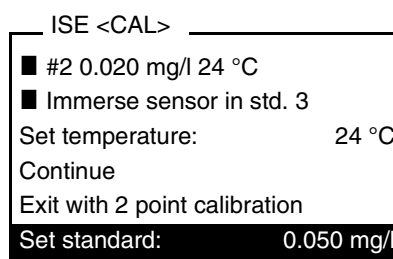

- 21 For two-point calibration, select *Exit with 2 point calibration* with <▲> <▼> and confirm with <MENU/ENTER>. The calibration is completed as a two-point calibration. The new calibration values are displayed as a message (■). You have the following options:
- Accept the new calibration values with <MENU/ENTER>. Subsequently, the calibration record is displayed and output to the interface at the same time.
 - To switch to the measured value display without accepting the new calibration values, press <M> or <ESC>.

Continuing for three-point calibration

Repeat the steps 12 to 20 in the same way for the third standard solution. After finishing the last calibration step, the new calibration values are displayed as a message (■).

You have the following options:

- Accept the new calibration values with <MENU/ENTER>. Subsequently, the calibration record is displayed and output to the interface at the same time.
- To switch to the measured value display without accepting the new calibration values, press <M> or <ESC>.

4.6 Dissolved oxygen

4.6.1 General information

You can measure the following variables:

- DO concentration
- DO saturation index ("DO saturation")
- DO partial pressure

DO measurements with the Multi 350i can be carried out using a Con-Ox, CelloX 325, DurOx 325 or StirrOx G DO sensor. The stirrer of the StirrOx G DO sensor has to be supplied with voltage separately using the NT/pH Mix 540 power supply. The measuring instrument automatically recognizes the type of the connected DO sensor.

The measuring instrument is supplied with the following functions:

- AutoRange (automatic switchover of the measurement range), If a measuring range is exceeded, AutoRange causes the measuring instrument to automatically change to the next higher measuring range and back again. Therefore, the instrument always measures in the measuring range with the highest possible resolution.
- The AutoRead function (drift control) for checking the stability of the measurement signal. This ensures the reproducibility of the measuring signal. The display of the measured variable flashes until a stable measured value is available.



Note

Incorrect calibration of DO sensors will result in incorrect measured values.

Calibrate at regular intervals.



Caution

When connecting an earthed PC/printer, measurements cannot be performed in earthed media as incorrect values would result. The RS232 interface is not galvanically isolated.

Temperature sensor

The DO sensor has an integrated temperature sensor that always measures the current temperature of the test sample.

Preparatory activities

Perform the following preparatory activities when you want to measure:

1	Connect the DO sensor to the measuring instrument. The DO measuring window is displayed.
2	Calibrate or check the measuring instrument with the sensor.

4.6.2 Measuring

1	Perform the preparatory activities according to section 4.6.1.
2	Immerse the DO sensor in the test sample.

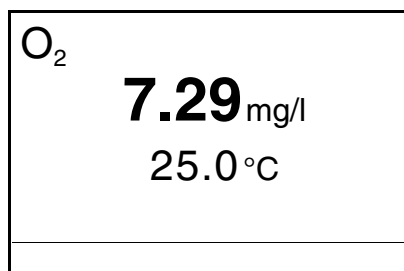
**Selecting the displayed measured variable**

You can switch between the following displays with **<M>**:

- DO concentration [mg/l]
- DO saturation [%]
- DO partial pressure [mbar].

Salinity correction

When measuring the concentration of solutions with a salt content of more than 1 g/l, a salinity correction is required. For this, you have to measure and input the salinity of the measured medium first. When the salinity correction is switched on, the **[SAL]** indicator is displayed in the measuring window.

**Note**

The salinity correction is switched on or off and the salinity is entered in the measuring menu of the DO measurement (see section 4.6.3).

**Note**

The ConOx double sensor can perform the salinity correction automatically. The conductivity module of the sensor measures the salt content of the test sample simultaneously with the DO. The measuring instrument takes the measured value into account.

**AutoRead
(drift control)**

The AutoRead function (drift control) continually checks the stability of the measurement signal. The stability has a considerable impact on the reproducibility of measured values. The display of the measured variable flashes until a stable measured value is available.

Criteria

With identical measurement conditions, the following applies:

Measuring mode	Reproducibility	Response time
DO concentration	better than 0.05 mg/l	> 10 seconds
DO saturation index	better than 0.6 %	> 10 seconds
DO partial pressure	Better than 1.2 mbar	> 10 seconds

4.6.3 Settings for DO sensors**Overview**

The following settings are possible for DO sensors:

- Salinity correction
- Salinity (salinity equivalent)
- Calibration interval
- Comparison measurement

Settings

The settings are made in the measuring menu of the DO measurement. To open the settings, activate the relevant measuring window in the measured value display and press the **<MENU/ENTER>** key shortly. After completing the settings, switch to the measured value display with **<M>**.

Menu item	Possible setting	Description
<i>Calibration / Calibration interval</i>	1 ... 999 d	<i>Calibration interval</i> for the DO sensor (in days). The measuring instrument reminds you to calibrate regularly by the flashing sensor symbol in the measuring window.
<i>Calibration / Comparison meas.</i>	<i>On</i> <i>Off</i>	Enables to adjust the measured value with the aid of a comparison measurement, e.g. Winkler titration. For details, see section 4.6.4.
<i>Calibration / Calibration record</i>	-	Displays the calibration record of the last calibration.
<i>Reset</i>	-	Resets all sensor settings to the delivery condition (see section 4.10.1).
<i>Sal automatic</i>	<i>On</i> <i>Off</i>	Automatic salt content correction for concentration measurements. Note: This function is available with the ConOx double sensor <u>only</u> .
<i>Sal correction</i>	<i>On</i> <i>Off</i>	Manual salt content correction for concentration measurements.
<i>Salinity</i>	0.0 ... 70.0	Salinity or salinity equivalent for the salt content correction. This function is only available if the manual salt content correction is switched on.

4.6.4 DO calibration

Why calibrate?

DO sensors age. This changes the slope of the DO sensor. Calibration determines the current slope of the sensor and stores this value in the instrument.

When to calibrate?

- After connecting another DO sensor
- When the sensor symbol flashes (after the calibration interval has expired).

Calibration datasets

The Multi 350i administrates three sets of calibration data:

- Set 1 for the type, "CellOx": – CellOx 325, or
– StirrOx G
- Set 2 for the type, "DurOx": – DurOx 325
- Set 3 for the type, "ConOx": – ConOx

Sensors of different types can be calibrated separately from each other. When a sensor of one type is calibrated, the calibration data of the other types remain stored. The Multi 350i recognizes the type of the connected sensor and automatically uses the correct calibration data.

Calibration procedure

The Multi 350i provides 2 calibration procedures:

- Calibration in water vapor-saturated air.
Use an OxiCal[®] air calibration vessel for the calibration.
- Calibration via a comparison measurement (e.g. Winkler titration according to DIN EN 25813 or ISO 5813). At the same time, the relative slope is adapted to the comparison measurement by a correction factor. When the correction factor is active, the *[Factor]* indicator appears in the measuring window.

AutoRead

The calibration procedure automatically activates the *AutoRead* function.

Display calibration data and output to interface

You can have the data of the last calibration displayed (see section 4.8.5). Subsequently, you can transmit the displayed calibration data to the interface, e. g. to a printer or PC, with the <PRT> key.



Note

The calibration record is automatically transmitted to the interface after calibrating.



Sample record:

```

03.11.03  07:14
CALIBRATION ConOx
03.11.03  07:12:58
Multi 350i ser. no. 12345678
Cal. interval      14 d
Relative slope     0.97
Sensor             +++
    
```

Calibration evaluation

After the calibration, the measuring instrument evaluates the current status of the sensor against the relative slope. The evaluation appears on the display and in the calibration record. The relative slope has no effect on the measuring accuracy. Low values indicate that the electrolyte will soon be depleted and the sensor will have to be regenerated.

Display	Calibration record	Relative slope
	+++	S = 0.8 ... 1.25
	++	S = 0.7 ... 0.8
	+	S = 0.6 ... 0.7
<i>Error</i>	<i>Error</i>	S < 0.6 or S > 1.25
Perform error elimination according to chapter 6 WHAT TO DO IF...		

**Calibration in
water vapor
saturated air
(air calibration vessel)**



For this calibration procedure, the *Comparison meas.* setting must be set to *Off* in the measuring menu.

Proceed as follows to calibrate the instrument:

Note

The sponge in the air calibration vessel must be moist (not wet). Leave the sensor in the air calibration vessel for a time long enough to adjust.

1	Put the DO sensor into the air calibration vessel.
2	Connect the DO sensor to the measuring instrument.
3	In the measured value display, select the DO measuring window with <▲> <▼> and <M>.
4	Start the calibration with <CAL>. The calibration display for the relevant sensor type appears.

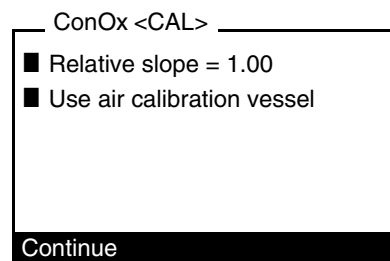

5	Put the DO sensor into the air calibration vessel.
6	Press <MENU/ENTER>. The AutoRead measurement to determine the relative slope starts.

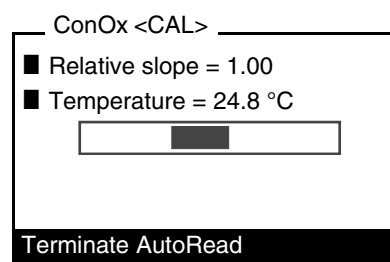

7	Wait for the end of the AutoRead measurement or accept the calibration value with <MENU/ENTER>. The determined relative slope is displayed as a message (■).
---	--

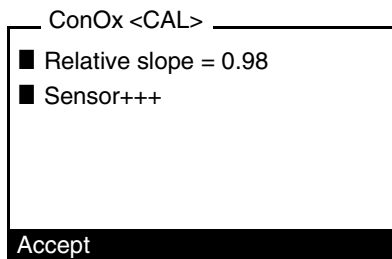

- 8 You have the following options:
- Accept the new calibration values with **<MENU/ENTER>**. Subsequently, the calibration record is displayed and output to the interface at the same time.
 - To switch to the measured value display without accepting the new calibration values, press **<M>** or **<ESC>**.

Calibration via a Comparison meas.

For this calibration procedure, the *Comparison meas.* setting must be set to *On* in the measuring menu.



Note

Before calibrating via a comparison measurement, the sensor should be calibrated in the air calibration vessel.

Proceed as follows to calibrate the instrument:

- | | |
|---|---|
| 1 | Connect the DO sensor to the measuring instrument. |
| 2 | Immerse the DO sensor in the reference solution. |
| 3 | In the measured value display, select the DO measuring window with <▲> <▼> and <M> . |
| 4 | Start the calibration with <CAL> . The calibration display appears. |

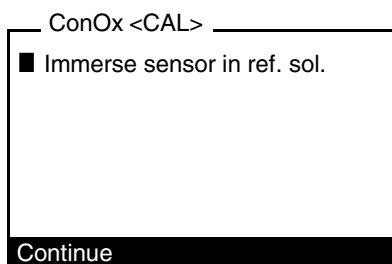

- 5 Press **<MENU/ENTER>**.
The AutoRead measurement to determine the DO concentration starts.

ConOx <CAL> _____

■ Concentration = 8.5 mg/l
■ Temperature = 24.8 °C

Terminate AutoRead

- 6 Wait for the end of the AutoRead measurement or accept the measured value with **<MENU/ENTER>**.
The determined DO content is displayed as a message (■).

ConOx <CAL> _____

■ Concentration = 8.49 mg/l
■ Temperature = 24.8 °C

Set factor: 1.000

Accept

- 7 Press **<MENU/ENTER>**.

- 8 Using **<▲>** **<▼>**, set the correction factor to adjust the displayed concentration value to the nominal value (value of the comparison measurement). Subsequently, accept the correction factor with **<MENU/ENTER>**.

- 9 Select *Accept* with **<▲>** **<▼>** and press **<MENU/ENTER>**.
The measuring instrument switches to the measured value display. The *[Factor]* indicator appears in the measuring window.

4.7 Conductivity

4.7.1 General information

You can measure the following variables:

- Conductivity
- Specific resistance
- Salinity
- Total dissolved solids (TDS)

The measuring instrument is supplied with the following functions:

- AutoRange (automatic switchover of the measurement range). If a measuring range is exceeded, AutoRange causes the measuring instrument to automatically change to the next higher measuring range and back again. Therefore, the instrument always measures in the measuring range with the highest possible resolution.
- AutoRead drift control) for checking the stability of the measurement signal. This ensures the reproducibility of the measuring signal. The display of the measured variable flashes until a stable measured value is available.

Temperature measurement



The TetraCon 325, ConOx, LR 325/01 and LR 325/001 conductivity measuring cells have an integrated temperature sensor.

Caution

When connecting an earthed PC/printer, measurements cannot be performed in earthed media as incorrect values would result. The RS232 interface is not galvanically isolated.

Preparatory activities

Perform the following preparatory activities when you want to measure:

1	Connect a conductivity measuring cell to the measuring instrument. The conductivity measuring window is displayed.
2	Check whether the <i>Measuring cell</i> and cell constant settings are suitable for the connected conductivity measuring cell. If necessary, correct the settings.



Note

The selection of the measuring cell and setting of the cell constant is made in the conductivity measuring menu (see section 4.7.4). The cell constant to be set must either be taken from the operating manual of the measuring cell or is printed on the measuring cell.

4.7.2 Measuring

You can carry out conductivity measurements as follows:

1	Perform the preparatory activities according to section 4.7.1.
2	Immerse the conductivity measuring cell in the test sample.

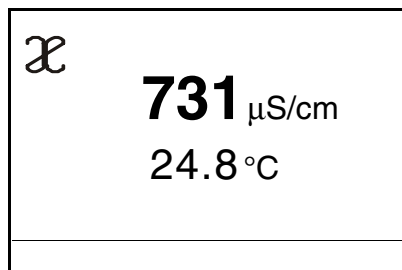

Selecting the displayed measured variable

You can switch between the following displays with **<M>**:

- Conductivity [$\mu\text{S}/\text{cm}$] / [mS/cm]
- Specific resistance [$\text{k}\Omega\text{-cm}$] / [$\text{M}\Omega\text{-cm}$]
- Salinity SaL []
- Total dissolved solids TDS [mg/l]

The factor to calculate the total dissolved solids is set to 1.00 in the factory. You can adjust this factor to meet your requirements in the range of 0.40 to 1.00. The factor can be set in the TDS measuring menu.

AutoRead criterion

The measuring instrument checks the stability of the measured value on the basis of the temperature measurement. For identical measurement conditions, the following applies:

Measured variable	Reproducibility	Response time
Temperature	better than 0.02 °C	> 10 seconds

4.7.3 Temperature compensation

The calculation of the temperature compensation is based on the pre-set reference temperature, 20 °C or 25 °C. It appears on the display as *Tr20* or *Tr25*.

You can select one of the following temperature compensation methods:

- **Nonlinear temperature compensation (*nLF*)**
according to EN 27 888
- **Linear temperature compensation (*Lin*)**
with selectable coefficients of 0.000 ... 3.000 %/K
- **No temperature compensation (off)**



Note

The reference temperature and temperature compensation are set in the conductivity measuring menu (see section 4.7.4).

Application tips

Select the following temperature compensations given in the table according to the respective test sample:

Test sample	Temperature compensation	Display indicator
Natural water (ground water, surface water, drinking water)	<i>nLF</i> according to EN 27 888	<i>nLF</i>
Ultrapure water	<i>nLF</i> according to EN 27 888	<i>nLF</i>
Other aqueous solutions	<i>lin</i> Set linear temperature coefficient 0.001 ... 3.000 %/K	<i>lin</i>
Salinity (seawater)	Automatic <i>nLF</i> according to IOT	<i>Sal, nLF</i>

4.7.4 Settings for conductivity measuring cells

Overview The following settings are possible for conductivity measuring cells:

- Measured variable
- Reference temperature
- Temperature compensation
- TDS factor
- Calibration interval
- Measuring cell/cell constant

Settings The settings are made in the measuring menu of the conductivity measurement. To open the settings, activate the relevant measuring window in the measured value display and press the **<MENU/ENTER>** key shortly. After completing the settings, switch to the measured value display with **<M>**.

Menu item	Possible setting	Description
<i>Calibration / Calibration interval</i>	1 ... 999 d	<i>Calibration interval</i> for the measuring cell (in days). The measuring instrument reminds you to calibrate regularly by the flashing sensor symbol in the measuring window.
<i>Calibration / Calibration record</i>	-	Displays the calibration record of the last calibration.
<i>Reset</i>	-	Resets all sensor settings to the delivery condition (see section 4.10.1).
<i>Temp. comp. (TC) / Reference temp.</i>	20 °C 25 °C	Reference temperature This setting is only available when the <i>Conductivity</i> or <i>Spec. resist.</i> display is set.
<i>Temp. comp. (TC) / Compensation</i>	nLF lin Off	Procedure for temperature compensation (see section 4.7.3). This setting is only available when the <i>Conductivity</i> or <i>Spec. resist.</i> display is set.

Menu item	Possible setting	Description
<i>Temp. comp. (TC) / Linear coeff.</i>	0.000 ... 3.000 %/K	Coefficient of the linear temperature compensation. This setting is only available when the linear temperature compensation is set.
<i>Measuring cell</i>	<p><i>Cal</i></p> <p><i>LR325/001</i></p> <p><i>LR325/01</i></p> <p><i>man</i></p>	<p><i>Measuring cell used</i></p> <p>Measuring cells the cell constant of which is determined by calibration in the KCL control standard solution. Calibration ranges: 0.450 to 0.500 cm⁻¹ and 0.800 to 1.200 cm⁻¹ The currently valid cell constant is displayed in the status line.</p> <p><i>LR 325/001</i> measuring cell, nominal cell constant 0.010 cm⁻¹. The cell constant is permanently set.</p> <p><i>LR 325/01</i> measuring cell, nominal cell constant 0.100 cm⁻¹. The cell constant can be adjusted in the range from 0.090 to 0.110 cm⁻¹.</p> <p>Any measuring cells with freely adjustable cell constants in the range from 0.250 to 25.000 cm⁻¹.</p>
<i>Cell constant</i>	0.090 to 0.110 cm ⁻¹	Display and setting option of the cell constant of the <i>LR 325/01</i> measuring cell.
<i>Man. cell const.</i>	0.250 to 25.000 cm ⁻¹	Display and setting option of the cell constant of any measuring cells (<i>man</i>).

4.7.5 Determining the cell constant (calibration in the control standard)

Why determine the cell constant?

Aging slightly changes the cell constant, e. g. by coatings. As a result, an inexact measured value is displayed. The original characteristics of the cell can often be restored by cleaning the cell. Calibration determines the current value of the cell constant and stores this value in the instrument.

Thus, you should calibrate at regular intervals (we recommend: every 6 months).

Procedure

You can determine the actual cell constant of the conductivity measuring cell by calibrating with the control standard in the following ranges:

- 0.450 ... 0.500 cm⁻¹
(e.g. TetraCon 325, nominal cell constant 0.475)
- 0.800 ... 1.200 cm⁻¹
(cells with a cell constant of approx. 1)

The cell constant is determined in the control standard, 0.01 mol/l KCl. Cell constants outside the ranges quoted above cannot be calibrated.

In the delivery condition, the calibrated cell constant of the measuring instruments is set to 0.475 cm⁻¹ (conductivity measuring cells, TetraCon 325 and ConOx).

AutoRead

The calibration procedure automatically activates the *AutoRead* function.

Display calibration data and output to interface

You can have the data of the last calibration displayed (see section 4.8.5). Subsequently, you can transmit the displayed calibration data to the interface, e. g. to a printer or PC, with the <PRT> key.



Note

The calibration record is automatically transmitted to the interface after calibrating.

Sample record:

```

3.11.03  07:14
CALIBRATION Cond
03.11.03  07:13:22
Multi 350i ser. no.  12345678
Cal. interval        14 d
Cell constant        0.975 1/cm      25.0 °C
Sensor               +++

```

Calibration evaluation

After the calibration, the measuring instrument automatically evaluates the current status of the calibration. The evaluation appears on the display and in the calibration record.

Display	Calibration record	Cell constant [cm ⁻¹]
	+++	within the ranges 0.450 ... 0.500 cm ⁻¹ or 0.800 ... 1.200 cm ⁻¹
<i>Error</i> Perform error elimination according to chapter 6 WHAT TO DO IF...	<i>Error</i>	outside the ranges 0.450 ... 0.500 cm ⁻¹ or 0.800 ... 1.200 cm ⁻¹

Determining the cell constant

For this calibration procedure, the *Measuring cell* setting must be set to *cal* in the measuring menu. Proceed as follows to determine the cell constant:

- 1 | Connect a conductivity measuring cell to the measuring instrument.
- 2 | In the measured value display, select the conductivity measuring window with <▲> <▼> and <M>.
- 3 | Start the calibration with <CAL>. The calibration display appears.

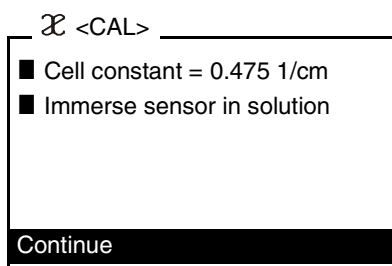

- 4 | Immerse the conductivity measuring cell in the control standard solution, 0.01 mol/l KCl.

- 5 Press **<MENU/ENTER>**.
The AutoRead measurement to determine the cell constant starts.

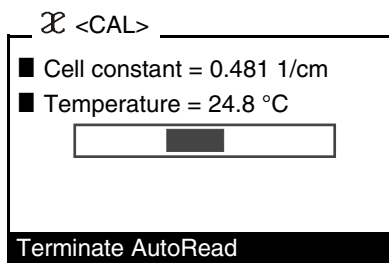

- 6 Wait for the end of the AutoRead measurement or accept the calibration value with **<MENU/ENTER>**.
The determined cell constant is displayed as a message (■).

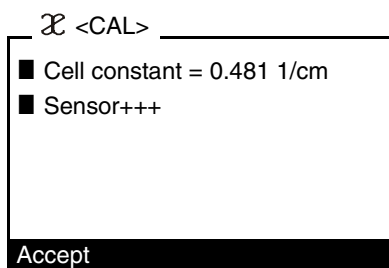

- 7 You have the following options:
- Accept the new calibration values with **<MENU/ENTER>**. Subsequently, the calibration record is displayed and output to the interface at the same time.
 - To switch to the measured value display without accepting the new calibration values, press **<M>** or **<ESC>**.

4.8 Data storage

You can transmit measured values (data records) to the data storage in two ways:

- Manual data storage (see section 4.8.1)
- Automatic data storage at intervals (see section 4.8.2)

Each storage process transmits the current dataset to the interface at the same time.

Measurement dataset

A complete dataset consists of:

- Date/time
- Instrument designation with series number
- ID number
- Measured values of the connected sensors
- Temperature values of the sensors connected
- AutoRead info: *AR* appears with the measured value if the Auto-Read criterion was met while storing (stable measured value). Otherwise, the *AR* display is missing.
- Measurement conditions (salt content correction, cell constant, reference temperature, temperature compensation, TDS factor).

Storage locations

The measuring instrument has separate data storages for manually stored measured values and automatically stored measured values.

Storage	Maximum number of datasets
Manual data storage	504
Automatic data storage	1800

4.8.1 Manual data storage

Proceed as follows to transmit to the data data storage and simultaneously output to the interface a measurement dataset:

- 1 Press the <STO> key shortly.
The menu for manual data storage appears.

```

_<STO> 1 of 504
- 30.10.2003 11:24:16
- pH 7.000 24.8 °C AR
- Oxi 7.27 mg/l 25.0 °C AR
- TDS 689 mg/l 25.0 °C AR
Store with ID no.:      1
Continue
  
```

- 2 If necessary, change and confirm the ID number (1 ... 999) with <▲> <▼> and <MENU/ENTER>.
The dataset is stored. The instrument switches to the measured value display.

If the data storage is full

The following window appears if all 504 storage locations are occupied:

```

Warning
Data storage full. Erase?
Yes
No
  
```

You have the following options:

- To erase the entire data storage, confirm *Yes*.
- To cancel the data storage process and switch to the measured value display, confirm *No*. Then you can, e.g. transmit the stored data to a PC (see section 4.8.3) and subsequently erase the data storage (see section 4.8.4).

4.8.2 Automatic data storage at intervals

The storage interval (*Interval*) determines the chronological interval between automatic storage processes. Each storage process transmits the current dataset to the interface at the same time.

Configuring the automatic data storage function

- 1 Press the <STO> key for a long time.
The menu for automatic data storage appears.

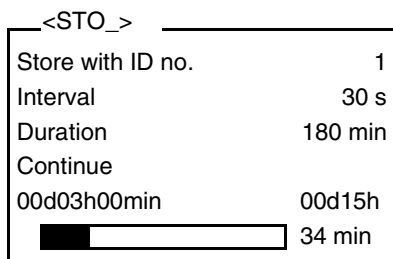

Settings

You can configure the automatic data storage function with the following settings:

Menu item	Possible setting	Description
<i>Store with ID no.</i>	1 ... 999	ID number for the dataset series.
<i>Interval</i>	5 s, 10 s, 30 s, 1 min, 5 min, 10 min, 15 min, 30 min, 60 min	Storage interval. The lower limit of the storage interval can be restricted by the number of free storage locations. The upper limit is restricted by the storage duration.
<i>Duration</i>	1 min ... x min	Storage duration Specifies after which time the automatic data storage should be terminated. The lower limit of the storage duration is restricted by the storage interval. The upper limit is restricted by the number of free storage locations.

Data storage administration

The two lower display lines indicate the use of the data storage calculated in advance for the selected settings:

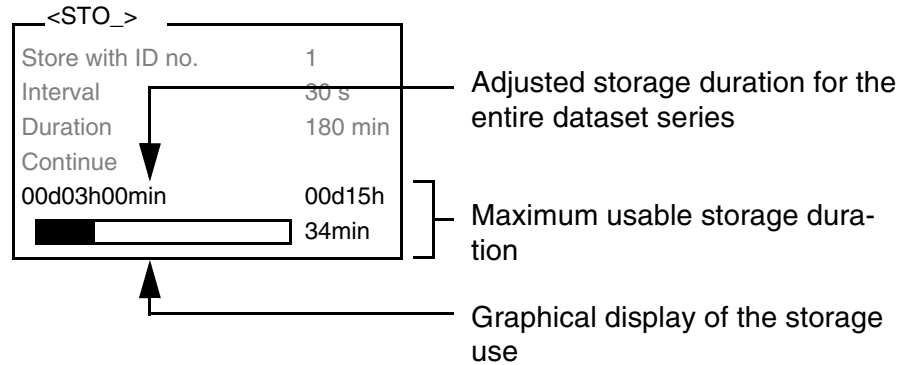

Starting the automatic data storage function

To start the automatic data storage function, select *Continue* with $\langle \blacktriangle \rangle$ $\langle \blacktriangledown \rangle$ and confirm with $\langle \text{MENU/ENTER} \rangle$. The measuring instrument switches to the measured value display.

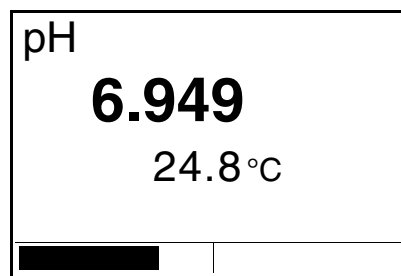

The active automatic data storage function can be recognized from the progress bar in the status line. The progress bar indicates how much of the adjusted storage duration has already expired.



Note

The automatic data storage function is interrupted if you start other functions, e.g. output the data storage. After the other function has been finished, the automatic data storage function is continued. Note that this causes chronological gaps in the dataset series.

Terminating the automatic data storage function prematurely

Proceed as follows to switch off the automatic data storage function before the adjusted storage duration has expired:

- 1 Press the **<STO>** key for a long time.
The following window appears.

Warning

Stop automatic storage?

Yes

No

- 2 Select and confirm *Yes* with **<▲>** **<▼>** and **<MENU/ENTER>**.
The measuring instrument switches to the measured value display.
The automatic data storage function is terminated.

4.8.3 Editing the measured value storage

You can select the contents of the manual or automatic measured value storage by means of different filter criteria and

- read them out on the display, and
- output them to the interface.

Each measured value storage has a separate erasure function for the entire contents, independent of the filter settings.

Editing the data storage

The storage can be edited in the system menu, submenu *Data storage*. To open the system menu in the measured value display, press the **<MENU/ENTER>** key for approx. 1 s.



Note

The settings are explained here using the manual data storage as an example. The same settings and functions are available for the automatic data storage.

Settings	Menu item	Setting/ function	Description
	<i>Data storage / Manual data storage / Display</i>	-	<p>Displays in pages all measuring datasets that correspond to the filter settings.</p> <p><u>Further options:</u></p> <ul style="list-style-type: none"> ● Scroll through the datasets with <▲> <▼>. ● Output the displayed dataset to the interface with <PRT>. ● Quit the display with <ESC>.
	<i>Data storage / Manual data storage / Output to RS232</i>	-	<p>Outputs to the interface all measuring datasets that correspond to the filter settings. The output takes place in ascending order of the ID number. The process can take several minutes. To terminate the process prematurely, press <ESC>.</p>
	<i>Data storage / Manual data storage / Data filter</i>	-> see explanations below this table	<p>Allows to set certain filter criteria in order to display and output them to the interface datasets.</p>
	<i>Data storage / Manual data storage / Erase</i>	-	<p>Erases the entire contents of the selected measuring data storage, independent of the filter settings.</p> <p><u>Note:</u> All calibration data remains stored when performing this action.</p>

Data filter	Menu item	Setting/ function	Description
	<i>Filter</i>	<i>No filter</i>	Filter criteria: Data filter switched off
		<i>Date & ID number</i>	Selection according to pe- riod and ID number
		<i>ID number</i>	Selection according to ID number
		<i>Date</i>	Selection according to pe- riod
	<i>From</i>	<i>TT.MM.JJ</i>	Selects all datasets within the specified period.
	<i>Until</i>	<i>TT.MM.JJ</i>	
	<i>With ID</i>	0 ... 999	Selects all datasets with the specified ID number.

Display presentation of a dataset

```

30.10.2003 11:24:16 (1)
ID number 1
- pH 7.000 24.8 °C AR
- Oxi 7.27 mg/l 25.0 °C AR
- TDS 689 mg/l 25.0 °C AR

```

Sample printout

```
3.11.03 15:48:08
Multi 350i ser. no. 12345678
ID number: 1
ISE 0.316 mg/l 22 °C , AR
Oxi 6.32 mg/l 24.8 °C , AR
Sal = 0.7
Cond 1413 uS/cm 24.8 °C
C = 0.975 1/cm, Tref25, Lin, TC = 2.000 %/K

-----

03.11.03 09:56:20
Multi 350i ser. no. 12345678
ID number: 1
pH 6.12 24.8 °C , AR
Oxi 7.46 mg/l 24.8 °C
Sal = 0.0
Res 69.0 kOhm*cm 24.8 °C , AR
C = 0.010 1/cm, Tref25, Lin, TC = 2.000 %/K

-----

03.11.03 09:27:24
Multi 350i ser. no. 12345678
ID number: 1
pH 7.13 24.8 °C Cond-TP, AR
Oxi 5.95 mg/l 24.8 °C , AR
Sal = 0.7
Res 0.708 kOhm*cm 24.8 °C , AR
C = 0.975 1/cm, Tref25, Lin, TC = 2.000 %/K

-----

etc...
```

Quitting the display

To quit the display of stored measuring datasets, you have the following options:

- Switch directly to the measured value display with **<M>**.
- Quit the display and move to the next higher menu level with **<ESC>** or **<MENU/ENTER>**.

4.8.4 Erasing the measured value storage

How to erase the measured value storage is described in section 4.8.3 EDITING THE MEASURED VALUE STORAGE.

4.8.5 Displaying and outputting calibration records

You can display the calibration data

- of one selected sensor, or
- of all sensors connected

and then output them to the interface.

Displaying the calibration record of a selected sensor

The calibration record of the last calibration can be found under the *Calibration / Calibration record* menu item in the respective measuring menu. To open the settings, activate the relevant measuring window in the measured value display and press the **<MENU/ENTER>** key shortly.

Displaying the calibration records of all sensors connected

The calibration records of the last calibration can be found under the *Data storage / Calibration data storage* menu item in the system menu. To open the system menu in the measured value display, press the **<MENU/ENTER>** key for approx. 1 s.

Menu item	Setting/function	Description
<i>Data storage / Calibration data storage / Display</i>	-	<p>Displays in pages all calibration records of all sensors.</p> <p><u>Further options:</u></p> <ul style="list-style-type: none"> ● Scroll through the calibration records with <▲> <▼>. ● Output the displayed calibration record to the interface with <PRT>. ● Quit the display with <ESC> or <MENU/ENTER>. ● Switch directly to the measured value display with <M>.
<i>Data storage / Calibration data storage / Output to RS232</i>	-	Outputs to the interface the calibration records of all sensors.

Sample printout

```
03.11.03 07:14
CALIBRATION pH
03.11.03 07:10:45
Multi 350i ser. no. 12345678
Cal. interval      7 d
AutoCal TEC
Buffer 1           4.01
Buffer 2           7.00
Buffer 3           10.01
Voltage 1          184.0 mV      24.0 °C
Voltage 2           0.0 mV      24.0 °C
Voltage 3          -177.0 mV      24.0 °C
Slope              -60.2 mV/pH
Asymmetry          3.0 mV
Sensor             +++
03.11.03 07:14
CALIBRATION ISE
03.11.03 07:12:01
Multi 350i ser. no. 12345678
Standard 1         0.010 mg/l
Standard 2         0.020 mg/l
Voltage 1          0.0 mV      24.0 °C
Voltage 2           9.0 mV      24.0 °C
Slope              29.9 mV
Sensor             +++
etc...
```

4.9 Transmitting data (RS 232 interface)

4.9.1 Options for data transmission

Via the RS 232 interface, you can transmit data to a PC or an external printer. The following table shows which data are transmitted to the interface in which way:

Data	Control	Operation / description
Current measured values of all connected sensors	Manual	<ul style="list-style-type: none"> ● By pressing <PRT> shortly. ● Simultaneously with every manual data storage process (see section 4.8.1).
	Automatic, at intervals	<ul style="list-style-type: none"> ● By pressing <PRT> for a long time. Then you can set the transmission interval. ● Simultaneously with every automatic data storage process (see section 4.8.2).
Stored measured values	Manual	<ul style="list-style-type: none"> ● Displayed dataset with <PRT> after calling up from the data storage. ● All datasets according to the filter criteria via the <i>Output to RS232</i> function. <p>For details, see section 4.8.3.</p>
Calibration records	Manual	<ul style="list-style-type: none"> ● Calibration record of a sensor with <PRT> (after calling up from the data storage or at the end of a calibration). ● All calibration records after calling up from the data storage via the <i>Output to RS232</i> function. <p>For details, see section 4.8.5</p>
	Automatic	<ul style="list-style-type: none"> ● For the respective sensor at the end of a calibration.



Note

The following rule applies: With the exception of the menus, shortly pressing the <PRT> key generally outputs the display contents to the

interface (displayed measured values, measuring datasets, calibration records).

4.9.2 Connecting a PC/external printer

Use the AK340/B (PC) or AK325/S (ext. printer) cable to connect the interface to the devices.



Caution

The RS232 interface is not galvanically isolated. When connecting an earthed PC/printer, measurements cannot be performed in earthed media as incorrect values would result.

Set up the following transmission data on the PC/printer:

Baud rate	selectable between: 1200, 2400, 4800, 9600, 19200
Handshake	RTS/CTS
PC only:	
Parity	none
Data bits	8
Stop bits	2

Socket assignment

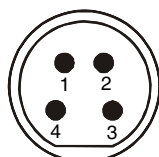

RS 232
REC

- 1 CTS
- 2 RxD
- 3 Ground
- 4 TxD

4.9.3 Operation with MultiLab pilot

With the aid of the MultiLab pilot software, you can record and evaluate measuring data with a PC. The data is transmitted after the measuring instrument is connected to the RS232 serial interface (COM interface) of a PC.



Note

More detailed information can be found in the MultiLab pilot operating manual.

4.10 Reset

You can reset (initialize) all sensor settings and sensor-independent settings separately from each other.

4.10.1 Resetting the sensor settings



Note

The calibration data are reset to the default settings together with the measuring parameters. Recalibrate after performing a reset.

pH

The following settings for pH measurements are reset to the default settings with the *Reset* function:

Setting	Default settings
<i>Calibration type</i>	<i>TEC</i>
<i>Cal. interval</i>	7 d
<i>Unit for slope</i>	mV/pH
Measured variable	pH
<i>High resolution</i>	<i>On</i>
Asymmetry	0 mV
Slope	-59.16 mV
Temperature, manual	25 °C

Oxi

The following settings for DO measurements are reset to the default settings with the *Reset* function:

Setting	Default settings
<i>Cal. interval</i>	14 d
<i>Comparison meas.</i>	<i>Off</i>
Measured variable	DO concentration
Relative slope (S_{Rel})	1.00
Salinity (value)	0.0
Salinity (function)	Off

Cond The following settings for conductivity measurements are reset to the default settings with the *Reset* function:

Setting	Default settings
<i>Cal. interval</i>	150 d
Measured variable	∅
Cell constant (c)	0.475 cm ⁻¹ (calibrated) 0.475 cm ⁻¹ (set up)
Temperature compensation	nLF
Reference temperature	25 °C
Temperature coefficient (TC) of the linear temperature compensation	2.000 %/K
TDS factor	1.00

The sensor settings are reset under the *Reset* menu item in the respective measuring menu. To open the settings, activate the relevant measuring window in the measured value display and press the **<MENU/ENTER>** key shortly.

4.10.2 Resetting the system settings

The following system settings can be reset to the delivery status:

Setting	Default settings
<i>Language</i>	<i>English</i>
<i>Temperature unit</i>	°C
<i>Beep</i>	<i>On</i>
<i>Baud rate</i>	4800 Baud
<i>Output format</i>	ASCII
<i>Contrast</i>	48 %
<i>Illumination</i>	<i>On</i>
<i>Switchoff time</i>	30 min

The system settings are reset under the *System / Reset* menu item in the system menu. To open the system menu in the measured value display, press the **<MENU/ENTER>** key for approx. 1 s.

5 Maintenance, cleaning, disposal

5.1 Maintenance

The measuring instrument is maintenance-free.

5.2 Cleaning

Occasionally wipe the outside of the measuring instrument with a damp, lint-free cloth. Disinfect the housing with isopropanol as required.



Caution

The housing components are made out of synthetic materials (polyurethane, ABS and PMMA). Thus, avoid contact with acetone and similar detergents that contain solvents. Remove any splashes immediately.

5.3 Disposal

Packing

This measuring instrument is sent out in a protective transport packing. We recommend: Keep the packing material. The original packing protects the measuring instrument from transport damages.

Rechargeable batteries



NiMH

Remove the rechargeable battery from the instrument and dispose of it at a suitable facility according to local legal requirements. It is illegal to dispose of the rechargeable batteries with household refuse. Proceed as follows to disassemble the rechargeable batteries:

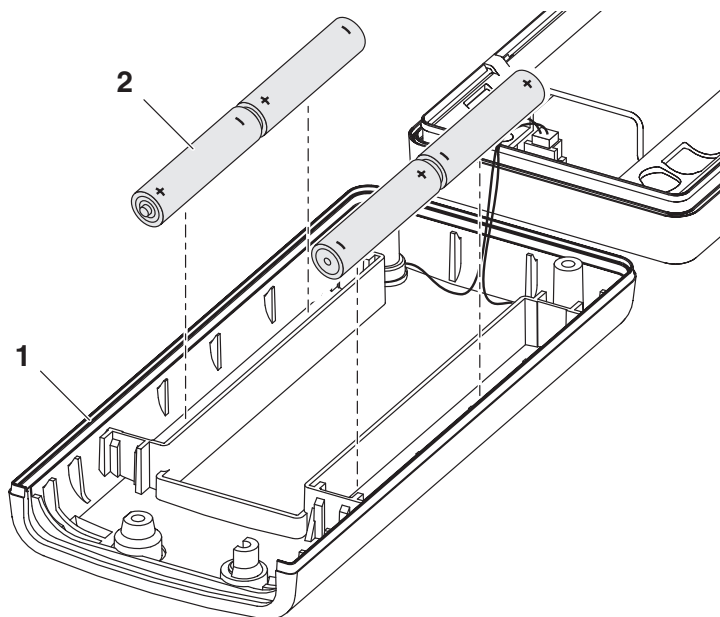

- | | |
|---|---|
| 1 | Open the housing: <ul style="list-style-type: none">– Undo the four screws on the underside of the instrument– Open the lower cover (1). |
| 2 | Take the four batteries (2) out of the battery compartment. |

Measuring instrument

Dispose of the measuring instrument without the rechargeable batteries as electronic waste at an appropriate collection point.

6 What to do if...

6.1 pH and ORP measurement

**Error message,
OFL or UFL
(measuring range
exceeded or undercut)**

Cause	Remedy
<i>Electrode:</i>	
– Air bubble in front of the diaphragm	– Remove air bubble
– Air in the diaphragm	– Extract air or moisten diaphragm
– Gel electrolyte dried out	– Replace electrode
<i>Test sample</i>	
– The pH value lies outside the measuring range	– not possible

**Error message, *Error*
(calibration error)**

Cause	Remedy
<i>Electrode:</i>	
– Diaphragm contaminated	– Clean diaphragm
– Membrane contaminated	– Clean membrane
– Moisture in the plug	– Dry plug
– Not enough electrolyte	– Top up electrolyte
– Electrode obsolete	– Replace electrode
– Electrode broken	– Replace electrode
– Socket damp	– Dry socket
<i>Calibration procedure:</i>	
– Incorrect solution temperature (without temperature sensor)	– Set up correct temperature
– Incorrect buffer solutions	– Select buffer solutions suitable for the calibration procedure
– Buffer solutions too old	– Use only once. Note the shelf life

No stable measured value

Cause	Remedy
<i>pH electrode:</i>	
– Diaphragm contaminated	– Clean diaphragm
– Membrane contaminated	– Clean membrane
<i>Test sample</i>	
– pH value not stable	– Measure with air excluded if necessary
– Temperature not stable	– Adjust temperature if necessary
<i>Electrode + test sample:</i>	
– Conductivity too low	– Use suitable electrode
– Temperature too high	– Use suitable electrode
– Organic liquids	– Use suitable electrode

Obviously incorrect measured values

Cause	Remedy
<i>pH electrode:</i>	
– Not connected	– Connect electrode
– Cable broken	– Replace electrode
– pH electrode unsuitable	– Use suitable electrode
– Temperature difference between buffer and test sample too high	– Adjust temperature of buffer or sample solutions
– Measurement procedure not suitable	– Follow special procedure

Sensor symbol flashes

Cause	Remedy
– Calibration interval expired	– Recalibrate the measuring system

6.2 ISE measurement

Error message <i>OFL</i>	Cause	Remedy
	– Measuring range exceeded	– Dilute test sample
Obviously incorrect measured values	Cause	Remedy
	– Electrode not connected	– Connect electrode
	– Cable broken	– Replace electrode
Error message, <i>Error</i> (invalid calibration)	Cause	Remedy
	<i>Ion-sensitive electrode:</i>	
	– Moisture in the plug	– Dry plug
	– Electrode obsolete	– Replace electrode
	– Electrode unsuitable for the range to be measured	– Use a suitable electrode
	– Socket damp	– Dry socket
	<i>Calibration procedure:</i>	
	– Wrong sequence of standards for three point calibration	– Select correct sequence
	– Calibration standards do not have the correct temperature (max. ± 2 °C temperature difference)	– Adjust the temperature of the calibration standards
	Warning [<i>TempErr</i>]	Cause
– Temperature difference between measurement and calibration greater than 2 K.		– Adjust the temperature of the test sample
Warning [<i>ISEErr</i>]	Cause	Remedy
	– Electrode voltage outside calibrated range	– Recalibrate

6.3 DO measurement

DO sensor was not recognized

Cause

- Sensor not connected
- Cable broken

Remedy

- Connect sensor
- Replace sensor

Error message *OFL*

Cause

- Measuring range exceeded

Remedy

- not possible

**Error message, *Error*
(invalid calibration)**

Cause

DO sensor:

- Electrolyte solution depleted
- Membrane contaminated
- Electrode system poisoned

Remedy

- Regenerate sensor
- Clean membrane
- Regenerate sensor

Error message, *LEAK*

Cause

DO sensor:

- Membrane damaged
- Membrane head screwed on not tight enough

Remedy

- Exchange the membrane cap
- Screw membrane head tight

***Measured value* flashes
for a long time
(No stable measured
value)**

Cause

DO sensor:

- Membrane contaminated

Remedy

- Clean membrane

Measured value too low

Cause

DO sensor:

- Insufficient flow

Remedy

- Provide flow to the sensor

Measured value too high

Cause	Remedy
– High amount of dissolved substances	– Correct solubility function using the salinity equivalent
– Air bubbles bump on the membrane with high velocity	– Avoid direct flow to the membrane
– The carbon dioxide pressure is too high (> 1 bar)	– Measuring not possible

Sensor symbol flashes

Cause	Remedy
– Calibration interval expired	– Recalibrate the measuring system

6.4 Conductivity measurement**Conductivity measuring cell was not recognized**

Cause	Remedy
– Measuring cell not connected	– Connect measuring cell
– Cable broken	– Replace measuring cell

Error message, *Error* (invalid calibration)

Cause	Remedy
– Measuring cell contaminated	– Clean cell and replace it if necessary
– Unsuitable control standard	– Use control standard, 0.01 mol/l KCl

Sensor symbol flashes

Cause	Remedy
– Calibration interval expired	– Recalibrate the measuring system

6.5 General errors

	Cause	Remedy
Display, LoBat	<ul style="list-style-type: none">– Batteries almost empty	<ul style="list-style-type: none">– Charge the batteries (see section 3.2)
Instrument does not react to keystroke	<ul style="list-style-type: none">– Operating condition undefined or EMC load unallowed	<ul style="list-style-type: none">– Processor reset: Press the <ON/OFF> and <CAL> key simultaneously.

7 Technical data

7.1 General data

Dimensions	approx. 172 x 80 x 37 mm	
Weight	approx. 0.3 kg (without plug-in power supply)	
Mechanical structure	Type of protection	IP 66
Electrical safety	Protective class	III
Test certificates	cETLus, CE	
Ambient conditions	Storage	- 25 °C ... + 65 °C
	Operation	-10 °C ... + 55 °C
	Climatic class	2
Power supply	Rechargeable batteries	4 x 1.2 V nickel metal hydride (NiMH), type AA
	Operational life	up to 500 h with one battery charging
	Plug-in power supply (charging device)	FRIWO FW7555M/09, 15.1432.500-00 Friwo Part. No. 1883259 Input: 100 ... 240 V ~ / 50 ... 60 Hz / 400 mA Output: 9 V = / 1,5 A Connection max. overvoltage category II Primary plugs contained in the scope of delivery: Euro, US, UK and Australian.
	Serial interface	Connection of the cable
	Baud rate	adjustable: 1200, 2400, 4800, 9600, 19200 Baud
	Type	RS232, data output
	Data bits	8
	Stop bits	2
	Parity	None
	Handshake	RTS/CTS
	Cable length	Max. 15m

Guidelines and norms used	EMC	EC guideline 89/336/EEC EN 61326-1:1998 EN 61000-3-2 A14:2000 EN 61000-3-3:1995 FCC Class A
	Instrument safety	E.C. guideline 73/23/EEC EN 61010-1 A2:1995
	Climatic class	VDI/VDE 3540
	IP protection	EN 60529:1991

FCC Class A Equipment Statement

Note: This equipment has been tested and found to comply with the limits for a Class A digital device, pursuant to Part 15 of the FCC Rules. These limits are designed to provide reasonable protection against harmful interference when the equipment is operated in a commercial environment. This equipment generates, uses, and can radiate radio frequency energy and, if not installed and used in accordance with the instruction manual, may cause harmful interference to radio communications. Operation of this equipment in a residential area is likely to cause harmful interference in which case the user will be required to correct the interference at his own expense.

7.2 Measuring ranges, resolution, accuracy

7.2.1 pH/ORP

Measuring ranges, resolution	Variable	Measuring range	Resolution
	pH	- 2.000 ... + 20.000	0.001
		- 2.00 ... + 20.00	0.01
	U [mV]	- 999.9 ... + 999.9	0.1
	- 2000 ... + 2000	1	
	T [°C]	- 5.0 ... + 105.0	0.1

Manual temperature input	Variable	Range	Increment
	T_{manual} [°C]	- 20 ... + 130	1

Accuracy (± 1 digit)	Variable	Accuracy	Temperature of the test sample
	<i>pH</i> *	± 0.004	+ 15 °C ... + 35 °C
	<i>U [mV] / range</i>		
	- 999.9 ... + 999.9	± 0.2	+ 15 °C ... + 35 °C
	- 2000 ... + 2000	± 1	+ 15 °C ... + 35 °C
	<i>T [°C] / temperature sensor</i>		
	NTC 30	± 0.2	0 °C ... + 55 °C
PT 1000	± 0.3	0 °C ... + 55 °C	

* when measuring in a range of ± 2 pH around a calibration point

7.2.2 ISE

Measuring ranges, resolution	Variable	Measuring range	Resolution
	ISE [mg/l]	0.000 ... 10.000	0.001
		0.00 ... 100.00	0.01
		0.0 ... 100.0	0.1
		0 ... 2000	1

Manual temperature input	Variable	Range	Increment
	T_{manual} [°C]	- 20 ... + 130	1

7.2.3 Dissolved oxygen

Measuring ranges, resolution

Note: The values quoted in brackets apply especially for the DurOx 325 sensor.

Variable	Measuring range	Resolution
DO concentration [mg/l]	0 ... 20.00 (0 ... 20.0) 0 ... 90.0 (0 ... 90)	0.01 (0.1) 0.1 (1)
Saturation [%]	0 ... 200.0 (0 ... 200) 0 ... 600	0.1 (1) 1
O ₂ partial pressure [mbar]	0 ... 200.0 (0 ... 200) 0 ... 1250	0.1 (1) 1
T [°C]	0 ... 50.0	0.1

Accuracy (± 1 digit)

Variable	Accuracy
DO concentration [mg/l]	± 0.5 % of measured value at ambient temperature + 5 °C ... + 30 °C
Saturation [%]	± 0.5% of measured value when measuring in the range of ± 10 K around the calibration temperature
O ₂ partial pressure [mbar]	± 0.5 % of measured value at ambient temperature + 5 °C ... + 30 °C

Correction functions

Temperature compensation	Accuracy better than 2 % at 0 ... + 40 °C
Salinity correction	0 ... 70.0 SAL
Air pressure correction	Automatic through integrated pressure sensor in the range of 500 ... 1100 mbar

7.2.4 Conductivity

Measuring ranges, resolution	Variable	Measuring range	Resolution
	κ [$\mu\text{S}/\text{cm}$]	0.000 ... 2.000*	0.001
		0.00 ... 20.00**	0.01
		0.0 ... 200.0	0.1
		0 ... 2000	1
	κ [mS/cm]	0.00 ... 20.00	0.01
		0.0 ... 200.0	0.1
		0 ... 2000	1
	Specific resistance [$\text{k}\Omega\cdot\text{cm}$]	0.000 ... 2.000	0.001
		0.00 ... 20.00	0.01
		0.0 ... 200.0	0.1
		0 ... 2000	1
	Specific resistance [$\text{M}\Omega\cdot\text{cm}$]	0.00 ... 20.00	0.01
		0.0 ... 200.0	0.1
		0 ... 2000	1
	SAL	0.0 ... 70.0 according to the IOT table	0.1
	TDS [mg/l]	0 ... 2000 Factor can be set be- tween 0.40 and 1.00	1
	T [$^{\circ}\text{C}$]	- 5.0 ... + 105.0	0.1

* only possible with cells of the cell constant, 0.010 cm^{-1}

** only possible with cells of the cell constant, 0.010 cm^{-1} or $0.090 \dots 0.110\text{ cm}^{-1}$

Cell constants	Cell constant C	Values
	Can be calibrated in the ranges	$0.450 \dots 0.500\text{ cm}^{-1}$ $0.800 \dots 1.200\text{ cm}^{-1}$
	Adjustable	0.010 cm^{-1} (fixed) $0.090 \dots 0.110\text{ cm}^{-1}$ $0.250 \dots 25.000\text{ cm}^{-1}$
Reference temperature	Reference temperature	Values
	Adjustable	$20\text{ }^{\circ}\text{C}$ (Tr20) $25\text{ }^{\circ}\text{C}$ (Tr25)

Accuracy (± 1 digit)	Variable	Accuracy	Temperature of the test sample
\mathcal{K} / Temperature compensation			
	None (Off)	± 0.5 %	
	Nonlinear (nLF)	± 0.5 %	0 °C ... + 35 °C according to EN 27 888
		± 0.5 %	+ 35 °C ... + 50 °C Extended nLF function according to WTW mea- surements
	Linear (lin)	± 0.5 %	+ 10 °C ... + 75 °C
SAL / range			
	0.0 ... 42.0	± 0.1	+ 5 °C ... + 25 °C
		± 0.2	+ 25 °C ... + 30 °C
TDS [mg/l]			
		± 1	
T [°C] / temperature sensor			
	NTC 30	± 0.2	0 °C ... + 55 °C
	PT 1000	± 0.3	0 °C ... + 55 °C

8 Lists

This chapter provides additional information and orientation aids.

Abbreviations

The list of abbreviations explains the indicators and abbreviations that appear on the display and in the manual.

Specialist terms

The glossary briefly explains the meaning of the specialist terms. However, terms that should already be familiar to the target group are not described here.

Abbreviations

κ	Conductivity value (international γ)
ASY	Asymmetry
<i>Calibration type NIST/DIN</i>	Automatic pH calibration with buffer solutions prepared according to NIST or DIN 19 266
<i>Calibration type TEC</i>	Automatic pH calibration with WTW technical buffer solutions according to DIN 19267
C	Cell constant [cm ⁻¹] (internat. k)
°C	Temperature unit, degrees Celsius
Cal	Calibration
ConCal	Conventional single-point or two-point calibration for pH measurements
d	Day
°F	Temperature unit, degrees Fahrenheit
h	Hour
j	Year
Lin	Linear temperature compensation
LoBat	Batteries almost empty (Low battery)
m	Month
mV	Voltage unit
mV/pH	Unit of the electrode slope (internat. mV)
nLF	Nonlinear temperature compensation
OFL	Display range exceeded (Overflow)
OxiCal	Automatic calibration for DO measurements
pH	pH value
S	Slope (internat. k)
SAL	Salinity
SELV	Safety Extra Low Voltage
SLO	Slope setting on calibration

TDS	Total Dissolved Solids
Tr20	Reference temperature of 20 °C
Tr25	Reference temperature of 25 °C
UFL	Display range undercut (underflow)
U	Voltage

Glossary

Adjusting	To manipulate a measuring system so that the relevant value (e. g. the displayed value) differs as little as possible from the correct value or a value that is regarded as correct, or that the difference remains within the tolerance.
Asymmetry	Designation for the offset potential of a pH electrode. It is the measurable potential of a symmetrical electrode, the membrane of which is immersed in a solution with the pH of the nominal electrode zero point (WTW electrodes: pH = 7).
AutoRange	Name of the automatic selection of the measuring range.
AutoRead	WTW name for a function to check the stability of the measured value.
Calibration	Comparing the value from a measuring system (e. g. the displayed value) to the correct value or a value that is regarded as correct. Often, this expression is also used when the measuring system is adjusted at the same time (see adjusting).
Cell constant, k	Characteristic quantity of a conductivity measuring cell, depending on the geometry.
Conductivity	Short form of the expression, specific electrical conductivity. It is a measured value of the ability of a substance to conduct an electric current. In water analysis, the electrical conductivity is a dimension for the ionized substances in a solution.
Diaphragm	The junction is a porous body in the housing wall of reference electrodes or electrolyte bridges. It forms the electrical contact between two solutions and makes electrolyte exchange more difficult. The expression, junction, is also used for ground or junction-less transitions.
DO partial pressure	Pressure caused by the oxygen in a gas mixture or liquid.
DO saturation	Short name for the relative DO saturation. Note: The DO saturation value of air-saturated water and the DO saturation value of oxygen-saturated water are different.
Electrode zero point	The zero point of a pH electrode is the pH value at which the electromotive force of the pH electrode at a specified temperature is zero. Normally, this is at 25 °C.
Electromotive force of an electrode	The electromotive force U of the electrode is the measurable electromotive force of an electrode in a solution. It equals the sum of all the galvanic voltages of the electrode. Its dependency on the pH results in the electrode function which is characterized by the parameters, slope and zero point.

Measured value	The measured value is the special value of a measured parameter to be determined. It is given as a combination of the numerical value and unit (e. g. 3 m; 0.5 s; 5.2 A; 373.15 K).
Measured variable	The measured parameter is the physical dimension determined by measuring, e. g. pH, conductivity or DO concentration.
Measuring system	The measuring system comprises all the devices used for measuring, e. g. measuring instrument and sensor. In addition, there is the cable and possibly an amplifier, terminal strip and armature.
Molality	Molality is the quantity (in Mol) of a dissolved substance in 1000 g solvent.
MultiCal®	WTW name stating that a measuring instrument provides several calibration procedures.
Offset potential	The measurable potential of a symmetrical electrode, the membrane of which is immersed in a solution with the pH of the nominal electrode zero point. The asymmetry is part of the offset potential.
ORP voltage	The ORP is caused by oxidizing or reducing substances dissolved in water if these substances become effective on an electrode surface (e. g. a gold or platinum surface).
OxiCal®	WTW name for a procedure to calibrate DO measuring systems in water vapor saturated air.
pH value	The pH is a measure of the acidic or basic effect of an aqueous solution. It corresponds to the negative decadic logarithm of the molal hydrogen ions activity divided by the unit of the molality. The practical pH value is the value of a pH measurement.
Potentiometry	Name of a measuring technique. The signal (depending on the measured parameter) of the electrode is the electrical potential. The electrical current remains constant.
Reference temperature	Fixed temperature value to compare temperature-dependent measured values. For conductivity measurements, the measured value is converted to a conductivity value at a reference temperature of 20 °C or 25 °C.
Reset	Restoring the original condition of all settings of a measuring system.
Resistance	Short name for the specific electrolytic resistance. It corresponds to the reciprocal value of the electrical conductivity.
Resolution	Smallest difference between two measured values that can be displayed by a measuring instrument.

Salinity	The absolute salinity S_A of seawater corresponds to the relationship of the mass of dissolved salts to the mass of the solution (in g/Kg). In practice, this dimension cannot be measured directly. Therefore, the practical salinity is used for oceanographic monitoring. It is determined by measuring the electrical conductivity.
Salt content	General designation for the quantity of salt dissolved in water.
Setting the temperature compensation	Name of a function that considers the temperature influence on the measurement and converts it accordingly. Depending on the measured parameter to be determined, the temperature compensation functions in different ways. For conductimetric measurements, the measured value is converted to a defined reference temperature. For potentiometric measurements, the slope value is adjusted to the temperature of the test sample but the measured value is not converted.
Slope	The slope of a linear calibration function.
Slope (relative)	Designation used by WTW in the DO measuring technique. It expresses the relationship of the slope value to the value of a theoretical reference sensor of the same type of construction.
Standard solution	The standard solution is a solution where the measured value is known by definition. It is used to calibrate a measuring system.
TDS	Total dissolved solids
Temperature coefficient	Value of the slope of a linear temperature function.
Temperature function	Name of a mathematical function expressing the temperature behavior of a test sample, a probe or part of a probe.
Test sample	Designation of the test sample ready to be measured. Normally, a test sample is made by processing the original sample. The test sample and original sample are identical if the test sample was not processed.

9 Index

A

Air calibration vessel	53
Asymmetry of the pH electrode	30
Authorized use	9
Automatic switchoff	11, 13
AutoRead	
DO	51, 53
ISE	42
ORP	28
pH	27

B

Batteries	
Charging	11
Charging time	11
Buffer sets, pH	30

C

Calibration	
conductivity	63
DO	53
ISE	43
pH	30
Calibration evaluation	
DO	54
ISE	45
Calibration points	
ISE	44
pH	31
Calibration records	74
Cell constant	63
Cleaning	81
Comparison measurement (DO)	53
Conductivity calibration evaluation	64
Connecting a PC	77
Connecting a printer	77
Connecting a sensor	7
Control standard of conductivity	63

D

Data filter	72
Dataset	66
Date and time	19
Delivery condition	
measuring parameters	78
system settings	79

Display	7
Display illumination	7, 11, 13
Drift control	
DO	51
ISE	42
ORP	28
pH	27

F

Filter	72
Firmware update	103

I

Initial commissioning	12
Initialization	78
ISE standard solutions	44

K

Key functions	6
Keys	6

M

Mains operation	11
Manual storage	67
Measured value display	15
Measurement dataset	66
Measuring	
conductivity	59
DO	50
ISE	42
ORP voltage	28
pH	27
Measuring data storage	
edit	70
erase	70
Measuring menu	
conductivity	61
DO	52
ISE	43
pH/ORP	29
Measuring ranges	
Conductivity	93
Measuring window	7
Menus (navigation)	15
Messages	16

MultiLab pilot	77	Three-point calibration	
O		ISE	48
Obligations of the purchaser	10	pH	37
Operating safety	10	Transmitting data	76
P		Transmitting measured values	76
pH calibration evaluation	33	Two-point calibration	
Plug-in power supply	11	ISE	47
Print	76	pH	36, 38
R			
Reset	78		
RS232 socket assignment	77		
S			
Safe operation	10		
Safety	9		
Scope of delivery	11		
Single-point calibration			
pH	35, 38		
Slope			
ISE	43		
pH	30		
relative (DO sensor)	53		
Socket field	7		
Status line	7		
Storage	66		
at intervals	68		
automatic	68		
Storage administration	69		
Storage interval	68		
Storage of measured values			
storage locations	66		
System menu	21		
Display	22		
General	23		
storage	70		
T			
Target group	9		
Temperature compensation	60		
Temperature measurement			
conductivity	58		
ISE	41, 49		
pH	25		

Appendix: Firmware Update

General

The program "Firmware Update 350i" enables you to update the firmware of the Multi 350i handheld instrument to the latest version using a PC. To do so, you need a free serial (COM) port on your PC and the AK 340/B interface cable (contained in the scope of delivery of the Multi 350i).

Program installation

Together with the program "Multi350i_Vx_yy_English.exe", you install the firmware update program on your PC.

Program start

Execute the program "Update350i" via the Windows start menu. The program automatically selects the first free serial (COM) port. The selected port is displayed on the left-hand side of the status bar at the bottom edge of the window.

Via the Language menu, you can change the language.

Firmware update

Gehen Sie wie folgt vor:

1	Using the AK 340/B interface cable, connect the Multi 350i to be programmed to the serial (COM) port displayed in the status bar.
2	Make sure the Multi 350i is switched on.
3	Click the OK button to start the update process.
4	Proceed by following the instructions of the program. During the programming process, a corresponding message and a continuation display (in %) are displayed. The programming process takes about 4 minutes. After successful programming, a final message appears. The programming process is finished now.
5	Disconnect the instrument from the PC. The instrument is ready for operation.

After switching Off/On you can check whether the new software version was taken over in the start display of the instrument.



Wissenschaftlich-Technische Werkstätten GmbH

Dr.-Karl-Slevogt-Straße 1
D-82362 Weilheim

Germany

Tel: +49 (0) 881 183-0
+49 (0) 881 183-100
Fax: +49 (0) 881 183-420
E-Mail: Info@WTW.com
Internet: <http://www.WTW.com>