

OPERATING MANUAL

ba75863e19 04/2015



Multi 3410

DIGITAL METER FOR DIGITAL IDS SENSORS



a xylem brand



The latest version of the present operating manual is available on the Internet under www.wtw.com.

Copyright

© 2015, WTW GmbH
Reproduction in whole - or even in part - is prohibited without the express written permission of WTW GmbH, Weilheim.
Printed in Germany.

Multi 3410 - Contents

1	Overview	7
1.1	Keypad	7
1.2	Display	9
1.3	Socket field	11
1.4	Automatic sensor recognition	12
1.5	IDS sensors	12
1.6	IDS adapter for analog sensors	13
2	Safety	15
2.1	Authorized use	16
2.2	General safety instructions	16
3	Commissioning	19
3.1	Scope of delivery	19
3.2	Power supply	19
3.3	Initial commissioning	19
3.3.1	Inserting the rechargeable batteries	20
3.3.2	Connecting the power pack / charging the batteries	20
3.3.3	Switching on the meter	21
3.3.4	Setting the date and time	22
4	Operation	23
4.1	Switching on the meter	23
4.2	Login with a user name	23
4.3	General operating principles	26
4.3.1	Operating modes	26
4.3.2	Navigation	26
4.3.3	Example 1 on navigation: Setting the language	29
4.3.4	Example 2 on navigation: Setting the date and time	31
4.4	Sensor-independent settings	32
4.4.1	<i>System</i>	32
4.4.2	<i>Data storage</i>	34
4.4.3	<i>Automatic Stability control</i>	34
4.4.4	<i>Automatic switch-off</i>	35
4.4.5	<i>Display illumination</i>	35
4.5	Sensor info	35

4.6	pH value.	37
4.6.1	General information	37
4.6.2	Measuring the pH value	37
4.6.3	Settings for pH measurements	39
4.6.4	pH calibration	41
4.6.5	Calibration interval	45
4.6.6	Carrying out an automatic calibration (AutoCal)	46
4.6.7	Carrying out a manual calibration (ConCal)	50
4.6.8	Displaying calibration records.	54
4.6.9	Continuous measurement control (CMC function)	55
4.6.10	QSC function (sensor quality control)	56
4.7	ORP voltage	59
4.7.1	General information	59
4.7.2	Measuring the ORP	59
4.7.3	Settings for ORP measurements	61
4.8	Dissolved oxygen.	62
4.8.1	General information	62
4.8.2	Measuring.	63
4.8.3	Settings for D.O. sensors (menu or measurement and calibration settings)	65
4.8.4	FDO [®] Check procedure (check of the FDO [®] 925)	68
4.8.5	D.O. calibration.	70
4.8.6	Displaying calibration records.	73
4.9	Conductivity	74
4.9.1	General information	74
4.9.2	Measuring.	74
4.9.3	Temperature compensation	77
4.9.4	Settings for IDS conductivity sensors	78
4.9.5	Determining the cell constant (calibration in control standard)	81
4.9.6	Displaying calibration records.	83
4.10	Turbidity measurement (VisoTurb [®] 900-P)	84
4.10.1	General information	84
4.10.2	Measuring.	85
4.10.3	Settings for turbidity sensors	86
4.10.4	Calibration.	87
4.10.5	Calibration data.	90
4.11	Data storage	93
4.11.1	Manual storage.	94
4.11.2	Automatic storage at intervals	94
4.11.3	Editing the measurement data storage.	97
4.11.4	Erasing the measurement data storage	98
4.12	Transmitting data.	99
4.12.1	USB interfaces	99
4.12.2	Connecting the PC (USB-B interface (USB Device))	99

4.12.3	Connecting a USB memory device/USB printer (USB-A interface (<i>USB Host</i>))	100
4.12.4	Options for data transmission to the USB-B (PC) interface and the USB-A (USB printer) interface	100
4.12.5	Data transmission to the USB-A interface (USB memory device)	101
4.12.6	MultiLab Importer	102
4.13	MultiLab User	102
4.14	Reset	102
4.14.1	Resetting the measurement settings	102
4.14.2	Resetting the system settings	105
5	Maintenance, cleaning, disposal	107
5.1	Maintenance	107
5.1.1	Replacing the rechargeable batteries	107
5.2	Cleaning	108
5.3	Packing	108
5.4	Disposal	108
6	What to do if...	109
6.1	General information	109
6.2	pH	112
6.3	Dissolved oxygen	113
6.4	Conductivity	114
6.5	Turbidity	115
7	Technical data	117
7.1	General data	117
7.2	Measuring ranges, resolution, accuracy	118
8	Lists	119
9	Appendix: Firmware update	123
9.1	Firmware update for the meter Multi 3410	123
9.2	Firmware-Update for IDS Sensors	124

1 Overview

The compact, digital precision meter Multi 3410 enables you to carry out pH measurements, ORP measurements, conductivity measurements, dissolved oxygen (D.O.) measurements and turbidity measurements quickly and reliably.

The Multi 3410 provides the maximum degree of operating comfort, reliability and measuring certainty for all applications.

The Multi 3410 supports you in your work with the following functions:

- proven calibration procedures
- automatic stability control (AR),
- automatic sensor recognition,
- CMC (continuous measurement control)
- QSC (sensor quality control).

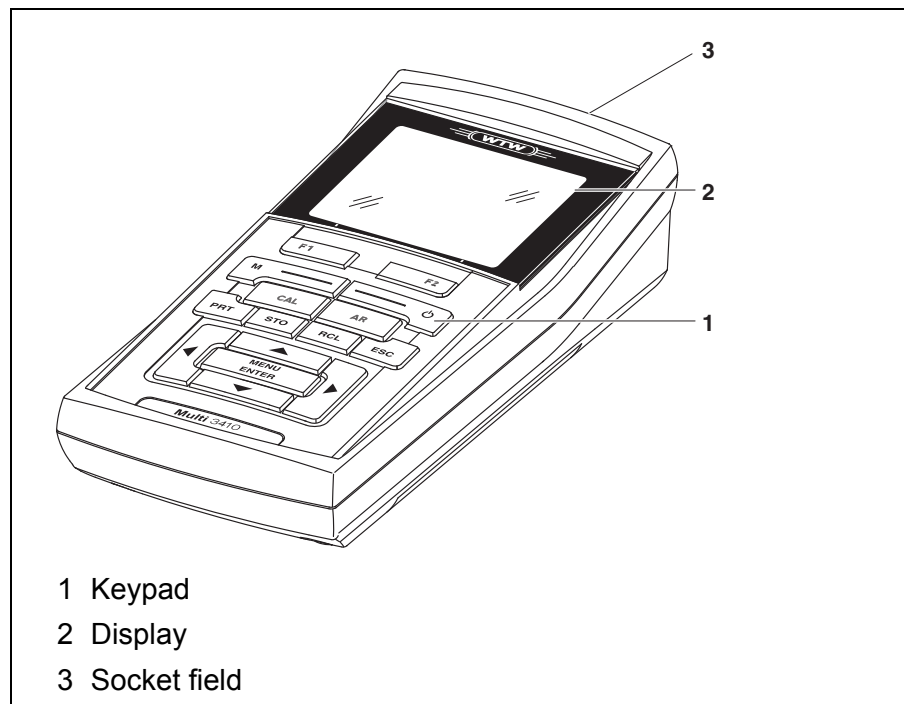











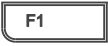

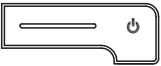
The two USB interfaces (USB-A and USB-B) enable you to:

- Transmit data to
 - a USB memory device
 - a PC
- Update the meter firmware.

1.1 Keypad

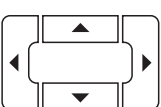
In this operating manual, keys are indicated by brackets <...> .





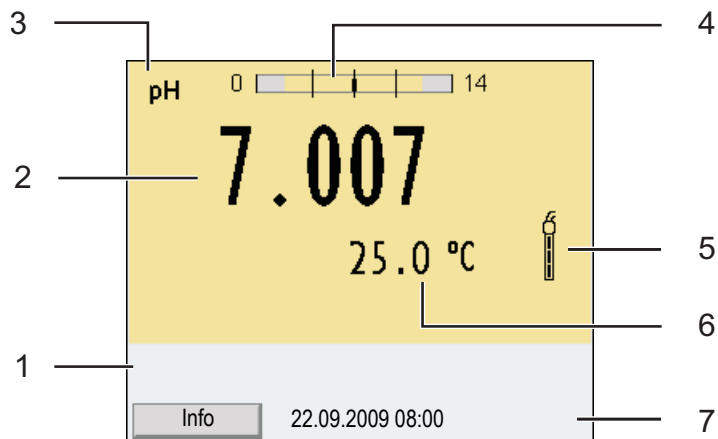

The key symbol (e.g. <MENU/ENTER>) generally indicates a short keystroke (under 2 sec) in this operating manual. A long keystroke (approx. 2 sec) is indicated by the underscore behind the key symbol (e.g. <MENU/ENTER__>).

	<F1>: <F2>:	Softkeys providing situation dependent functions, e.g.: <F1>/[Info]: View information on a sensor
		
	<On/Off>: <On/Off__>:	Switches the meter on or off
	<M>:	Selects the measured parameter
	<CAL>: <CAL__>:	Calls up the calibration procedure Displays the calibration data
	<AR>	Freezes the measured value (HOLD function) Switches the AutoRead measurement on or off
	<STO>: <STO__>:	Saves a measured value manually Opens the menu for the automatic save function
	<RCL>: <RCL__>:	Displays the manually stored measured values Displays the automatically stored measured values
	<▲><▼>: <◀><▶>:	Menu control, navigation
	<MENU/ENTER>: <MENU/ENTER__>:	Opens the menu for measurement settings / Confirms entries Opens the menu for system settings
	<PRT> <PRT__>	Outputs stored data to the interface Outputs displayed data to the interface in intervals
	<ESC>:	Cancels an action

1.2 Display



1	Status information
2	Measured value (with unit)
3	Measured parameter
4	Continuous measurement control (CMC function)
5	Sensor symbol (calibration evaluation, calibration interval)
6	Measured temperature (with unit)
7	Softkeys and date + time

Function display indicators		
	AutoCal e.g. TEC	Calibration with automatic buffer recognition, e.g. with the buffer set: Technical buffers
	ConCal	Calibration with any buffers
	Error	An error occurred during calibration
	AR	Stability control (AutoRead) is active
	HOLD	Measured value is frozen (<AR> key)
		Batteries are almost empty
		Mains operation
		Mains operation with charge function Batteries are automatically charged in the background.
		Data are automatically output to the USB-B interface at intervals
		Data are output to the USB-A interface (USB flash drive)
		Data are output to the USB-A interface (USB printer) If there is a USB-B connection (such as to a PC) at the same time, the data are output only to the USB-B interface.
		Power supply via the USB-B interface Batteries are not being charged

1.3 Socket field

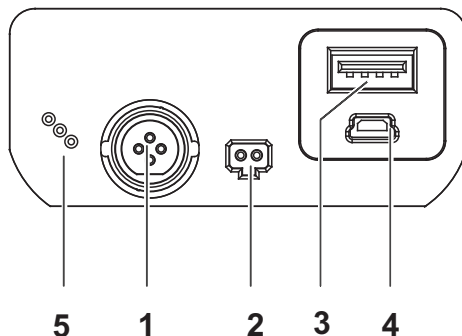

Connectors:

1	Digital sensors (pH, ORP, conductivity, D.O.)
2	Power pack
3	USB-A (host) interface
4	USB B (device) interface
5	Service interface



CAUTION

Only connect sensors to the meter that cannot return any voltages or currents that are not allowed (> SELV and > current circuit with current limiting).

WTW IDS sensors and IDS adapters meet these requirements.

1.4 Automatic sensor recognition

The automatic sensor recognition for IDS sensors allows

- to operate an IDS sensor at different meters without recalibration
- to operate different IDS sensors at one meter without recalibration
- to assign measurement data to an IDS sensor
 - Measurement datasets are always stored and output with the sensor name and sensor series number.
- to assign calibration data to an IDS sensor
 - Calibration data and calibration history are always stored and output with the sensor name and sensor series number.
- to activate the correct cell constant for conductivity sensors automatically
- to hide menus automatically that do not concern this sensor

To be able to use the automatic sensor recognition, a meter that supports the automatic sensor recognition (e.g. Multi 3410) and a digital IDS sensor are required.

In digital IDS sensors, sensor data are stored that clearly identify the sensor.

The sensor data are automatically taken over by the meter.

1.5 IDS sensors

IDS sensors

- support the automatic sensor recognition
- show only the settings relevant to the specific sensor in the setting menu
- process signals in the sensor digitally so that precise and interference-free measurements are enabled even with long cables
- facilitate to assign a sensor to a measured parameter with differently colored couplings
- have quick-lock couplings with which to fix the sensors to the meter.



Note

Information on available IDS sensors is given on the Internet and in the WTW catalog, "Laboratory and field instrumentation".

Sensor data from IDS sensors

IDS sensors transmit the following sensor data to the meter:

- **SENSOR ID**
 - Sensor name
 - Sensor series number
- **Calibration data**
 - Calibration date
 - Calibration characteristics
 - Calibration interval
 - Selected buffer set (IDS pH sensors only)
 - Cell constant (IDS conductivity sensors only)
 - Calibration history of the last 10 calibrations
- **Measurement settings (IDS conductivity sensors only)**
 - The set measured parameter
 - The set reference temperature
 - The set temperature coefficient
 - The set TDS factor

The calibration data are updated in the IDS sensor after each calibration procedure. A message is displayed while the data are being updated in the sensor.



Note

In the measured value display, you can display the sensor name and series number of the selected sensor with the [Info] softkey. You can then display all further sensor data stored in the sensor with the [More] softkey.

1.6 IDS adapter for analog sensors

With the aid of an IDS adapter, you can also operate analog sensors on the Multi 3410. An IDS adapter and analog sensor together behave like an IDS sensor.

The measuring electronics with the stored adapter data are in the adapter head. The adapter data correspond to the sensor data.



Note

Information on available IDS adapters is given on the Internet and in the WTW catalog, "Laboratory and field instrumentation". Detailed information on the IDS adapter is given in the operating manual of the adapter.

2 Safety

This operating manual contains basic instructions that you must follow during the commissioning, operation and maintenance of the meter. Consequently, all responsible personnel must read this operating manual before working with the meter.

The operating manual must always be available within the vicinity of the meter.

Target group

The meter was developed for work in the field and in the laboratory. Thus, we assume that, as a result of their professional training and experience, the operators will know the necessary safety precautions to take when handling chemicals.

Safety instructions

Safety instructions in this operating manual are indicated by the warning symbol (triangle) in the left column. The signal word (e.g. "Caution") indicates the level of danger:



WARNING

indicates instructions that must be followed precisely in order to avoid possibly great dangers to personnel.



CAUTION

indicates instructions that must be followed precisely in order to avoid the possibility of slight injuries or damage to the meter or the environment.

Further notes



Note

indicates notes that draw your attention to special features.



Note

indicates cross-references to other documents, e.g. operating manuals.

Function and operational safety**2.1 Authorized use**

The authorized use of the meter consists exclusively of the measurement of the pH, ORP, conductivity and dissolved oxygen in a field and laboratory environment.

The technical specifications as given in chapter 7 TECHNICAL DATA must be observed. Only the operation and running of the meter according to the instructions given in this operating manual is authorized.

Any other use is considered **unauthorized**.

2.2 General safety instructions

This meter is constructed and tested in compliance with the IEC 1010 safety regulations for electronic measuring instruments.

It left the factory in a safe and secure technical condition.

The smooth functioning and operational safety of the meter can only be guaranteed if the generally applicable safety measures and the specific safety instructions in this operating manual are followed during operation.

The smooth functioning and operational safety of the meter can only be guaranteed under the environmental conditions that are specified in chapter 7 TECHNICAL DATA.

If the meter was transported from a cold environment to a warm environment, the formation of condensate can lead to the faulty functioning of the meter. In this event, wait until the temperature of the meter reaches room temperature before putting the meter back into operation.

CAUTION

The meter is only allowed to be opened by authorized personnel.

Safe operation

If safe operation is no longer possible, the meter must be taken out of service and secured against inadvertent operation!

Safe operation is no longer possible if the meter:

- has been damaged in transport
- has been stored under adverse conditions for a lengthy period of time
- is visibly damaged
- no longer operates as described in this manual.

If you are in any doubt, please contact the supplier of the meter.

Obligations of the purchaser

The purchaser of this meter must ensure that the following laws and guidelines are observed when using dangerous substances:

- EEC directives for protective labor legislation
- National protective labor legislation
- Safety regulations
- Safety datasheets of the chemical manufacturers.

**CAUTION**

In addition to the safety instructions mentioned here, also follow the safety instructions of the sensors used.

The operating manuals of the sensors are available on the supplied CD and on the Internet under www.wtw.com.

3 Commissioning

3.1 Scope of delivery

- Meter Multi 3410
- 4 NiMH rechargeable batteries 1.2 V Mignon type AA
- USB cable (A plug on mini B plug)
- Power pack
- Short instructions
- Detailed operating manual (4 languages)
- CD-ROM

3.2 Power supply

The Multi 3410 is supplied with power in the following ways:

- Battery operation with NiMh rechargeable batteries
- Mains operation with the supplied power pack.
The NiMh rechargeable batteries are automatically charged while the power pack is connected.
- USB operation via a connected USB-B cable.
The inserted NiMh rechargeable batteries are not charged

3.3 Initial commissioning

Perform the following activities:

- Insert the rechargeable batteries and charge them
- Connect the power pack (mains operation / battery charging)
- Switch on the meter
- Set the date and time

3.3.1 Inserting the rechargeable batteries

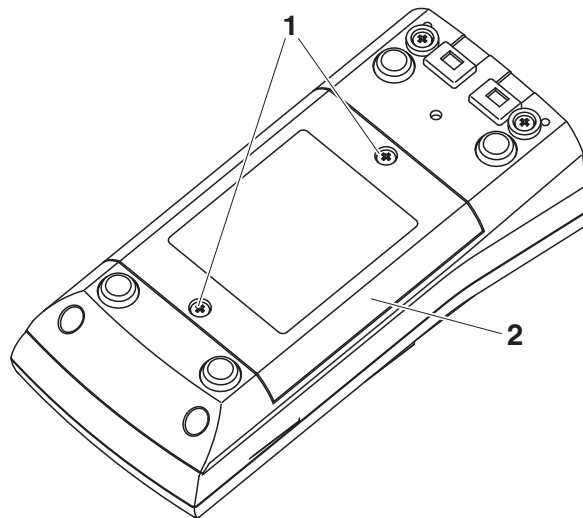

- | | |
|---|---|
| 1 | Unscrew the two screws (1) on the underside of the meter. |
| 2 | Open the battery compartment (2) on the underside of the meter. |



CAUTION

Make sure that the poles of the rechargeable batteries are positioned correctly. The \pm signs on the batteries must correspond to the \pm signs in the battery compartment.

- | | |
|---|--|
| 3 | Place four rechargeable batteries (type Mignon AA) in the battery compartment. |
| 4 | Close the battery compartment (2) and tighten the screws (1). |

3.3.2 Connecting the power pack / charging the batteries



CAUTION

The line voltage at the operating site must lie within the input voltage range of the original power pack (see section 7.1).



CAUTION

Use original power packs only (see section 7.1).



CAUTION



The batteries in the battery compartment are automatically charged when the power pack is connected.

Make sure that only NiMH rechargeable batteries are in the battery compartment. The charging process is optimized for NiMH rechargeable batteries. Other battery types can cause damage during the charging process.

Make sure that the ambient temperature is max. 40 °C while the power pack is connected.

1	Connect the plug of the power pack to the socket for the power pack on the Multi 3410.
2	Connect the original power pack to an easily accessible power outlet.

During mains operation, one of the following symbols is displayed:

	: Mains operation with charge function Batteries are automatically charged in the background.
	: Mains operation



Note

Charge the batteries completely prior to putting the meter into operation for the first time. The charging process takes approx. 10 hours. The  symbol is displayed if the batteries are nearly discharged.

3.3.3 Switching on the meter

1	Press the <On/Off> key. The meter performs a self-test. The display shows the manufacturer's logo while the self-test is being performed.
2	Connect the sensor. The meter switches to the measuring mode (measured value display).



Note

The meter has an energy saving feature to avoid unnecessary power consumption during battery operation. The energy saving feature switches off the meter during battery operation if no key is pressed during the adjusted interval. (How to set the switch-off interval, see section 4.4). The switch-off interval of the energy saving feature is not active when the meter is supplied with power via the power pack or the USB-B

cable.

3.3.4 Setting the date and time

3	See section 4.3.4
---	-------------------

4 Operation

4.1 Switching on the meter

Switching on

Press the <On/Off> (or <On/Off __>) key.

The meter performs a self-test.

The display shows the manufacturer's logo while the self-test is being performed.

If a sensor is connected, the measured value display appears.

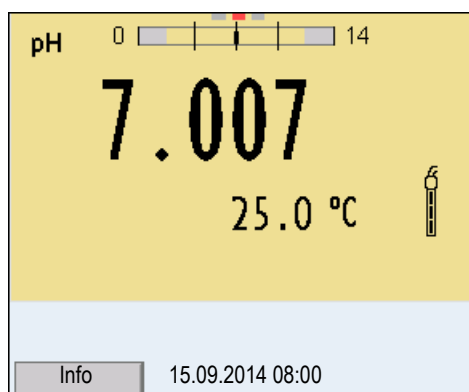

Note

If the user administration function is activated, the *Login* dialog appears after the meter is switched on (see section 4.2).

The user administration function is not active in the delivery condition. The user administration function is activated by the administrator via the *MultiLab User* PC software (see the *MultiLab User* operating manual).

Switching off

Press the <On/Off> (or <On/Off __>) key.

4.2 Login with a user name

After activation of the user administration by the administrator, measurements are only possible after login with a user name. The user name is documented with the measured values and in records.

All user names entered by the administrator are listed in the *User name* menu. The administrator determines for each user whether or not a password is required for login to the meter.

If the *Password* menu item is grayed out, no password is required for login.

- 1 Switch on the meter with <On/Off> (or <On/Off __>). The *Login* dialog box appears.

- 2 Using <▲><▼>, enter the *User name* menu item and confirm with <MENU/ENTER>. The user name is highlighted.
- 3 Using <▲><▼>, select a user name and confirm with <MENU/ENTER>.

**Note**

The login is done immediately if no password is required.
If a sensor is connected the measured value display appears.

- 4 If a password is required:
Using <▲><▼>, enter the *Password* menu item and confirm with <MENU/ENTER>.

**Note**

The user specifies the password when he or she first logs in with a user name.

A valid password consists of 4 digits.

The user can change the password with the next login.

- 5 Change the digit of the highlighted position with <▲><▼>. Go to the next digit of the password with <◀><▶>. When the password was completely entered, confirm with <MENU/ENTER>. The login takes place. If a sensor is connected the measured value display appears.

Changing the password

If the administrator has set up the access with password protection:

1	Switch on the meter with <On/Off> (or <On/Off__>). The <i>Login</i> dialog box appears.
2	Using <▲><▼> , enter the <i>User name</i> menu item and confirm with <MENU/ENTER> . The user name is highlighted.
3	Using <▲><▼> , select a user name and confirm with <MENU/ENTER> .
4	Using <▲><▼> , enter the <i>Change password</i> menu item and confirm with <MENU/ENTER> .
5	Enter the old password in the <i>Password</i> box with <▲><▼> and <◀><▶> and confirm with <MENU/ENTER> .
6	Enter the new password in the <i>New password</i> box with <▲><▼> and <◀><▶> and confirm with <MENU/ENTER> . The password is changed. The login takes place. If a sensor is connected the measured value display appears.

Forgotten the password?

Contact the administrator.

4.3 General operating principles

This section contains basic information on the operation of the Multi 3410.

Operating elements, display

An overview of the operating elements and the display is given in section 1.1 and section 1.2.

Operating modes, navigation

An overview of the operating modes and navigation of the Multi 3410 is given in section 4.3.1 and section 4.3.2.

4.3.1 Operating modes

The meter has the following operating modes:

- Measuring
The measurement data of the connected sensor is shown in the measured value display
- Calibration
The course of a calibration with calibration information, functions and settings is displayed
- Storage in memory
The meter stores measuring data automatically or manually
- Data transmission
The meter transmits measuring data and calibration records to a USB-B interface automatically or manually.
- Setting
The system menu or a sensor menu with submenus, settings and functions is displayed

4.3.2 Navigation

Measured value display

In the measured value display, you can

- open the menu for calibration and measurement settings with **<MENU/ENTER>** (short keystroke)
- open the system menu with the sensor-independent settings by pressing **<MENU/ENTER>** *Storage & config* for a **<MENU/ENTER __>** long keystroke, approx. 2 s).
- change the display in the selected measuring window (e. g. pH ><-mV) by pressing **<M>**.

Menus and dialogs

The menus for settings and dialogs in procedures contain further sub-menus. The selection is made with the <▲><▼> keys. The current selection is displayed with a frame.

- Submenus

The name of the submenu is displayed at the upper edge of the frame. Submenus are opened by confirming with <MENU/ENTER>. Example:

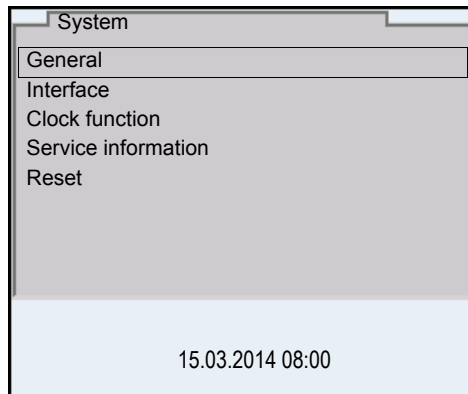

- Settings

Settings are indicated by a colon. The current setting is displayed on the right-hand side. The setting mode is opened with <MENU/ENTER>. Subsequently, the setting can be changed with <▲><▼> and <MENU/ENTER>. Example:

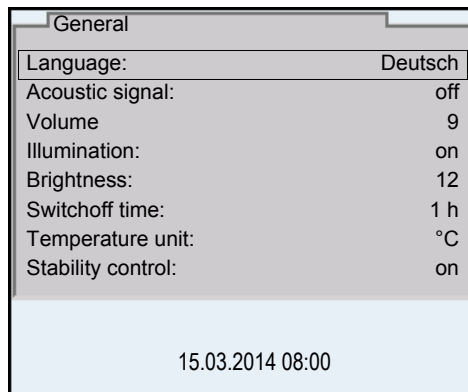

- Functions

Functions are designated by the name of the function. They are immediately carried out by confirming with <MENU/ENTER>. Example: Display the *Calibration record* function.

pH

Calibration record

Calibration data storage

Buffer: *TEC*

Single-point calibration: yes

Calibration interval: 7 d

Unit for slope: mV/pH

[i] 2.00 4.01 7.00 10.01 (25 °C)

15.03.2014 08:00

- **Messages**

Information is marked by the [i] symbol. They cannot be selected.

Example:

pH

Calibration record

Calibration data storage

Buffer: *TEC*

Single-point calibration: yes

Calibration interval: 7 d

Unit for slope: mV/pH

[i] 2.00 4.01 7.00 10.01 (25 °C)

15.03.2014 08:00



Note

The principles of navigation are explained in the two following sections by reference of examples:

- Setting the language (section 4.3.3)
- Setting the date and time (see section 4.3.4).

4.3.3 Example 1 on navigation: Setting the language

- 1 Press the **<On/Off>** key.
The measured value display appears.
The instrument is in the measuring mode.

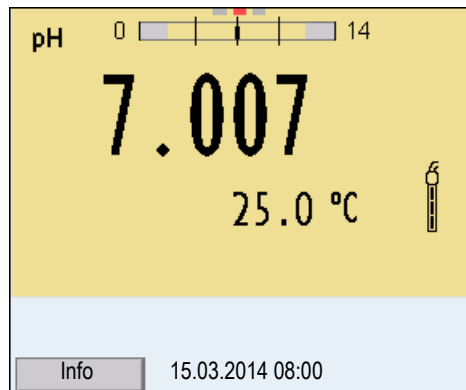

- 2 Open the *Storage & config* menu with **<MENU/ENTER __>**.
The instrument is in the setting mode.

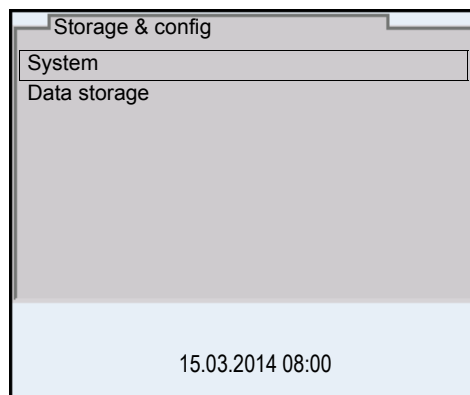

- 3 Select the *System* submenu with **<▲><▼>**.
The current selection is displayed with a frame.
- 4 Open the *System* submenu with **<MENU/ENTER>**.

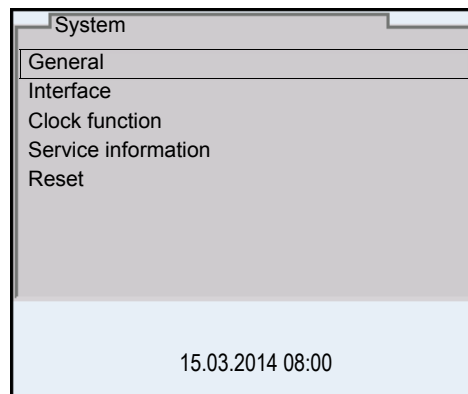

- 5 Select the *General* submenu with <▲><▼>. The current selection is displayed with a frame.
- 6 Open the *General* submenu with <MENU/ENTER>.

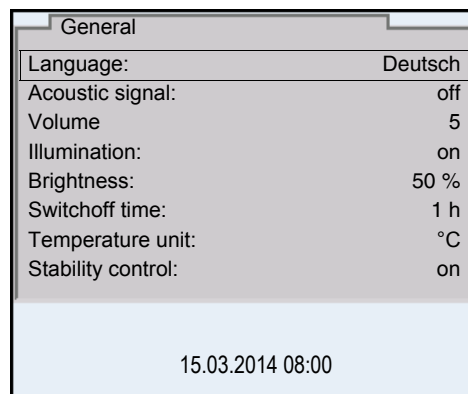

- 7 Open the setting mode for the *Language* with <MENU/ENTER>.

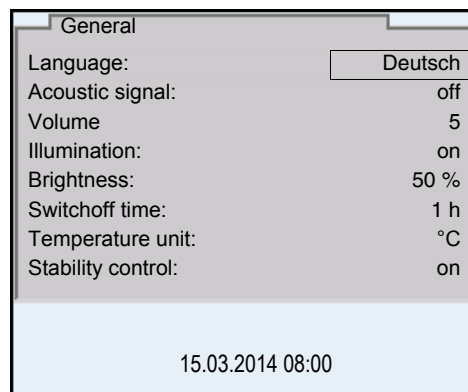

- 8 Select the required language with <▲><▼>.

- 9 | Confirm the setting with **<MENU/ENTER>**.
The meter switches to the measuring mode.
The selected language is active.

4.3.4 Example 2 on navigation: Setting the date and time

The measuring instrument has a clock with a date function. The date and time are indicated in the status line of the measured value display. When storing measured values and calibrating, the current date and time are automatically stored as well.

The correct setting of the date and time and date format is important for the following functions and displays:

- Current date and time
- Calibration date
- Identification of stored measured values.

Therefore, check the time at regular intervals.



Note

After a fall of the supply voltage (empty batteries), the date and time are reset.

Setting the date, time and date format

The date format can be switched from the display of day, month, year (*dd.mm.yy*) to the display of month, day, year (*mm/dd/yy* or *mm.dd.yy*).

- 1 | In the measured value display:
Open the *Storage & config* menu with **<MENU/ENTER __>**.
The instrument is in the setting mode.
- 2 | Select and confirm the *System / Clock function* menu with **<▲><▼>** and **<MENU/ENTER>**.
The setting menu for the date and time opens up.

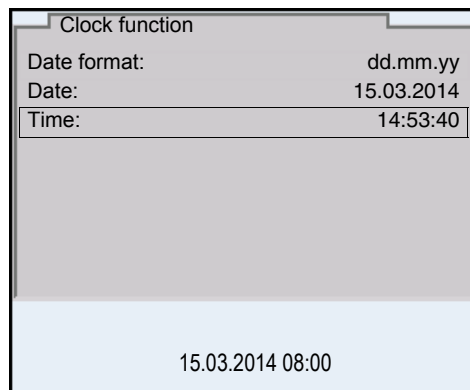

3	Select and confirm the <i>Time</i> menu with <▲><▼> and <MENU/ENTER>. The hours are highlighted.
4	Change and confirm the setting with <▲><▼> and <MENU/ENTER>. The minutes are highlighted.
5	Change and confirm the setting with <▲><▼> and <MENU/ENTER>. The seconds are highlighted.
6	Change and confirm the setting with <▲><▼> and <MENU/ENTER>. The time is set.
7	If necessary, set the <i>Date</i> and <i>Date format</i> . The setting is made similarly to that of the time.
8	To make further settings, switch to the next higher menu level with <ESC>. or Switch to the measured value display with <M>. The instrument is in the measuring mode.

4.4 Sensor-independent settings

The *Storage & config* menu includes the following settings:

- *System* (see section 4.4.1).
- *Data storage* (see section 4.4.2)

4.4.1 System

Overview

The following sensor-independent meter characteristics can be adjusted in the *Storage & config/System* menu:

- Menu language
- Beep on keystroke
- Loudness of the beep
- Illumination
- Brightness
- Interval of the automatic switchoff
- Data interface
- Clock and date function
- Reset of all sensor-independent system settings to the default condition

Settings To open the *Storage & config* menu, press the **<MENU/ENTER__>** key in the measured value display. After completing the settings, switch to the measured value display with **<M>**.
Default settings are printed in **bold**.

Menu item	Setting	Description
<i>System / General / Language</i>	<i>Deutsch</i> English (more)	Selects the menu language
<i>System / General / Acoustic signal</i>	Beep 1 <i>Beep 2</i> <i>off</i>	Switches on/off the beep on keystroke
<i>System / General / Volume</i>	0 ... 5 ... 10	Changes the loudness of the beep
<i>System / General / Illumination</i>	<i>Auto</i> on	Switches the display illumination on/off
<i>System / General / Brightness</i>	0 ... 15 ... 22	Changes the display brightness
<i>System / General / Switchoff time</i>	10 min ... 1h ... 24 h	Adjusts the switch-off time
<i>System / General / Temperature unit</i>	°C °F	Temperature unit, degrees Celsius or degrees Fahrenheit. All temperatures are displayed with the selected unit.
<i>System / General / Stability control</i>	on <i>off</i>	Switches on or off the automatic stability control during measurement (see section 4.4.3)
<i>System / Interface / Baud rate</i>	1200, 2400, 4800 , 9600, 19200	Baud rate of the USB Device interface
<i>System / Interface / Output format</i>	ASCII <i>CSV</i>	Output format for data transmission For details, see section 4.12
<i>System / Interface / Decimal separator</i>	Dot (xx.x) <i>Comma (xx,x)</i>	Decimal separator
<i>System / Interface / Output header</i>		Output of a header for <i>Output format: CSV</i>

Menu item	Setting	Description
<i>System / Interface / Extended Oxi output</i>		The measured values for the parameters concentration (mg/l) and saturation (%) are output together. The function is active if the following requirements are met: <ul style="list-style-type: none"> ● A D.O. sensor is connected ● The D.O. sensor displays the parameter concentration (mg/l) or saturation (%) ● The <i>Output format CSV</i> is selected
<i>System / Clock function</i>	<i>Date format</i> <i>Date</i> <i>Time</i>	Settings of time and date. For details, see section 4.3.4
<i>System / Service information</i>		Hardware version and software version of the meter are displayed.
<i>System / Reset</i>	-	Resets the system settings to the default values. For details, see section 4.14.2

4.4.2 Data storage

This menu contains all functions to display, edit and erase stored measured values.



Note

Detailed information on the storage functions of the Multi 3410 is given in section 4.11.

4.4.3 Automatic Stability control

The automatic *Stability control* (AutoRead) function continuously checks the stability of the measurement signal. The stability has a considerable impact on the reproducibility of measured values.

You can activate or switch off the automatic *Stability control* function (see section 4.4).

The measured parameter flashes on the display

- as soon as the measured value is outside the stability range
- when you switch over between the measured parameters with <M>.

- when the automatic *Stability control* is switched off.

4.4.4 Automatic switch-off

The instrument has an automatic switchoff function in order to save the batteries (see section 4.4.1). The automatic switchoff switches off the measuring instrument if no key is pressed for an adjustable period.

The automatic switchoff is not active

- if the power pack is connected
- if a USB-B cable is connected
- if the *Automatic data storage* function is active, or with automatic data transmission

4.4.5 Display illumination

The meter automatically switches the display illumination to energy saving mode if no key is pressed for 20 seconds.

The illumination is switched on with the next keystroke again.

You can also generally switch on the display illumination (see section 4.4.1).

4.5 Sensor info

You can display the current sensor data and sensor settings of a connected sensor at any time. The sensor data are available in the measured value display with the [Info] softkey.

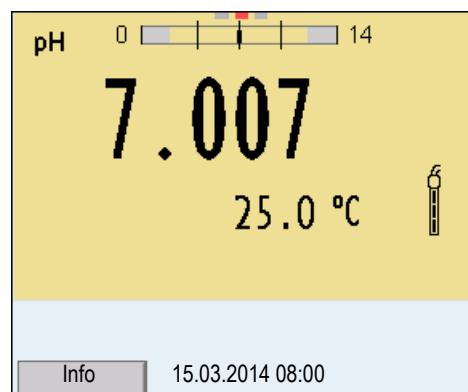

- 1 In the measured value display:
Display the sensor data (sensor name, series number) with [Info].

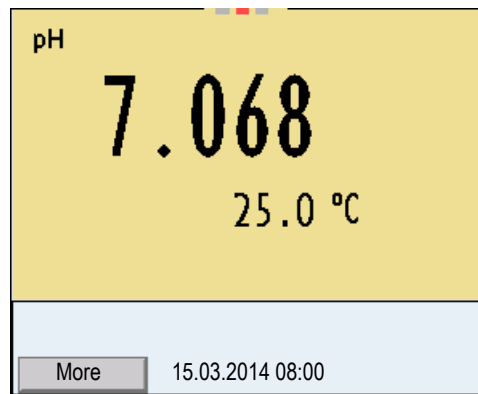

2 | Display further sensor data (settings) with [*More*].

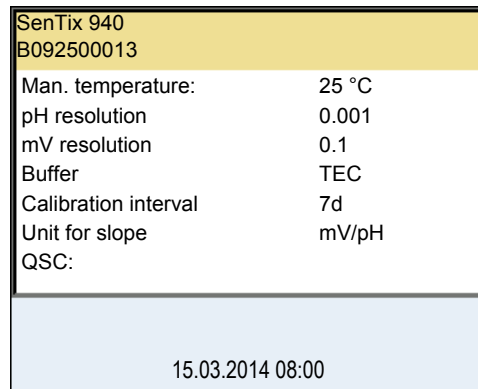

4.6 pH value

4.6.1 General information

You can measure the following parameters:

- pH value []
- Sensor voltage [mV]



Note

The sensor connection and the USB-B (device) interface are galvanically isolated. This enables interference-free measurements in grounded measuring media.

Temperature measurement

For reproducible pH measurements, it is essential to measure the temperature of the test sample. IDS sensors measure the temperature with a temperature sensor integrated in the IDS sensor.

When operating a sensor without integrated temperature sensor, e.g. via an IDS pH adapter, you have to determine and input the temperature of the measuring medium first.

Preparatory activities

Perform the following preparatory activities when you want to measure:

1	Connect the IDS pH sensor to the meter. The pH measuring window is displayed.
2	If necessary, select the measured parameter with <M> .
3	If necessary, calibrate or check the IDS pH sensor.

4.6.2 Measuring the pH value

1	Perform the preparatory activities according to section 4.6.1.
2	Immerse the IDS pH sensor in the test sample.

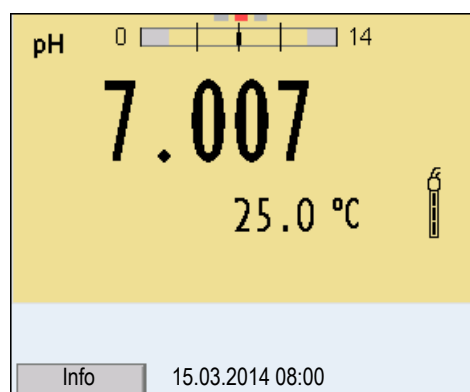

- 3 Select the pH or mV display with **<M>**.

Stability control (AutoRead)

The stability control function (AutoRead) continually checks the stability of the measurement signal. The stability has a considerable impact on the reproducibility of measured values. The display of the measured parameter flashes until a stable measured value is available.

You can start the *Stability control* manually at any time, irrespective of the setting for automatic *Stability control* (see section 4.4.3) in the *System* menu.

- 1 Freeze the measured value with **<AR>**.
The [HOLD] status indicator is displayed.
- 2 Using **<MENU/ENTER>**, activate the *Stability control* function manually.
The [AR] status indicator appears while the measured value is assessed as not stable. A progress bar is displayed and the display of the measured parameter flashes.
The [HOLD][AR] status indicator appears as soon as a stable measured value is recognized. The progress bar disappears and the display of the measured parameter stops flashing.
The current measurement data is output to the interface. Measurement data meeting the stability control criterion is marked by AR.



Note

You can prematurely terminate the *Stability control* function manually with **<MENU/ENTER>** at any time. If the *Stability control* function is prematurely terminated, the current measurement data are output to the interface without the AutoRead info.

- 3 Release the frozen measured value again with **<AR>** or **<M>**.
The [AR] status display disappears. The display switches back to the previous indication.

Criteria for a stable measured value

The *Stability control* function checks whether the measured values are stable within the monitored time interval.

Measured parameter	Time interval	Stability in the time interval
pH value	15 seconds	Δ : Better than 0.01 pH
Temperature	15 seconds	Δ : Better than 0.5 °C

The minimum duration until a measured value is assessed as stable is the monitored time interval. The actual duration is mostly longer.

4.6.3 Settings for pH measurements

Overview

The following settings are possible for pH measurements:

- Calibration record (display)
- Calibration data storage (display)
- Calibration interval
- Buffers for calibration
- Single-point calibration
- Unit for slope
- Resolution

Settings

The settings are made in the menu for calibration and measurement settings of the pH/ORP measurement. To open the settings, display the required parameter in the measured value display and press the **<MENU/ENTER>** key. After completing the settings, switch to the measured value display with **<M>**. Default settings are printed in **bold**.

Menu item	Possible setting	Description
<i>Calibration / Calibration record</i>	-	Displays the calibration record of the last calibration
<i>Calibration / Calibration data storage</i>	-	Displays the last calibration records (max. 10)
<i>Calibration / Calibration data storage / Output to USB flash drive or printer</i>	-	Outputs the calibration data storage to the interface USB-B (USB flash drive/USB printer)
<i>Calibration / Calibration data storage / Output to RS232/USB</i>	-	Outputs the calibration data storage to the interface USB-B (PC)

Menu item	Possible setting	Description
<i>Calibration / Buffer</i>	TEC NIST/DIN ConCal ...	Buffer sets to be used for pH calibration. For further buffers and details, see section 4.6.4.
<i>Calibration / Single-point calibration</i>	yes no	Quick calibration with 1 buffer
<i>Calibration / Calibration interval</i>	1 ... 7 ... 999 d	<i>Calibration interval</i> for the IDS pH sensor (in days). The meter reminds you to calibrate regularly by the flashing sensor symbol in the measuring window.
<i>Calibration / Unit for slope</i>	mV/pH %	Unit of the slope. The % display refers to the Nernst slope of -59.2 mV/pH (100 x determined slope/ Nernst slope).
<i>QSC / First calibration</i>	-	Starts the initial calibration with QSC buffers. This menu item is only available as long as no initial calibration was carried out with the connected IDS sensor.
<i>QSC / Record of first calibration</i>	-	Displays the calibration record of the QSC initial calibration
<i>QSC / Control calibration</i>	-	Starts the control calibration with QSC buffers. This menu item is only available if an initial calibration was carried out with the connected IDS sensor.
<i>Man. temperature</i>	-25 ... +25 ... +130 °C	Entry of the manually determined temperature This menu item is only available if an IDS adapter and is connected.
<i>Alternative temperature</i>	on off	Takes the measured temperature value from an IDS sensor. This menu item is only available if an IDS adapter and an IDS sensor with temperature sensor are connected.
<i>pH resolution</i>	0.001 0.01 0.1	Resolution of the pH display

Menu item	Possible setting	Description
<i>mV resolution</i>	0.1 1	Resolution of the mV display
<i>Reset</i>	-	Resets all sensor settings to the delivery condition (see section 4.14.1)

4.6.4 pH calibration

Why calibrate?

During the operation of an IDS pH sensor, the zero point (asymmetry) and slope of the sensor change with time. As a result, an inexact measured value is displayed. Calibration determines the current values of the zero point and slope of the pH sensor and stores them in the measuring instrument.

Thus, you should calibrate at regular intervals.

When do you have to calibrate?

- When the calibration interval has expired

Buffer sets for calibration

You can use the buffer sets quoted in the table for an automatic calibration. The pH values are valid for the specified temperature values. The temperature dependence of the pH values is taken into consideration during the calibration.

No.	Buffer set*	pH values	at
1	VariCal	Any	Any
2	<i>NIST/DIN</i> DIN buffers according to DIN 19266 and NIST Traceable Buffers	1.679 4.006 6.865 9.180 12.454	25 °C
3	<i>TEC</i> WTW Technical buffers	2.000 4.010 7.000 10.011	25 °C
4	<i>Merck 1*</i>	4.000 7.000 9.000	20 °C
5	<i>Merck 2*</i>	1.000 6.000 8.000 13.000	20 °C
6	<i>Merck 3*</i>	4.660 6.880 9.220	20 °C

No.	Buffer set*	pH values	at
7	<i>Merck 4 *</i>	2.000 4.000 7.000 10.000	20 °C
8	<i>Merck 5 *</i>	4.010 7.000 10.000	25 °C
9	<i>DIN 19267</i>	1.090 4.650 6.790 9.230	25 °C
10	<i>Mettler Toledo USA *</i>	1.679 4.003 7.002 10.013	25 °C
11	<i>Mettler Toledo EU *</i>	1.995 4.005 7.002 9.208	25 °C
12	<i>Fisher *</i>	2.007 4.002 7.004 10.002	25 °C
13	<i>Fluka BS *</i>	4.006 6.984 8.957	25 °C
14	<i>Radiometer *</i>	1.678 4.005 7.000 9.180	25 °C
15	<i>Baker *</i>	4.006 6.991 10.008	25 °C
16	<i>Metrohm *</i>	3.996 7.003 8.999	25 °C
17	<i>Beckman *</i>	4.005 7.005 10.013	25 °C
18	<i>Hamilton Duracal *</i>	4.005 7.002 10.013	25 °C

No.	Buffer set*	pH values	at
19	<i>Precisa</i> *	3.996 7.003 8.999	25 °C
20	<i>Reagecon TEC</i> *	2.000 4.010 7.000 10.000	25 °C
21	<i>Reagecon 20</i> *	2.000 4.000 7.000 10.000 13.000	20 °C
22	<i>Reagecon 25</i> *	2.000 4.000 7.000 10.000 13.000	25 °C
23	<i>Chemsolute</i> *	2.000 4.000 7.000 10.000	20 °C
24	<i>USABlueBook</i> *	4.000 7.000 10.000	25 °C
25	<i>YSI</i> *	4.000 7.000 10.000	25 °C

* Brand names or trade names are trademarks of their respective owners protected by law.



Note

The buffers are selected in the menu, pH / <MENU/ENTER> / Calibration / Buffer (see section 4.6.3).

Calibration points

Calibration can be performed using one to five buffer solutions in any order (single-point to five-point calibration). The meter determines the following values and calculates the calibration line as follows:

	Determined values	Displayed calibration data
1-point	Asy	<ul style="list-style-type: none"> ● Zero point = Asy ● Slope = Nernst slope (-59.2 mV/pH at 25 °C)
2-point	Asy Slp.	<ul style="list-style-type: none"> ● Zero point = Asy ● Slope = Slp.
3-point to 5-point	Asy Slp.	<ul style="list-style-type: none"> ● Zero point = Asy ● Slope = Slp. <p>The calibration line is calculated by linear regression.</p>



Stability control

Note

You can display the slope in the units, mV/pH or % (see section 4.6.3).

The calibration procedure automatically activates the stability control function. The current measurement with stability control can be terminated at any time (accepting the current value).

Calibration record

The new calibration values are displayed when a calibration procedure is completed.

Display calibration data and output to interface

You can have the data of the last calibration displayed (see section 4.6.8). Subsequently, you can transmit the displayed calibration data to the interface, e. g. to a PC, with the <PRT> key.



Sample record

Note

The calibration record is automatically transmitted to the interface after calibrating.

```
Multi 3410
Ser. no. 09250023





CALIBRATION pH
Calibration date 15.03.2014 16:13:33
SenTix 940
Ser. no. B092500013

TEC
Buffer 1          4.01
Buffer 2          7.00
Buffer 3          10.01
Voltage 1         184.0 mV   24.0 °C
Voltage 2         3.0 mV     24.0 °C
Voltage 3         -177.0 mV   24.0 °C
Slope             -60.2 mV/pH
Asymmetry         4.0 mV
Sensor            +++

etc...
```

Calibration evaluation

After calibrating, the meter automatically evaluates the calibration. The zero point and slope are evaluated separately. The worse evaluation of both is taken into account. The evaluation appears on the display and in the calibration record.

Display	Calibration record	Zero point [mV]	Slope [mV/pH]
	+++	-15 ... +15	-60.5 ... -58
	++	-20 ... +20	-58 ... -57
	+	-25 ... +25	-61 ... -60.5 or -57 ... -56
	-	-30 ... +30	-62 ... -61 or -56 ... -50
Clean the IDS sensor according to the sensor operating manual			
Error	Error	< -30 or > 30	... -62 or ... -50
Eliminate the error according to chapter 6 WHAT TO DO IF...			

**Note**

For pH IDS sensors, you can optionally enable a more finely graded calibration evaluation (QSC) (see section 4.6.10).

Preparatory activities

Perform the following preparatory activities when you want to calibrate:

1	Connect the IDS pH sensor to the meter. The pH measuring window is displayed.
2	Keep the buffer solutions ready.

4.6.5 Calibration interval

The calibration evaluation is displayed as a sensor symbol.

After the QSC function has been enabled the sensor symbol is replaced by the QSC color scale (see section 4.6.10).

After the specified calibration interval has expired, the sensor symbol

or the QSC color scale flashes. It is still possible to measure.



Note

To ensure the high measuring accuracy of the measuring system, calibrate after the calibration interval has expired.

Setting the calibration interval

The calibration interval is set to 7 days (d7) in the factory. You can change the interval (1 ... 999 days):

1	Open the menu for measurement settings with <MENU/ENTER> .
2	In the <i>Calibration / Calibration interval</i> menu, set the calibration interval with <▲><▼> .
3	Confirm the setting with <MENU/ENTER> .
4	Quit the menu with <M> .

4.6.6 Carrying out an automatic calibration (AutoCal)

Make sure that in the sensor menu, *Buffer* menu, the buffer set is correctly selected (see section 4.6.3).

Use any one to five buffer solutions of the selected buffer set in ascending or descending order.

Below, calibration with Technical buffers (*TEC*) is described. When other buffer sets are used, other nominal buffer values are displayed. Apart from that, the procedure is identical.



Note

If single-point calibration was set in the menu, the calibration procedure is automatically finished with the measurement of buffer solution 1 and the calibration record is displayed.

1	In the measured value display, select the measured parameter pH or mV with <M> .
2	Start the calibration with <CAL> . The calibration display for the first buffer appears (voltage display).

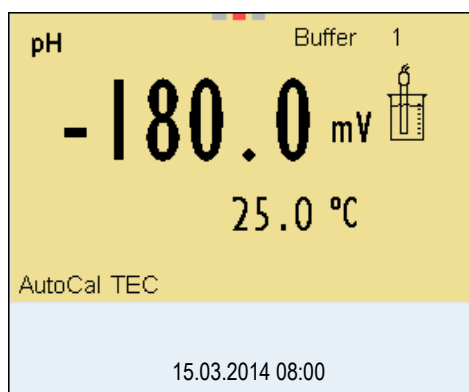

- | | |
|---|---|
| 3 | Thoroughly rinse the IDS sensor with deionized water. |
| 4 | Immerse the IDS pH sensor in buffer solution 1. |
| 5 | For measurements without temperature sensor (e.g. when using an IDS adapter): Measure the temperature of the buffer manually and enter it with <▲><▼>. |
| 6 | Start the measurement with <MENU/ENTER>. The measured value is checked for stability (stability control). The [AR] status indicator is displayed. The measured parameter flashes. |

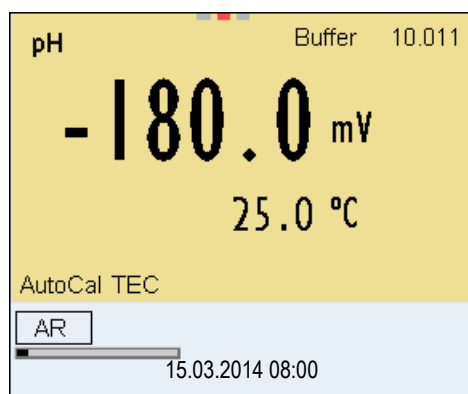

- | | |
|---|--|
| 7 | Wait for the end of the measurement with stability control or accept the calibration value with <MENU/ENTER>. The calibration display for the next buffer appears (voltage display). |
| 8 | If necessary, finish the calibration procedure as a single-point calibration with <M>. The calibration record is displayed. |

**Note**

For **single-point calibration**, the instrument uses the Nernst slope

(-59.2 mV/pH at 25 °C) and determines the zero point of the IDS pH sensor.

Continuing with two-point calibration

9	Thoroughly rinse the IDS pH sensor with deionized water.
10	Immerse the IDS pH sensor in buffer solution 2.
11	When measuring without temperature sensor: Measure the temperature of the buffer manually and enter it with <▲><▼>.
12	Start the measurement with <MENU/ENTER>. The measured value is checked for stability (stability control). The [AR] status indicator is displayed. The measured parameter flashes.

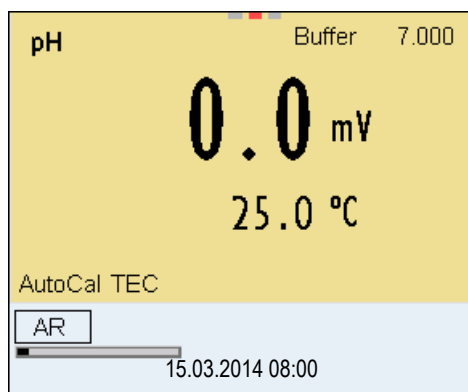

13	Wait for the measurement with stability control to be completed or terminate the stability control and take over the calibration value with <MENU/ENTER>. The calibration display for the next buffer appears (voltage display).
14	If necessary, finish the calibration procedure as a two-point calibration with <M>. The calibration record is displayed.

Continuing with three-to five-point calibration

15	Thoroughly rinse the IDS pH sensor with deionized water.
16	Immerse the IDS pH sensor in the next buffer solution.
17	When measuring without temperature sensor: Measure the temperature of the buffer manually and enter it with <▲><▼>.
18	Start the measurement with <MENU/ENTER>. The measured value is checked for stability (stability control). The [AR] status indicator is displayed. The measured parameter flashes.

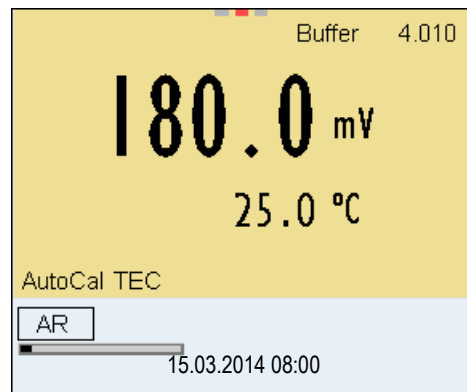

- | | |
|----|---|
| 19 | Wait for the measurement with stability control to be completed or terminate the stability control and take over the calibration value with <MENU/ENTER> .
The calibration display for the next buffer appears (voltage display). |
| 20 | If necessary, use <M> to finish the calibration.
The calibration record is displayed.
or
Switch to calibration with the next buffer with <MENU/ENTER> . |

**Note**

Calibration is automatically completed after the last buffer of a buffer set has been measured. Then the calibration record is displayed.

The calibration line is determined by linear regression.

4.6.7 Carrying out a manual calibration (ConCal)

Make sure that in the sensor menu, *Buffer* menu, the *ConCal* buffer set is correctly selected (see section 4.6.3).

Use any one to five buffer solutions in ascending or descending order.



Note

If single-point calibration was set in the menu, the calibration procedure is automatically finished with the measurement of buffer solution 1 and the calibration record is displayed.

1	In the measured value display, select the measured parameter pH or mV with <M> .
2	Start the calibration with <CAL> . The calibration display for the first buffer appears (voltage display).

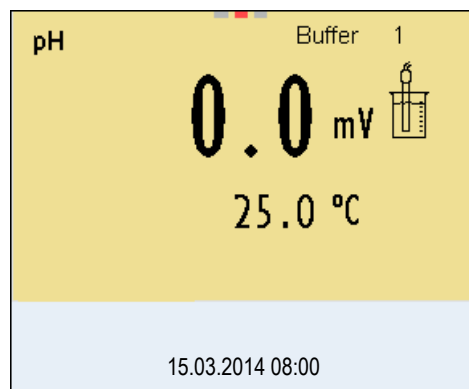

3	Thoroughly rinse the IDS sensor with deionized water.
4	Immerse the IDS pH sensor in buffer solution 1.
5	For measurements without temperature sensor (e.g. when using an IDS adapter): Measure the temperature of the buffer manually and enter it with <▲><▼> .
6	Start the measurement with <MENU/ENTER> . The measured value is checked for stability (stability control). The [AR] status indicator is displayed. The measured parameter flashes.

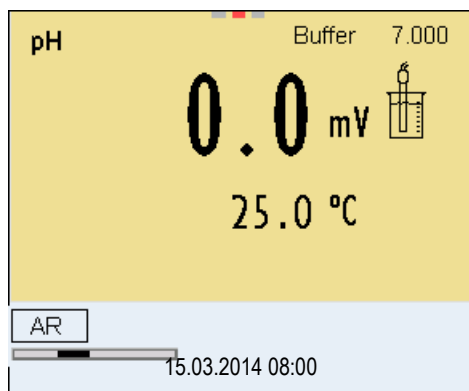

7 | Wait for the measurement with stability control to be completed or terminate the stability control and take over the calibration value with **<MENU/ENTER>**.
The pH value of the buffer solution is displayed.

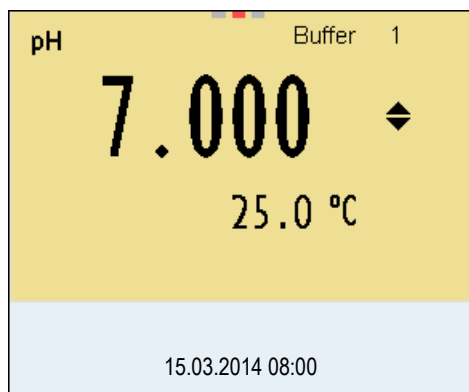

- 8 | Set the nominal buffer value for the measured temperature with **<▲><▼>**.
- 9 | Accept the calibration value with **<MENU/ENTER>**.
The calibration display for the next buffer appears (voltage display).
- 10 | If necessary, finish the calibration procedure as a single-point calibration with **<M>**.
The calibration record is displayed.



Note

For **single-point calibration**, the instrument uses the Nernst slope (-59.2 mV/pH at 25 °C) and determines the zero point of the IDS pH sensor.

Continuing with two-point calibration

11	Thoroughly rinse the IDS sensor with deionized water.
12	Immerse the IDS pH sensor in buffer solution 2.
13	When measuring without temperature sensor: Measure the temperature of the buffer manually and enter it with <▲><▼>.
14	Start the measurement with <MENU/ENTER>. The measured value is checked for stability (stability control). The [AR] status indicator is displayed. The measured parameter flashes.
15	Wait for the measurement with stability control to be completed or terminate the stability control and take over the calibration value with <MENU/ENTER>. The pH value of the buffer solution is displayed.

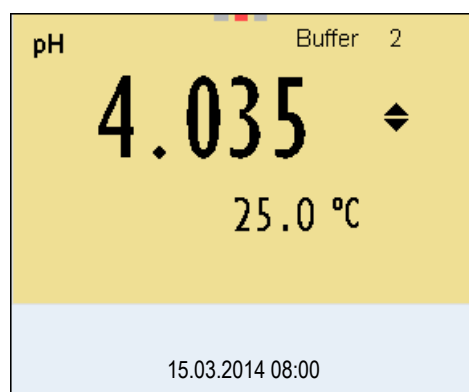

16	Set the nominal buffer value for the measured temperature with <▲><▼>.
17	Accept the calibration value with <MENU/ENTER>. The calibration display for the next buffer appears (voltage display).
18	If necessary, finish the calibration procedure as a two-point calibration with <M>. The calibration record is displayed.

Continuing with three- to five-point calibration

19	Thoroughly rinse the IDS pH sensor with deionized water.
20	Immerse the IDS pH sensor in the next buffer solution.
21	When measuring without temperature sensor: Measure the temperature of the buffer manually and enter it with <▲><▼>.
22	Start the measurement with <MENU/ENTER>. The measured value is checked for stability (stability control). The [AR] status indicator is displayed. The measured parameter flashes.
23	Wait for the measurement with stability control to be completed or terminate the stability control and take over the calibration value with <MENU/ENTER>. The pH value of the buffer solution is displayed.

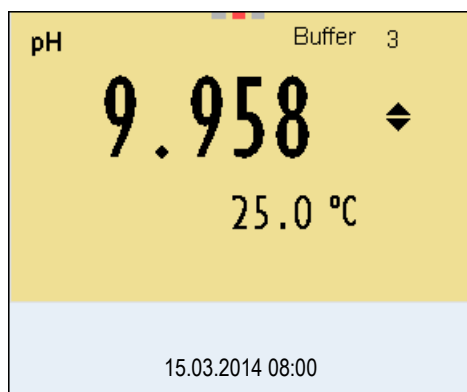

24	Set the nominal buffer value for the measured temperature with <▲><▼>.
25	Accept the calibration value with <MENU/ENTER>. The calibration display for the next buffer appears (voltage display).
26	If necessary, use <M> to finish the calibration. The calibration record is displayed. or Continue calibrating using the next buffer with <MENU/ENTER>.



Note

After the fifth buffer has been measured the calibration is automatically finished. Then the calibration record is displayed.
The calibration line is determined by linear regression.

Displaying the calibration record

4.6.8 Displaying calibration records

The calibration data can be displayed and then output to the interface.

The calibration record of the last calibration is to be found under the menu item, *Calibration / Calibration record*. To open it in the measured value display, press the **<CAL __>** key.

The calibration records of the last 10 calibrations are to be found in the menu, *Calibration / Calibration data storage / Display*. To open the *Calibration* menu, press the **<MENU/ENTER>** key in the measured value display.

Menu item	Setting/function	Description
<i>Calibration / Calibration data storage / Display</i>	-	Displays the calibration records. Further options: <ul style="list-style-type: none"> ● Scroll through the calibration records with <<>>>. ● Output the displayed calibration record to the interface with <PRT>. ● Output all calibration records to the interface with <PRT __>. ● Quit the display with <ESC>. ● Switch directly to the measured value display with <M>.
<i>Calibration / Calibration data storage / Output to USB flash drive or printer</i>	-	Outputs the calibration data storage to the interface USB-B (USB flash drive/USB printer)
<i>Calibration / Calibration data storage / Output to RS232/USB</i>	-	Outputs the calibration data storage to the interface USB-B (PC)

4.6.9 Continuous measurement control (CMC function)

The Continuous Measurement Control (CMC function) facilitates to evaluate the current measured value instantly and definitely.

After each successful calibration the scale of the pH measuring range is displayed in the measured value display. Here you can very clearly see whether or not the current measured value is in the calibrated part of the measuring range.

The following information is displayed:

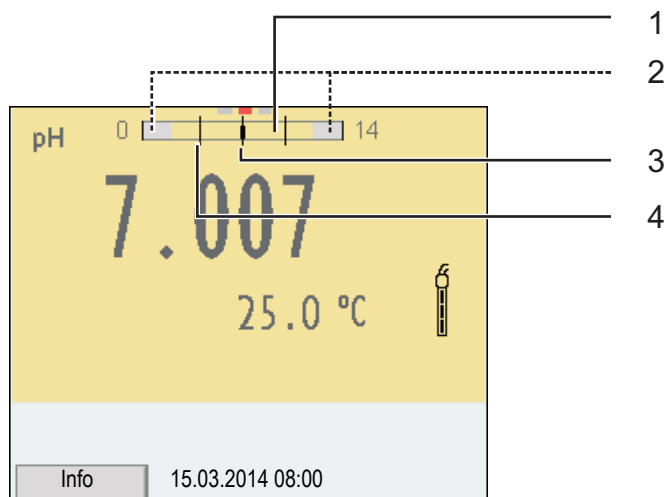

1	Measuring range for which a valid calibration is available (background color). Measured values in this range are suitable for documentation.
2	Measuring range for which no valid calibration is available (light gray). Measured values in this range are not suitable for documentation. Calibrate the meter with buffers covering this measuring range. If the current measured value is not in the calibrated range, the color of this range changes to dark gray. If a measured value is outside the measuring range pH 0 - 14, overflow arrows are displayed at the left or right edge of the measuring range.
3	Currently measured pH value (needle)
4	Marking lines for all nominal buffer values used with the last valid calibration

The limits of the calibrated range are determined by the buffers used for calibration:

Lower limit:	Buffer with lowest pH value - 2 pH units
Upper limit:	Buffer with highest pH value + 2 pH units

General information on the QSC function

4.6.10 QSC function (sensor quality control)

The QSC function (Quality Sensor Control) is a new sensor evaluation for digital IDS sensors. It evaluates the condition of an IDS pH sensor individually and with a very fine grading.

On the display, the QSC color scale (from green to yellow) indicates the current sensor evaluation by means of a pointer.

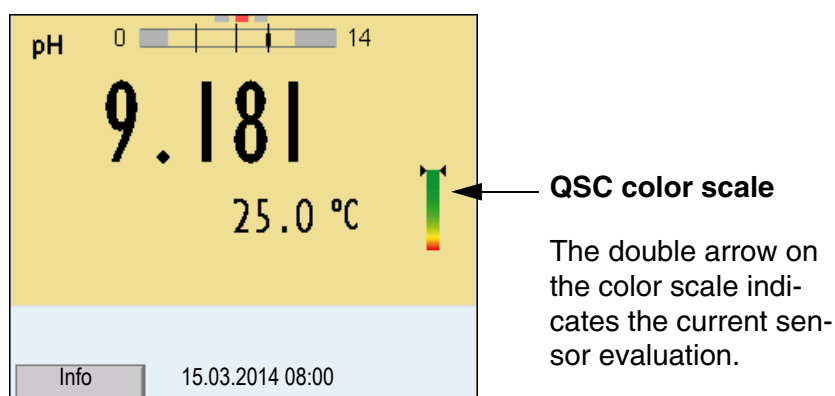

QSC color scale

The double arrow on the color scale indicates the current sensor evaluation.

In the printout, the sensor evaluation is quoted as a percentage (1-100).

The finely graded sensor evaluation of the QSC function promptly calls your attention to changes of the sensor.

Thus you can do what is necessary to restore the optimum measuring quality (e.g. clean, calibrate or replace the sensor).

Sensor evaluation with / without QSC function

With QSC function	Without QSC function (sensor symbol)
Very fine grading of the sensor evaluation (100 grades)	Rough grading of the sensor evaluation (4 grades)
The reference value is individually determined for each sensor during the QSC initial calibration.	A theoretical reference value is used for all sensors
Low tolerances for zero point and slope when using QSC buffer solutions	Greater tolerances for zero point and slope when using commercial buffer sets
Additional QSC calibration required (with special QSC buffer set)	No additional calibration required

QSC calibration

The QSC function is enabled by once carrying out an additional three-point calibration with special QSC buffer solutions. It covers the measuring range of the sensor from pH 2 to pH 11. The QSC initial calibration determines the actual condition of the sensor and stores it as a reference in the sensor.

To meet the high requirements of a QSC initial calibration, the QSC initial calibration should optimally be carried out with the initial commissioning of the sensor.

Carry out the normal calibrations for your special measuring range with your usual standard solutions as previously done.



Note

As soon as the QSC function was enabled for an IDS sensor, it is not possible to return to the sensor evaluation with the sensor symbol for this sensor.

Carrying out a QSC initial calibration

- | | |
|---|---|
| 1 | Open the menu for measurement settings with <MENU/ENTER> . |
| 2 | In the <i>QSC</i> menu, select <i>First calibration</i> with <▲><▼> . The calibration display appears. AutoCal QSC-Kit is displayed as the buffer.
Exclusively use the QSC-Kit for the QSC calibration. If you use other buffers, you will have no valid QSC calibration. |

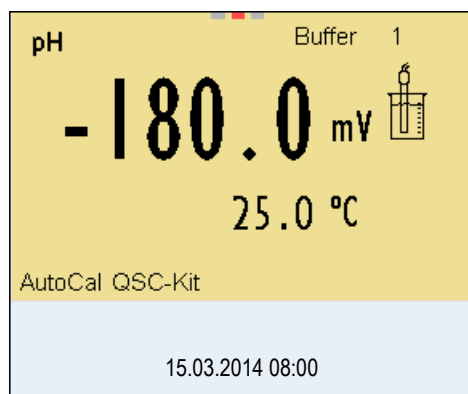

- | | |
|---|---|
| 3 | Calibration with the buffers of the QSC-Kit is done like a normal three-point calibration. Follow the user guide. |
|---|---|



Note

Carry out the QSC initial calibration very carefully. It determines the reference value for the sensor. This reference value cannot be overwritten or reset.

As soon as the QSC function was enabled, it is not possible to return to

the sensor evaluation with the sensor symbol.

- | | |
|---|--|
| 4 | As soon as the three-point calibration has been successfully carried out you can decide whether to accept or discard the calibration as the QSC initial calibration. |
|---|--|

The QSC initial calibration is completed. The sensor is calibrated. If you want to calibrate with special buffers for your measurements, you can subsequently carry out a normal calibration with your buffers. The reference values determined with the QSC calibration are also used for the evaluation of normal calibrations. In the measured value display, the color scale of the QSC function is always displayed. A double arrow on the color scale indicates the current sensor evaluation.

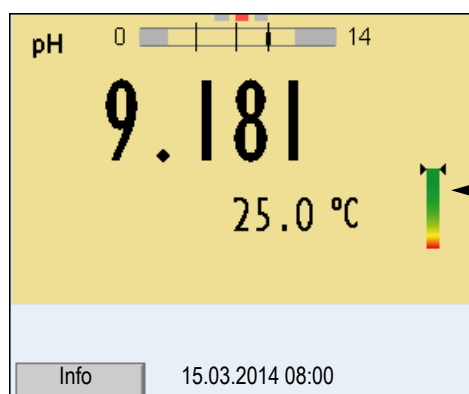

QSC color scale

The double arrow on the color scale indicates the current sensor evaluation.

You can carry out QSC control calibrations at greater intervals than normal calibrations.

A QSC control calibration can, e.g. be useful if the sensor evaluation noticeably changed (after some normal calibrations).

Carrying out a QSC control calibration

- | | |
|---|--|
| 1 | Open the menu for measurement settings with <MENU/ENTER> . |
| 2 | In the QSC menu, select <i>Control calibration</i> with <▲><▼> . The calibration display appears. AutoCal QSC-Kit is displayed as the buffer.
Exclusively use the QSC-Kit for the QSC calibration. If you use other buffers, you will have no valid QSC control calibration. |
| 3 | Follow the user guide.
The calibration is carried out like a normal three-point calibration. As soon as the three-point calibration has been successfully carried out you can decide whether to accept or discard the calibration as the QSC control calibration. |

4.7 ORP voltage

4.7.1 General information

You can measure the following parameters:

- ORP [mV]



Note

The sensor connection and the USB-B (device) interface are galvanically isolated. This enables interference-free measurements in grounded measuring media.

Preparatory activities

Perform the following preparatory activities when you want to measure:

- | | |
|---|--|
| 1 | Connect the IDS ORP sensor to the meter.
The ORP measuring window is displayed. |
| 2 | Check the meter with the IDS ORP sensor. |

4.7.2 Measuring the ORP



Note

IDS ORP sensors are not calibrated. However, you can check IDS ORP sensors using a test solution.

- | | |
|---|--|
| 1 | Perform the preparatory activities according to section 4.6.1. |
| 2 | Immerse the IDS ORP sensor in the test sample. |

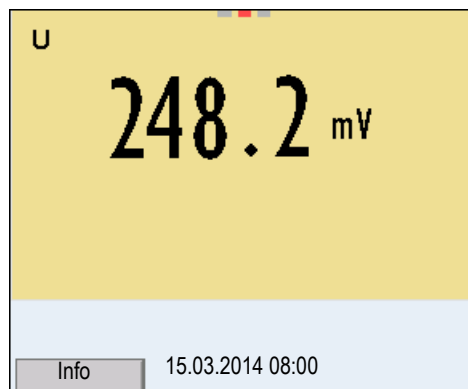

- | | |
|---|---------------------------------|
| 3 | Select the mV display with <M>. |
|---|---------------------------------|

Stability control (AutoRead)

The stability control function (AutoRead) continually checks the stability of the measurement signal. The stability has a considerable impact on the reproducibility of measured values. The display of the measured parameter flashes until a stable measured value is available.

You can start the *Stability control* manually at any time, irrespective of the setting for automatic *Stability control* (see section 4.4.3) in the *System* menu.

1	Freeze the measured value with <AR> . The [HOLD] status indicator is displayed.
2	Using <MENU/ENTER> , activate the <i>Stability control</i> function manually. The [AR] status indicator appears while the measured value is assessed as not stable. A progress bar is displayed and the display of the measured parameter flashes. The [HOLD][AR] status indicator appears as soon as a stable measured value is recognized. The progress bar disappears and the display of the measured parameter stops flashing. The current measurement data is output to the interface. Measurement data meeting the stability control criterion is marked by AR.



Note

You can prematurely terminate the *Stability control* function manually with **<MENU/ENTER>** at any time. If the *Stability control* function is prematurely terminated, the current measurement data are output to the interface without the AutoRead info.

3	Release the frozen measured value again with <AR> or <M> . The [AR] status display disappears. The display switches back to the previous indication.
---	---

Criteria for a stable measured value

The *Stability control* function checks whether the measured values are stable within the monitored time interval.

Measured parameter	Time interval	Stability in the time interval
ORP voltage	15 seconds	Δ : Better than 0.3 mV
Temperature	15 seconds	Δ : Better than 0.5 °C

The minimum duration until a measured value is assessed as stable is the monitored time interval. The actual duration is mostly longer.

4.7.3 Settings for ORP measurements

Overview The following settings are possible for ORP measurements:

- Resolution
- Automatic stability control

Settings The settings are made in the menu for measuring settings of the ORP measurement. To open the settings, display the required parameter in the measured value display and press the **<MENU/ENTER>** key. After completing the settings, switch to the measured value display with **<M>**.

Default settings are printed in **bold**.

Menu item	Possible setting	Description
<i>mV resolution</i>	0.1 1	Resolution of the mV display
<i>Reset</i>	-	Resets all sensor settings to the delivery condition (see section 4.14.1)

4.8 Dissolved oxygen

4.8.1 General information

You can measure the following parameters:

- D.O. concentration
- D.O. saturation index ("D.O. saturation")
- D.O. partial pressure



Note

The sensor connection and the USB-B (device) interface are galvanically isolated. This enables interference-free measurements in grounded measuring media.

Temperature measurement

Preparatory activities

IDS D.O. sensors measure the temperature with a temperature sensor integrated in the IDS sensor.

Perform the following preparatory activities when you want to measure:

1	Connect the D.O. sensor to the meter. The D.O. measuring window is displayed.
2	Check or calibrate the meter with the sensor.



Note

The FDO[®] 925 needs to be calibrated in special cases only. Regular FDO[®] Checks are sufficient.

4.8.2 Measuring

- 1 Perform the preparatory activities according to section 4.9.1.
- 2 Immerse the D.O. sensor in the test sample.

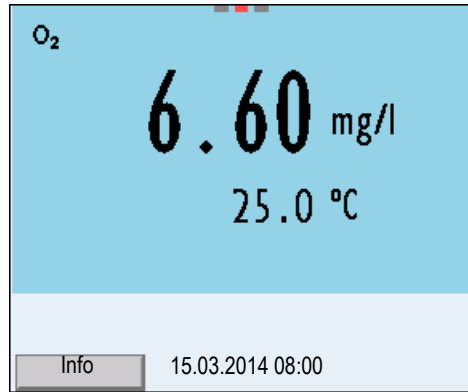

Selecting the displayed measured parameter

You can switch between the following displays with **<M>**:

- D.O. concentration [mg/l]
- D.O. saturation [%]
- D.O. partial pressure [mbar].

Salinity correction

When measuring the concentration of solutions with a salt content of more than 1 g/l, a salinity correction is required. For this, you have to measure and input the salinity of the measured medium first.

When the salinity correction is switched on, the **[SAL]** indicator is displayed in the measuring window.

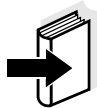

Note

You can switch the salinity correction on or off and enter the salinity in the menu for calibration and measurement settings (see section 4.9.4).

Freezing the measured value (HOLD function)

With the HOLD function, you can freeze the current measured value. The displayed measured value stops changing until you switch the HOLD function off.

- 1 Freeze the measured value with **<AR>**.
The **[HOLD]** status indicator is displayed.



Note

If the HOLD function is active, you can, e.g. start a manual measurement with stability control.

- 2 Release the frozen measured value again with **<AR>**.
The HOLD function is switched off.
The **[HOLD]** status display disappears.

Stability control (AutoRead)

The stability control function (AutoRead) continually checks the stability of the measurement signal. The stability has a considerable impact on the reproducibility of measured values. The display of the measured parameter flashes until a stable measured value is available.

You can start a measurement with *Stability control* manually at any time, irrespective of the setting for automatic *Stability control* (see section 4.4.3) in the *System* menu.

1	Freeze the measured value with <AR> . The [HOLD] status indicator is displayed.
2	Using <MENU/ENTER> , activate the <i>Stability control</i> function manually. The [AR] status indicator appears while the measured value is assessed as not stable. A progress bar is displayed and the display of the measured parameter flashes. The [HOLD][AR] status indicator appears as soon as a stable measured value is recognized. The progress bar disappears and the display of the measured parameter stops flashing. The current measurement data is output to the interface. Measurement data meeting the stability control criterion is marked by AR.



Note

You can prematurely terminate the *Stability control* function manually with **<MENU/ENTER>** at any time. If the *Stability control* function is prematurely terminated, the current measurement data are not output to the interface.

3	Using <MENU/ENTER> , start a further measurement with <i>Stability control</i> . or Release the frozen measured value again with <AR> . The display switches to the measured value display. The [AR][HOLD] status display disappears.
---	---

Criteria for a stable measured value

The *Stability control* function checks whether the measured values are stable within the monitored time interval.

Measured parameter	Time interval	Stability in the time interval
D.O. concentration	20 seconds	Δ : Better than 0.03 mg/l
D.O. saturation	20 seconds	Δ : Better than 0.4 %
D.O. partial pressure	20 seconds	Δ : Better than 0.8 mbar
Temperature	15 seconds	Δ : Better than 0.5 °C

The minimum duration until a measured value is assessed as stable is the monitored time interval. The actual duration is mostly longer.

4.8.3 Settings for D.O. sensors (menu or measurement and calibration settings)

Overview

The following settings are possible for D.O. sensors:

- Calibration record (display)
- Calibration data storage (display)
- Calibration interval
- FDO Check
- Check interval
- Salinity correction
- Salinity (salinity equivalent)

Settings

The settings are available in the menu for measurement and calibration settings. To open the settings, display the required parameter in the measured value display and press the **<MENU/ENTER>** key. After completing the settings, switch to the measured value display with **<M>**.

Menu item	Possible setting	Description
<i>Calibration / Calibration record</i>	-	Displays the calibration record of the last calibration
<i>Calibration / Calibration data storage</i>	-	Displays the last calibration records (max. 10)

Menu item	Possible setting	Description
<i>Calibration / Calibration data storage / Output to USB flash drive or printer</i>	-	Outputs the calibration data storage to a connected USB flash drive/USB printer
<i>Calibration / Calibration data storage / Output to RS232/USB</i>	-	Outputs the calibration data storage to the interface
<i>Calibration / Calibration interval</i>	1 ... 180 ... 999 d	<i>Calibration interval</i> for the D.O. sensor (in days). The meter reminds you to calibrate regularly by the flashing sensor symbol in the measuring window.
<i>FDO Check / Start FDO Check</i>	-	Starts the FDO [®] Check.
<i>FDO Check / Check interval</i>	1 ... 60 ... 999 d	Interval for the <i>FDO Check</i> (in days). The <i>FDO Check</i> status display indicator in the measuring window reminds you to check the sensor regularly.
<i>Sal correction</i>	<i>on</i> <i>off</i>	Manual salt content correction for concentration measurements
<i>Salinity</i>	0.0 ... 70.0	Salinity or salinity equivalent for the salt content correction. This function is only available for concentration measurements if the manual salt content correction is switched on.

Menu item	Possible setting	Description
<i>Response time t90</i>	30 ... 300	<p>Response time of the signal filter (in seconds).</p> <p>A signal filter in the sensor reduces the fluctuation range of the measured value. The signal filter is characterized by the response time t90. This is the time after which 90 % of a signal change is displayed.</p> <p>This menu item is only available if sensor and meter support this function.</p> <p>Firmware updates for the IDS sensor and the meter are provided on the internet (see chapter 9).</p>
<i>Reset</i>	-	Resets all sensor settings to the delivery condition (see section 4.14.1)

4.8.4 FDO[®] Check procedure (check of the FDO[®] 925)

Why should you check the sensor?

With the FDO[®] Check procedure, you can find out in a simple manner whether the FDO[®] 925 D.O. sensor should be cleaned or calibrated.

When should you check the sensor?

Checking can be useful in the following cases:

- When the check interval has expired
- If the measured values seem to be implausible
- If you assume that the sensor cap is contaminated or at the end of its lifetime
- After the sensor cap was exchanged
- Routinely within the scope of company quality assurance measures.

FDO[®] Check procedure

Check in water vapor-saturated air.

Use the check and storage vessel to carry out the FDO[®] Check procedure.

Stability control (AutoRead)

The Stability control function (AutoRead) is automatically activated for the FDO[®] Check.

Carrying out the FDO[®] Check procedure

Proceed as follows to carry out the FDO[®] Check procedure:

1	Connect the D.O. sensor to the meter.
2	Place the D.O. sensor in the check and storage vessel.



Note

The sponge in the check and storage vessel must be moist (not wet). Leave the sensor in the check and storage vessel long enough so it can adapt to the ambient temperature.

3	In the measuring menu, start the FDO [®] Check procedure with <i>FDO Check / Start FDO Check</i> . The meter switches to the measured parameter, %.
---	---

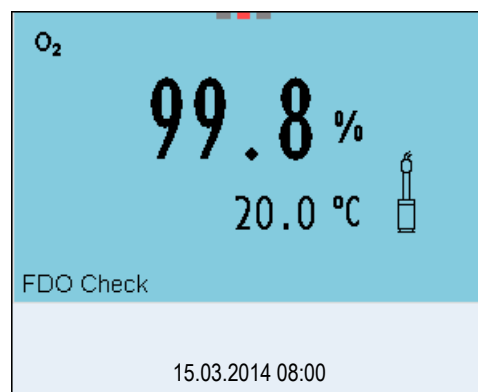

4	Start the measurement with <MENU/ENTER> . The measured value is checked for stability (stability control). The [AR] status indicator is displayed. The measured parameter flashes.
5	Wait for the AutoRead measurement to be completed ([HOLD][AR]) display or accept the measured value with <MENU/ENTER> . The measured value is frozen.
6	Switch to the measured value display with <M> . The check measurement is not documented.

Evaluation

The evaluation is based on the accuracy required by the user. Together with the nominal value (100 %), this results in a validity scope for the check.

If the measured value is within the validity scope, no cleaning or user calibration is required.

If the measured value is outside the validity scope, the sensor shaft and membrane should be cleaned, and the check should then be repeated.

Example:

- Required accuracy: ± 2 %.
- In water vapor-saturated air or air-saturated water, the nominal value for the relative D.O. saturation (abbreviated: saturation) is 100 %.
- Therefore, the validity scope is 98 ... 102 %
- The check resulted in a measured value of 99,3 %

The measurement error is within the specified validity scope.
No cleaning or user calibration is required.

4.8.5 D.O. calibration

Why calibrate?

D.O. sensors age. This changes the slope of the D.O. sensor. Calibration determines the current slope of the sensor and stores this value in the instrument.



Note

The FDO[®] 925 D.O. sensor ages so little it does not have to be regularly calibrated.

To detect changes of the sensor as early as possible, the FDO[®] Check procedure can be useful (see section 4.8.4).

When to calibrate?

- If your evaluation of the FDO[®] Check procedure suggests a calibration
- When the calibration interval has expired
- If your accuracy requirements are especially high
- Routinely within the scope of company quality assurance measures.

Calibration procedures

Calibration in water vapor-saturated air.
To calibrate the FDO[®] 925 sensor, use the check and storage vessel.

Stability control (AutoRead)

In calibration, the Stability control function (AutoRead) is automatically activated.

Display calibration data and output to interface

You can have the data of the last calibration displayed (see section 4.9.6). Subsequently, you can transmit the displayed calibration data to the interface, e. g. to a PC, with the <PRT> key.



Note

The calibration record is automatically transmitted to the interface after calibrating.

Sample record

```
Multi 3410
Ser. no. 10139695



CALIBRATION Ox
Calibration date 15.03.2014 16:13:33
FDO 925
Ser. no. 10146858

SC-FDO 925      10158765
Relative slope  0.98
Sensor          +++
```

Calibration evaluation

After the calibration, the meter automatically evaluates the current status of the calibration. The evaluation appears on the display and in the calibration record.

Calibration evaluation of the FDO[®] 925

Display	Calibration record	Relative slope
	+++	S = 0.94 ... 1.06
	++	S = 0.92 ... 0.94 or S = 1.06 ... 1.08
	+	S = 0.90 ... 0.92 or S = 1.08 ... 1.10
Error	Error	S < 0.90 or S > 1.10

Eliminate the error according to chapter 6 WHAT TO DO IF...

Calibration in water vapor-saturated air

Proceed as follows to calibrate the D.O. sensor:

- 1 Connect the D.O. sensor to the meter.
- 2 Place the FDO[®] 925 D.O. sensor into the check and storage vessel.



Note

The sponge in the check and storage vessel must be moist (not wet). Leave the sensor in the check and storage vessel long enough so it can adapt to the ambient temperature.

- 3 Start the calibration with **<CAL>**. The last calibration data (relative slope) is displayed.

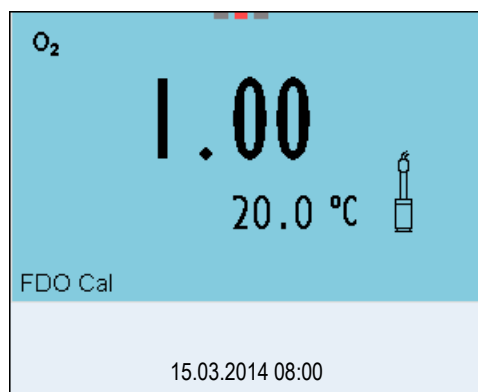

4	Start the measurement with <MENU/ENTER> . The measured value is checked for stability (stability control). The [AR] status indicator is displayed. The measured parameter flashes.
5	Wait for the AutoRead measurement to be completed ([HOLD][AR]) display or accept the calibration value with <MENU/ENTER> . The calibration record is displayed and output to the interface.
6	Switch to the measured value display with <MENU/ENTER> .

Displaying the calibration record

4.8.6 Displaying calibration records

The calibration data can be displayed and then output to the interface.

The calibration record of the last calibration is available under the menu item, *Calibration / Calibration record*. To open it in the measured value display, press the **<CAL__>** key.

The calibration records of the last 10 calibrations are available in the menu, *Calibration / Calibration data storage / Display*. To open the *Calibration* menu, press the **<MENU/ENTER__>** key in the measured value display.

Menu item	Setting/function	Description
<i>Calibration / Calibration data storage / Display</i>	-	Displays the calibration records. Further options: <ul style="list-style-type: none"> ● Scroll through the calibration records with <◀><▶>. ● Output the displayed calibration record to the interface with <PRT>. ● Output all calibration records to the interface with <PRT__>. ● Quit the display with <ESC>. ● Switch directly to the measured value display with <M>.
<i>Calibration / Calibration data storage / Output to USB flash drive or printer</i>	-	Outputs the calibration data storage to the interface USB-B (USB flash drive/USB printer)
<i>Calibration / Calibration data storage / Output to RS232/USB</i>	-	Outputs the calibration data storage to the interface USB-B (PC)

4.9 Conductivity

4.9.1 General information

You can measure the following parameters:

- Conductivity
- Specific resistance
- Salinity
- Total dissolved solids (TDS)



Note

The sensor connection and the USB-B (device) interface are galvanically isolated. This enables interference-free measurements in grounded measuring media.

Temperature measurement Preparatory activities

IDS sensors measure the temperature with a temperature sensor integrated in the IDS sensor.

Perform the following preparatory activities when you want to measure:

- | | |
|---|--|
| 1 | Connect an IDS conductivity sensor to the meter. The conductivity measuring window is displayed. The <i>Measuring cell</i> and cell constant for the connected IDS conductivity sensor are automatically taken over. |
|---|--|

4.9.2 Measuring

You can carry out conductivity measurements as follows:

- | | |
|---|--|
| 1 | Perform the preparatory activities according to section 4.9.1. |
| 2 | Immerse the IDS conductivity sensor in the test sample. |

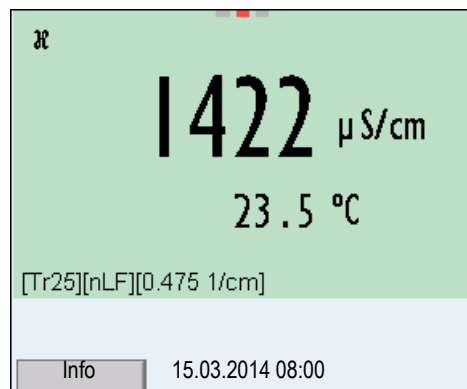

Selecting the displayed measured parameter

You can switch between the following displays with **<M>**:

- Conductivity [$\mu\text{S}/\text{cm}$] / [mS/cm]
- Resistivity [$\Omega\cdot\text{cm}$] / [$\text{k}\Omega\cdot\text{cm}$] / [$\text{M}\Omega\cdot\text{cm}$]
- Salinity SaL []
- Total dissolved solids TDS [mg/l] / [g/l]

The factor to calculate the total dissolved solids is set to 1.00 in the factory. You can adjust this factor to meet your requirements in the range of 0.40 to 1.00. The factor is set in the menu for the parameter, TDS.

Freezing the measured value (HOLD function)

With the HOLD function, you can freeze the current measured value. The displayed measured value stops changing until you switch the HOLD function off.

- | | |
|---|---|
| 1 | Freeze the measured value with <AR> .
The [HOLD] status indicator is displayed. |
|---|---|



Note

If the HOLD function is active, you can, e.g. start a manual measurement with stability control.

- | | |
|---|---|
| 2 | Release the frozen measured value again with <AR> .
The HOLD function is switched off.
The [HOLD] status display disappears. |
|---|---|

Stability control (AutoRead)

The stability control function (AutoRead) continually checks the stability of the measurement signal. The stability has a considerable impact on the reproducibility of measured values. The display of the measured parameter flashes until a stable measured value is available.

You can start the *Stability control* function manually at any time, irrespective of the setting for automatic *Stability control* (see section 4.4.3) in the *System* menu.

- | | |
|---|---|
| 1 | Freeze the measured value with <AR> .
The [HOLD] status indicator is displayed. |
| 2 | Using <MENU/ENTER> , activate the <i>Stability control</i> function manually.
The [AR] status indicator appears while the measured value is assessed as not stable. A progress bar is displayed and the display of the measured parameter flashes.
The [HOLD][AR] status indicator appears as soon as a stable measured value is recognized. The progress bar disappears and the display of the measured parameter stops flashing.
The current measurement data is output to the interface. Measurement data meeting the stability control criterion is marked by AR. |

**Note**

You can prematurely terminate the *Stability control* function manually with **<MENU/ENTER>** at any time. If the *Stability control* function is prematurely terminated, the current measurement data are output to the interface without the AutoRead info.

- 3 Using **<MENU/ENTER>**, start a further measurement with *Stability control*.
or
Release the frozen measured value again with **<AR>**.
The display switches to the measured value display.
The [AR][HOLD] status display disappears.

Criteria for a stable measured value

The *Stability control* function checks whether the measured values are stable within the monitored time interval.

Measured parameter	Time interval	Stability in the time interval
Conductivity χ	10 seconds	Δ : Better than 1.0% of measured value
Temperature	10 seconds	Δ : Better than 0.5 °C

The minimum duration until a measured value is assessed as stable is the monitored time interval. The actual duration is mostly longer.

4.9.3 Temperature compensation

The calculation of the temperature compensation is based on the pre-set reference temperature, 20 °C or 25 °C. It appears on the display as *Tr20* or *Tr25*.

You can select one of the following temperature compensation methods:

- **Nonlinear temperature compensation (*nLF*)** according to EN 27 888
- **Linear temperature compensation (*Lin*)** with adjustable coefficients of 0.000 ... 10.000 %/K
- No temperature compensation (off)



Note

The reference temperature and temperature compensation are set in the menu for the parameter, conductivity (see section 4.9.4).

Application tips

Select the following temperature compensations given in the table according to the respective test sample:

Test sample	Temperature compensation	Display indicator
Natural water (ground water, surface water, drinking water)	<i>nLF</i> according to EN 27 888	<i>nLF</i>
Ultrapure water	<i>nLF</i> according to EN 27 888	<i>nLF</i>
Other aqueous solutions	<i>lin</i> Set linear temperature coefficient 0.001 ... 10.000 %/K	<i>lin</i>
Salinity (seawater)	Automatic <i>nLF</i> according to IOT (International Oceanographic Tables)	Sal, <i>nLF</i>

4.9.4 Settings for IDS conductivity sensors

Overview

The following settings are possible for IDS conductivity sensors:

- Calibration record (display)
- Calibration data storage (display)
- Calibration interval
- Reference temperature
- Temperature compensation
- TDS factor
- Unit of the temperature

Settings

The settings are made in the menu for the measured parameter, conductivity. To open the settings, display the required parameter in the measured value display and press the **<MENU/ENTER>** key. After completing the settings, switch to the measured value display with **<M>**.

The possible settings are individually displayed for each sensor. Below the setting menu is displayed for two IDS sensors (TetraCon 925, LR 925/01).

Default settings are printed in **bold**.

Setting menu of TetraCon 925

Menu item	Possible setting	Description
<i>Calibration / Calibration record</i>	-	Displays the calibration record of the last calibration
<i>Calibration / Calibration data storage</i>	-	Displays the last calibration records (max. 10)
<i>Calibration / Calibration data storage / Output to USB flash drive or printer</i>	-	Outputs the calibration data storage to a connected USB flash drive/USB printer
<i>Calibration / Calibration interval</i>	1 ... 150 ... 999 d	<i>Calibration interval</i> for the IDS conductivity sensor (in days). The meter reminds you to calibrate regularly by the flashing sensor symbol in the measuring window.

Menu item	Possible setting	Description
<i>Type</i>	<i>Cal</i> <i>man</i>	Measuring cell used Measuring cells whose cell constant is determined by calibration in the KCL control standard solution. Calibration range: 0.450 to 0.500 cm ⁻¹ The currently valid cell constant is displayed in the status line. Freely adjustable cell constant in the range 0.450 ... 0.500 cm ⁻¹ .
<i>Man. cell const.</i>	0.450 ... 0.475 ... 0.500 cm ⁻¹	The cell constant can be displayed and set here
<i>Temp. comp. (TC) / Method</i>	nLF <i>Lin</i> <i>off</i>	Procedure for temperature compensation (see section 4.9.3). This setting is only available for the measured parameters, α and ρ .
<i>Temp. comp. (TC) / Linear coeff.</i>	0.000 ... 2.000 ... 10.000 %/K	Coefficient of the linear temperature compensation. This setting is only available when the linear temperature compensation is set.
<i>Temp. comp. (TC) / Reference temp.</i>	20 °C 25 °C	Reference temperature This setting is only available for the measured parameters, α and ρ .
<i>TDS factor</i>	0.40 ... 1.00	Factor for TDS value
<i>Reset</i>	-	Resets all sensor settings to the delivery condition (see section 4.14.1)

Setting menu of LR 925/01	Menu item	Possible setting	Description
	<i>Cell constant</i>	0.090 0.100 ... 0.110 cm ⁻¹	The cell constant can be displayed and set here
	<i>Temp. comp. (TC) / Method</i>	nLF Lin off	Procedure for temperature compensation (see section 4.9.3). This setting is only available for the measured parameters, χ and ρ .
	<i>Temp. comp. (TC) / Linear coeff.</i>	0.000 ... 2.000 ... 10.000 %/K	Coefficient of the linear temperature compensation. This setting is only available when the linear temperature compensation is set.
	<i>Temp. comp. (TC) / Reference temp.</i>	20 °C 25 °C	Reference temperature This setting is only available for the measured parameters, χ and ρ .
	<i>TDS factor</i>	0.40 ... 1.00	Factor for TDS value
	<i>Reset</i>	-	Resets all sensor settings to the delivery condition (see section 4.14.1)

4.9.5 Determining the cell constant (calibration in control standard)

Why determine the cell constant?

Aging slightly changes the cell constant, e. g. due to coatings. As a result, an inexact measured value is displayed. The original characteristics of the cell can often be restored by cleaning the cell. Calibration determines the current value of the cell constant and stores this value in the meter. Thus, you should calibrate at regular intervals (we recommend: every 6 months).

Procedure

You can determine the actual cell constant of the IDS conductivity sensor cell by calibrating with the control standard in the following range:

- 0.450 ... 0.500 cm⁻¹
(e.g. TetraCon 925, nominal cell constant 0.475)

The cell constant is determined in the control standard, 0.01 mol/l KCl. In the delivery condition, the calibrated cell constant of the IDS sensor is set to 0.475 cm⁻¹ (conductivity measuring cell, TetraCon 925).

Stability control (AutoRead)

In calibration, the Stability control function (AutoRead) is automatically activated.

Display calibration data and output to interface

You can have the data of the last calibration displayed (see section 4.9.6). Subsequently, you can transmit the displayed calibration data to the interface, e. g. to a PC, with the <PRT> key.



Note

The calibration record is automatically transmitted to the interface after calibrating.

Sample record

```
Multi 3410
Ser. no. 09250023

CALIBRATION Cond
Calibration date 15.03.2014 16:13:33
TetraCon 925
Ser. no. 09250033

Cell constant 0.476 1/cm      25.0 °C
Sensor                      +++
```

Calibration evaluation

After calibration, the meter automatically evaluates the current status of the calibration. The evaluation appears on the display and in the calibration record.

Display	Calibration record	Cell constant [cm ⁻¹]
	+++	Within the range 0.450 ... 0.500 cm ⁻¹

Display	Calibration record	Cell constant [cm^{-1}]
Error Eliminate the error according to chapter 6 WHAT TO DO IF...	Error	Outside the range 0.450 ... 0.500 cm^{-1}

Determining the cell constant

For this calibration procedure, the *Type* setting must be set to *cal*. Proceed as follows to determine the cell constant:

1	Connect an IDS conductivity sensor to the meter.
2	In the measured value display, select the conductivity parameter with <M> .
3	Start the calibration with <CAL> . The cell constant that was calibrated last is displayed.

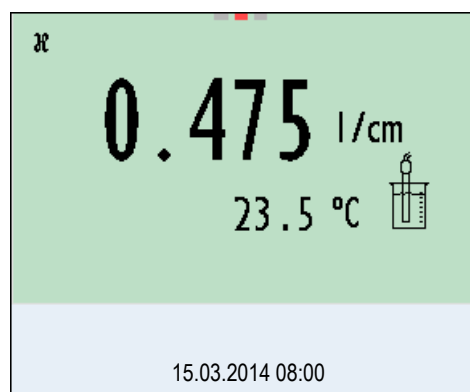

4	Immerse the IDS conductivity sensor in the control standard solution, 0.01 mol/l KCl.
5	Start the measurement with <MENU/ENTER> . The measured value is checked for stability (stability control). The [AR] status indicator is displayed. The measured parameter flashes.
6	Wait for the measurement with stability control to be completed ([HOLD][AR]) display or accept the calibration value with <MENU/ENTER> . The calibration record is displayed and output to the interface.
7	Switch to the measured value display with <MENU/ENTER> .

Displaying the calibration record

4.9.6 Displaying calibration records

The calibration data can be displayed and then output to the interface.

The calibration record of the last calibration is to be found under the menu item, *Calibration / Calibration record*. To open it in the measured value display, press the **<CAL__>** key.

The calibration records of the last 10 calibrations are to be found in the menu, *Calibration / Calibration data storage / Display*. To open the *Calibration* menu, press the **<MENU/ENTER>** key in the measured value display.

Menu item	Setting/function	Description
<i>Calibration / Calibration data storage / Display</i>	-	Displays the calibration records. Further options: <ul style="list-style-type: none"> ● Scroll through the calibration records with <◀><▶>. ● Output the displayed calibration record to the interface with <PRT>. ● Output all calibration records to the interface with <PRT__>. ● Quit the display with <ESC>. ● Switch directly to the measured value display with <M>.
<i>Calibration / Calibration data storage / Output to USB flash drive or printer</i>	-	Outputs the calibration data storage to the interface USB-B (USB flash drive/USB printer)
<i>Calibration / Calibration data storage / Output to RS232/USB</i>	-	Outputs the calibration data storage to the interface USB-B (PC)

4.10 Turbidity measurement (VisoTurb® 900-P)

4.10.1 General information

Measured parameters

You can measure the following parameters:

- FNU
- NTU



Note

The sensor connection and the USB-B (device) interface are galvanically isolated. This facilitates interference-free measurements also in grounded measuring media.

The sensor connection and the USB-B (device) interface are galvanically isolated. This facilitates interference-free measurements also in the following cases:

- Measurement in grounded test samples
- Measurement with several sensors connected to one Multi 3410 in one test sample

Preparatory activities

- Avoid gas bubbles (e.g. air bubbles) in the test sample.
- Use suitable vessels for measurement and calibration (see operating manual of the VisoTurb® 900-P sensor).
- Heed the minimum depth of immersion for the sensor

Perform the following preparatory activities when you want to measure:

1	Connect a turbidity sensor to the measuring instrument. The turbidity measuring screen is displayed. The data for the connected IDS turbidity sensor are automatically taken over.
2	Fill the test sample into a lightproof measuring vessel up to a level of at least 8 cm.
3	When immersing the sensor in the test sample, hold the sensor at an angle.
4	For measuring, position the sensor upright.
5	Position the sensor in a way that meets the following requirements. <ul style="list-style-type: none"> ● Distance to the bottom: 6 cm ● Distance to the walls of the vessel: 2 cm ● Minimum depth of immersion: 2 cm



Note

To position the sensor optimally and permanently while it is measuring, fix it on a support.

4.10.2 Measuring

You can carry out turbidity measurements as follows:

- | | |
|---|--|
| 1 | Perform the preparatory activities according to section 4.10.1. |
| 2 | Immerse the sensor in the test sample at an angle and then position it in the measuring vessel (see section 4.10.1). |

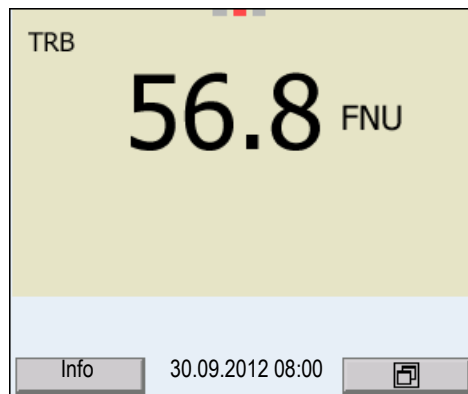

Selecting the displayed measured parameter

You can switch between the following displays with **<M>**:

- Turbidity [FNU]
- Turbidity [NTU]

Freezing the measured value (HOLD function)

With the HOLD function, you can freeze the current measured value. The displayed measured value stops changing until you switch the HOLD function off.

- | | |
|---|--|
| 1 | Freeze the measured value with <AR> . The [HOLD] status indicator is displayed. |
|---|--|



Note

If the HOLD function is active, you can, e.g. start a manual measurement with stability control.

- | | |
|---|---|
| 2 | Release the frozen measured value again with <AR> . The HOLD function is switched off. The [HOLD] status display disappears. |
|---|---|

Stability control (AutoRead)

The stability control function (AutoRead) continually checks the stability of the measurement signal. The stability has a considerable impact on the reproducibility of measured values. The display of the measured

parameter flashes until a stable measured value is available.

Irrespective of the setting for automatic *Stability control* (see section 4.4.3) in the *System* menu, you can start the *Stability control* function manually at any time.

1	Freeze the measured value with <AR> . The [HOLD] status indicator is displayed.
2	Using <MENU/ENTER> , activate the <i>Stability control</i> function manually. The [AR] status indicator appears while the measured value is assessed as not stable. A progress bar is displayed and the display of the measured parameter flashes. The [HOLD][AR] status indicator appears as soon as a stable measured value is recognized. The progress bar disappears and the display of the measured parameter stops flashing. The current measurement data are output to the interface. Measurement data meeting the stability control criterion are marked by AR.



Note

You can prematurely terminate the *Stability control* function manually with **<MENU/ENTER>** at any time. If the *Stability control* function is prematurely terminated, the current measurement data are output to the interface without the AutoRead info.

3	Using <MENU/ENTER> , start a further measurement with <i>Stability control</i> . or Release the frozen measured value again with <AR> . The display switches to the measured value display. The [AR][HOLD] status display disappears.
---	---

Criteria for a stable measured value

The *Stability control* function checks whether the measured values are stable within the monitored time interval.

Measured parameter	Time interval	Stability in the time interval
Turbidity (FNU/NTU)	15 seconds	Δ : better than 1.0% of measured value

The minimum duration until a measured value is assessed as stable is the monitored time interval. The actual duration is mostly longer.

4.10.3 Settings for turbidity sensors

Settings

The settings are made in the menu for the measured parameter, turbidity. To open the settings, display the required measured parameter in the measured value display and press the **<MENU/ENTER>** key. After completing the settings, switch to the measured value display with **<M>**.

The possible settings are individually displayed for each sensor. Default settings are printed in **bold**.

**Setting menu
VisoTurb® 900-P**

Menu item	Possible setting	Explanation
<i>Calibration / Calibration record</i>	-	Displays the calibration record of the last calibration.
<i>Calibration / Calibration data storage / Display</i>	-	Displays the last calibration records (max. 10)
<i>Calibration / Calibration data storage / Output to USB flash drive or printer</i>	-	Outputs the stored calibration data to a connected USB memory device/USB printer)
<i>Calibration / Calibration data storage / Output to RS232/USB</i>	-	Outputs the calibration data storage to the interface
<i>Calibration / Calibration interval</i>	1 ... 30 ... 999 d	<i>Calibration interval</i> for the turbidity sensor (in days). The meter reminds you to calibrate regularly by the flashing sensor symbol in the measuring screen.
<i>Resolution</i>	0.1 1	Resolution of the FNU/NTU display
<i>Reset</i>	-	Resets all sensor settings to the delivery condition (see section 4.14.1).

4.10.4 Calibration

Why calibrate?

The calibration line of the sensor is determined and stored through calibrating.

When to calibrate?

- When the calibration interval has expired
- at regular intervals

Calibration standards

Calibrate with 1 to 3 turbidity standard solutions. The standard solutions must be selected in the following order.

Standard solution	Range (FNU/NTU)
1	0.0 ... 1.0
2	5.0 ... 200.0
3	200.0 ... 4000.0

The turbidity expected in the measurement dictates the number and selection of the standards. Calibration has to be carried out for the range with the highest turbidity to be expected and for all lower ranges. The standard solutions for this have to be selected in ascending order, starting with standard 1.

Example:

If you expect turbidity values in the range 200 ... 4000 FNU/NTU, you have to carry out a 3-point calibration.

The measurement precision is also dependent on the selected standard solutions. Therefore, the selected standard solutions should cover the value range expected of the turbidity measurement.

If the measured turbidity is outside the measurement range, OFL is displayed.



As the standard with turbidity value 0.0 FNU you can use clean tap water or filtered, deionized water in a suitable calibration vessel, depending on the required quality (see section 4.10.1). This standard should be freshly prepared prior to every calibration. Suitable bottles are listed in the price list of the WTW catalog "Lab and field instrumentation".

Standards with turbidity values for the calibration ranges 2 and 3 are available as accessories (see price list of the WTW catalog "Lab and field instrumentation"). Calibration can be carried out in the bottles the standards are delivered in. The standards can be used several times within their shelf life.

Replace the standards solutions if you have any doubts concerning their quality or after the expiration date.

1	Perform the preparatory activities according to section 4.10.1.
2	Connect the turbidity sensor to the measuring instrument. The turbidity measuring screen is displayed.
3	Keep the standard solutions ready in suitable calibration vessels.

- 4 | In the measured value display, select the TRB measuring window with <▲> <▼> and <M>.
- 5 | Start the calibration with <CAL>. The calibration display appears.

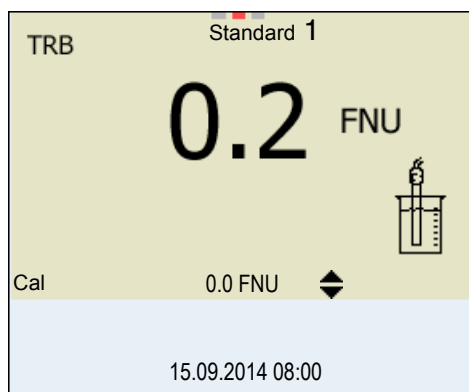

- 6 | Thoroughly rinse the turbidity sensor with distilled water and dry it with a lint-free cloth.
- 7 | Immerse the turbidity sensor in the test sample at an angle.
- 8 | Position the turbidity sensor in the measuring vessel (see section 4.10.1).
- 9 | Use <▲> <▼> and <◀><▶> to set the concentration of the standard solution for each digit and confirm with <MENU/ENTER>. The standard solution is measured. The measured value is checked for stability (AutoRead).
- 10 | Wait for the end of the AutoRead measurement. The calibration display for the next standard solution appears.

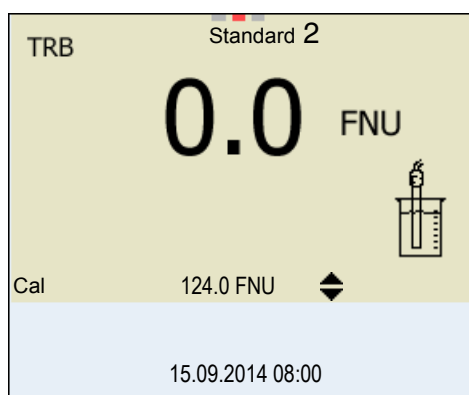

Continuing with two-point calibration

- 11 | Thoroughly rinse the turbidity sensor with distilled water and dry it with a lint-free cloth.

12	Immerse the turbidity sensor in the test sample at an angle.
13	Position the turbidity sensor in the measuring vessel (see section 4.10.1).
14	Use <▲> <▼> and <◀><▶> to set the concentration of the standard solution for each digit and confirm with <MENU/ENTER>. The standard solution is measured. The measured value is checked for stability (AutoRead).
15	Wait for the end of the AutoRead measurement. The calibration display for the next standard solution appears.

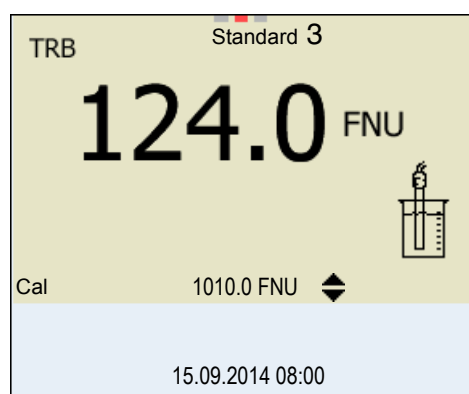

16	If necessary, terminate the calibration as a two-point calibration with <M>. The new calibration values are displayed. or Continue with three-point calibration.
----	--

Continuing with three-point calibration

Repeat the steps 11 to 15 with the third standard solution. The new calibration values are displayed after the last calibration step was completed.

4.10.5 Calibration data

Displays the calibration data



The calibration record of the last calibration is to be found under the menu item, <MENU/ENTER> / *Calibration* / / *Calibration record*. To open it, press the <CAL__> key in the measured value display.

The calibration records of the last 10 calibrations are to be found in the menu, *Calibration* / *Calibration data storage* / *Display*. To open the *Calibration* menu, press the <MENU/ENTER> key in the measured value display.

Menu item	Setting/ function	Explanation
<i>Calibration / Calibration data storage / Display</i>	-	Displays the calibration record. Further options: <ul style="list-style-type: none"> ● Scroll through the calibration records with <◀><▶>. ● Output the displayed calibration record to the interface with <PRT>. ● Output all calibration records to the interface with <PRT __>. ● Quit the display with <ESC> or <MENU/ENTER>. ● Switch directly to the measured value display with <M>.
<i>Calibration / Calibration data storage / Output to RS232/USB</i>	-	Outputs the calibration records to the interface.

Calibration evaluation

After calibrating, the meter automatically evaluates the calibration.

Display	Calibration record	Explanation
	+++	Optimum calibration
		Good calibration

**Calibration record
(example)**

```
Multi 3410
Ser. no. 12345678

CALIBRATION TRB:
VisoTurb 900-P
Ser. no. 14E999003
18.09.2014 08:09:10

# 1      0.0 FNU
# 2      124.0 FNU
Sensor                    +++
```

4.11 Data storage

You can transmit measured values (datasets) to the data storage:

- Manual storage (see section 4.11.1)
- Automatic storage at intervals (see section 4.11.2)

Each storage process transmits the current dataset to the interface at the same time.

Measurement dataset

A complete dataset consists of:

- Date/time
- Meter name, series number
- Sensor name, series number
- ID number
- Measured value of the connected sensor
- Measured temperature value of the connected sensor
- AutoRead info: *AR* appears with the measured value if the AutoRead criterion was met while storing (stable measured value). Otherwise, the *AR* display is missing.
- Calibration evaluation:
 - 4 levels (+++, ++, +, -, or no evaluation) or
 - QSC (percentage)

Storage locations

The Multi 3410 meter has two measurement data memories. The measured values recorded either manually or automatic are stored separately in individual measurement data memories.

Storage	Maximum number of datasets
<i>Manual data storage</i>	500
<i>Automatic data storage</i>	10000

4.11.1 Manual storage

You can transmit a measurement dataset to the data storage as follows. The dataset is at the same time output to the interface:

- 1 Press the **<STO>** key shortly.
The menu for manual storage appears.

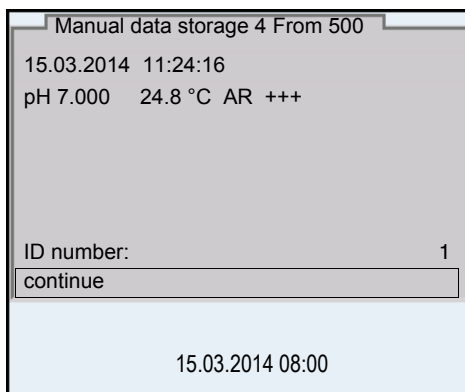

- 2 If necessary, change and confirm the ID number (1 ... 10000) with **<▲><▼>** and **<MENU/ENTER>**.
The dataset is stored. The meter switches to the measured value display.

If the storage is full

When all storage locations are occupied, it is not possible to continue storing. Then you can e.g. transmit the stored data to a PC or a USB flash drive (see section 4.11.3) and subsequently erase the storage (see section 4.11.4).

4.11.2 Automatic storage at intervals

The storage interval (*Interval*) determines the time interval between automatic storage processes. Each storage process transmits the current dataset to the interface at the same time.

Configuring the automatic storage function

- 1 Press the **<STO__>** key.
The menu for automatic storage appears.

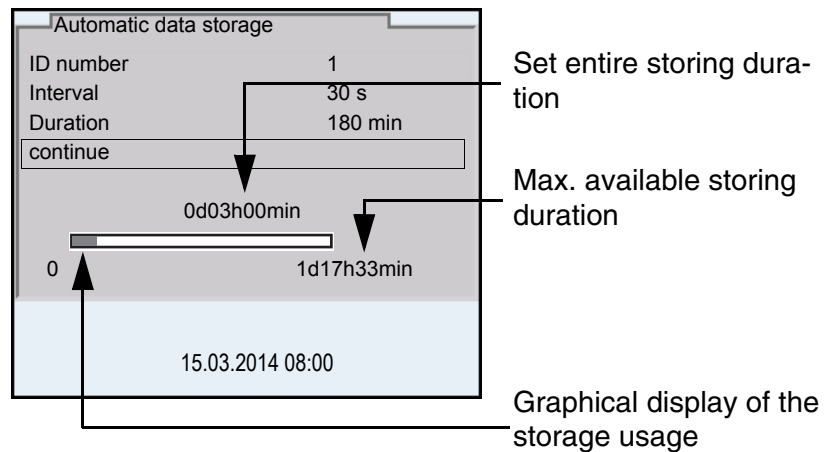

Settings You can configure the automatic storage function with the following settings:

Menu item	Possible setting	Description
ID number	1 ... 10000	ID number for the dataset series
Interval	1 s, 5 s, 10 s, 30 s, 1 min, 5 min, 10 min, 15 min, 30 min, 60 min	Storage interval. The lower limit of the storage interval can be restricted by the number of free storage locations. The upper limit is restricted by the storage duration.
Duration	1 min ... x min	Storage duration. Specifies after which time the automatic storage should be terminated. The lower limit of the storage duration is restricted by the storage interval. The upper limit is restricted by the number of free storage locations.

Starting the automatic storage function

To start the automatic storage function, select *continue* with <▲><▼> and confirm with <MENU/ENTER>. The meter switches to the measured value display.

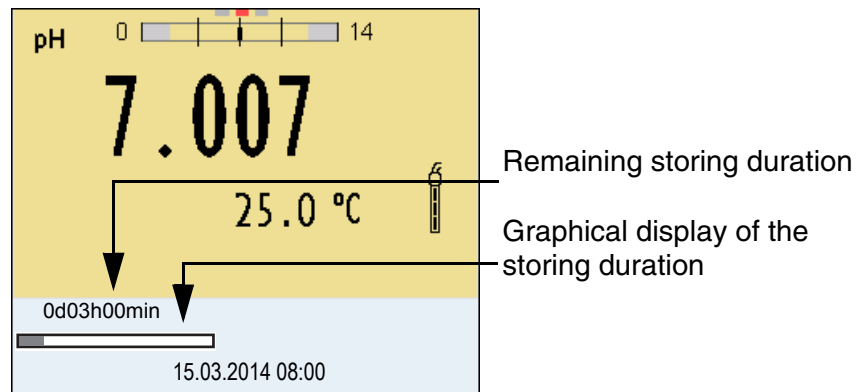

The active automatic storage function can be recognized by the progress bar in the status line. The progress bar indicates the remaining storing duration.



Note

If the automatic storage function is activated, only the following keys are active: **<M>**, **<STO __>** and **<On/Off>**. The other keys and the automatic switch-off function are deactivated.

Terminating the automatic storage function prematurely

Proceed as follows to switch off the automatic storage function before the adjusted storage duration has expired:

- 1 Press the **<STO __>** key.
The following window appears.

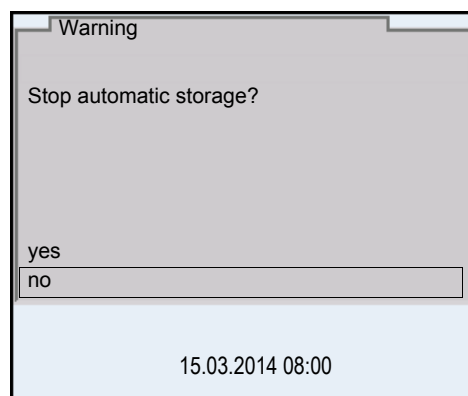

- 2 Using **<▲>****<▼>**, select **yes** and confirm with **<MENU/ENTER>**.
The meter switches to the measured value display.
The automatic storage function is terminated.

4.11.3 Editing the measurement data storage

The contents of the manual or automatic measurement data storage can be shown on the display.

Each of the measurement data storages has a function to erase the entire contents.

Editing the data storage

The storage is edited in the menu, *Storage & config / Data storage*. To open the *Storage & config* menu, press the <MENU/ENTER__> key in the measured value display.

Open the manual or automatic storage directly with the <RCL> or <RCL__> key.



Note

The settings are explained here using the manual storage as an example. The same settings and functions are available for the automatic storage.

Settings

Menu item	Setting/function	Description
<i>Data storage / Manual data storage / Display</i>	-	Displays all measurement datasets page by page. Further options: <ul style="list-style-type: none"> ● Scroll through the datasets with <◀><▶>. ● Output the displayed dataset to the interface with <PRT>. ● Quit the display with <ESC>.
<i>Data storage / Manual data storage / Output to USB flash drive or printer</i>	-	Outputs all stored measurement data to a connected USB flash drive/USB printer
<i>Data storage / Manual data storage / Output to RS232/USB</i>	-	Outputs all stored measurement data to the interface
<i>Data storage / Manual data storage / Erase</i>	-	Erases the entire manual measurement data storage. Note: All calibration data remains stored when this action is performed.

Display presentation of a dataset

Manual data storage		3 of 64 ◀▶
15.03.2014 11:24:16	ID number: 1	
SenTix 940	B20234008565	
pH 7.000 24.8 °C AR	Sensor: +++	
15.03.2014 08:00		

Sample printout

```

15.03.2014 09:56:20
Multi 3410
Ser. no. 09250023

SenTix 940
Ser. no. B092500013
ID number 2
pH 6.012 24.8 °C, AR, Sensor: +++
-----

15.03.2014 10:56:20
Multi 3410
Ser. no. 09250013

SenTix 940
Ser. no. B092500013
ID number 2
pH 6.012 24.8 °C, AR, Sensor: +++
-----

etc...
```

Quitting the display

To quit the display of stored measurement datasets, you have the following options:

- Switch directly to the measured value display with **<M>**.
- Quit the display and move to the next higher menu level with **<ESC>**.

4.11.4 Erasing the measurement data storage

How to erase the measurement data memory is described in section 4.11.3 EDITING THE MEASUREMENT DATA STORAGE.

4.12 Transmitting data

4.12.1 USB interfaces

The meter has the following interfaces:

- USB-B interface (*USB Device*)
e.g. to connect a PC
- USB-A interface (*USB Host*),
e.g. to connect a USB flash drive or a

Via the USB-B interface (*USB Device*) you can transmit data to a PC or printer and update the meter software.

Via the USB-A interface (*USB Host*) it is possible to transfer data to an external USB memory device/USB printer.

4.12.2 Connecting the PC (USB-B interface (*USB Device*))

Connect the Multi 3410 to the PC via the USB-B interface.

System requirements of the PC for installation of the USB driver:

- PC with at least one free USB connection and CD-ROM drive
- Windows 2000, Windows XP, Windows Vista or Windows 7.

Installation of the USB driver on the PC

1	Insert the supplied installation CD in the CD drive of your PC.
2	Install the driver from the CD. Follow the Windows installation instructions as necessary.
3	Connect the Multi 3410 to the PC via the USB-B interface. The meter is listed as a virtual COM interface among the connections in the Windows instrument manager.
4	Set the same transmission data at the connected instrument (PC): <ul style="list-style-type: none"> ● Baud rate: to be selected in the range 1200 ... 19200 ● Handshake: RTS/CTS ● Set at the PC only: <ul style="list-style-type: none"> – Parity: none – Data bits: 8 – Stop bits: 1

4.12.3 Connecting a USB memory device/USB printer (USB-A interface (*USB Host*))

Connect the USB-A interface (*USB Host*) of the Multi 3410 to a USB flash drive/USB printer.

1	Connect a USB memory device/USB printer to the <i>USB Host</i> interface.
2	For USB printers: Connect the power pack to the Multi 3410 (see section 3.3.2).

Suitable USB printers:

Model	Type	Paper width
Citizen CT-S281	Thermal transfer printer	58 mm
Seiko Instruments Inc. DPU-S445	Thermal transfer printer	58 mm
Star SP700 with USB interface*	Matrix printer	76 mm

* Recommended printer settings for Star SP700:
 - CodePage 437
 - DIP switch 1...7: =ON, DIP switch 8: OFF
 Details: see operating manual of your printer.

4.12.4 Options for data transmission to the USB-B (PC) interface and the USB-A (USB printer) interface

Via the USB-B interface you can transmit data to a PC.

Via the USB-A interface, you can transmit data to a USB printer or USB memory device. How to transmit data to a USB memory device is described in an extra section (see section 4.12.5).

The following table shows which data are transmitted to the interface in which way:

Data	Control	Operation / description
------	---------	-------------------------

Current measured values of all connected sensors	Manual	<ul style="list-style-type: none"> ● With <PRT> ● Simultaneously with every manual storage process (see section 4.11.1)
	Automatic, at intervals	<ul style="list-style-type: none"> ● With <PRT__>. Then you can set the transmission interval ● Simultaneously with every automatic storage process (see section 4.11.2)
Stored measured values	Manual	<ul style="list-style-type: none"> ● Displayed dataset with <PRT> after calling up from the storage ● All datasets with the <i>Output to RS232/USB</i> function (USB-B interface) ● All datasets with the <i>Output to USB flash drive or printer</i> function (USB-A interface) <p>For details, see section 4.11.3.</p>
calibration records	Manual	<ul style="list-style-type: none"> ● Displayed calibration record with <PRT> ● All calibration records with <PRT__> <p>For details, see section 4.12.</p>
	Automatic	<ul style="list-style-type: none"> ● At the end of a calibration procedure



Note

The following rule applies: With the exception of the menus, shortly pressing the <PRT> key generally outputs the display contents to the interface (displayed measured values, measuring datasets, calibration records). If there is a USB-B connection (such as to a PC) at the same time, the data are output only to the USB-B interface.

4.12.5 Data transmission to the USB-A interface (USB memory device)

Via the USB-A interface, you can transmit data to a USB memory or USB printer device. How to transmit data to a USB printer device is described in an extra section (see section 4.12.5).

The following table shows which data are transmitted to the interface in which way:

Data	Control	Operation / description
Stored measured values	Manual	All datasets with the <i>Output to RS232/USB</i> function. For details, see section 4.11.3.
Calibration data storage	Manual	All stored calibration records of a sensor with the <i>Output to USB flash drive or printer</i> function. For details, see the menu for calibration and measurement settings of the sensor.

4.12.6 MultiLab Importer

With the aid of the MultiLab Importer software, you can record and evaluate measurement data with a PC.



Note

More detailed information can be found in the MultiLab Importer operating manual.

4.13 MultiLab User

The user administration function is activated via the *MultiLab User* PC software.

The *MultiLab User* PC software can be found on the enclosed CD-ROM.



Note

More detailed information can be found in the MultiLab User operating manual.

4.14 Reset

You can reset (initialize) all sensor settings and sensor-independent settings separately from each other.

4.14.1 Resetting the measurement settings



Note

The calibration data are reset to the default settings together with the measuring parameters. Recalibrate after performing a reset.

pH

The following settings for pH measurements are reset to the default settings with the *Reset* function:

Setting	Default settings
Buffer	AutoCalTEC
Cal. interval	7 d
Unit for slope	mV/pH
Measured parameter	pH
pH resolution	0.001
mV resolution	0.1
Asymmetry	0 mV
Slope	-59.2 mV
Man. temperature	25 °C
Single-point calibration	off

The sensor settings are reset under the *Reset* menu item in the menu for calibration and measurement settings. To open the settings, display the required parameter in the measured value display and press the <MENU/ENTER> key.

ORP The following settings for ORP measurements are reset to the default settings with the *Reset* function:

Setting	Default settings
mV resolution	0.1
Man. temperature	25 °C

The sensor settings are reset under the *Reset* menu item in the menu for calibration and measurement settings. To open the settings, display the required parameter in the measured value display and press the <MENU/ENTER> key.

Dissolved oxygen The following settings for D.O. measurements are reset to the default settings with the *Reset* function:

Setting	Default settings
Cal. interval	180d
Check interval	60 d
Measured parameter	D.O. concentration
Relative slope (S_{Rel})	1.00
Salinity (value)	0.0

Setting	Default settings
Salinity (function)	Off

The sensor settings are reset under the *Reset* menu item in the menu for calibration and measurement settings. To open the settings, display the required parameter in the measured value display and press the **<MENU/ENTER>** key.

Conductivity

The following settings for conductivity measurements are reset to the default settings with the *Reset* function:

Setting	Default settings
Cal. interval	150 d
Measured parameter	χ
Cell constant (c)	Depending on the connected measuring cell: 0.475 cm ⁻¹ (calibrated) 0.475 cm ⁻¹ (set up) 0.100 cm ⁻¹
Temperature compensation	nLF
Reference temperature	25 °C
Temperature coefficient (TC) of the linear temperature compensation	2.000 %/K
TDS factor	1,00

The sensor settings are reset under the *Reset* menu item in the menu for calibration and measurement settings. To open the settings, display the required parameter in the measured value display and press the **<MENU/ENTER>** key.

4.14.2 Resetting the system settings

The following system settings can be reset to the default condition:

Setting	Default settings
Language	English
Acoustic signal	on
Volume	6
Baud rate	4800 Baud
Output format	ASCII
Decimal separator	.
Brightness	15
Illumination	Auto
Switchoff time	1 h
Temperature unit	°C
USB Host	on
Stability control	on

The system settings are reset in the menu, *Storage & config / System / Reset*. To open the *Storage & config* menu, press the **<MENU/ENTER__>** key in the measured value display.

5 Maintenance, cleaning, disposal

5.1 Maintenance

The only maintenance activity required is replacing the batteries.



Note

See the relevant operating manuals of the IDS sensors for instructions on maintenance.

5.1.1 Replacing the rechargeable batteries

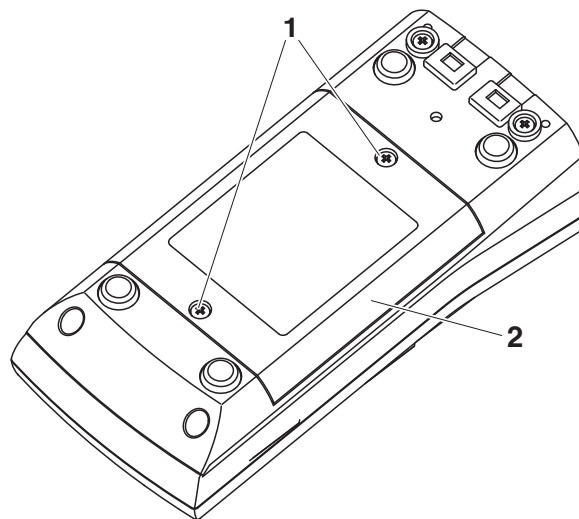

1	Unscrew the two screws (1) on the underside of the meter.
2	Open the battery compartment (2) on the underside of the meter.
3	Remove the four rechargeable batteries from the battery compartment.



CAUTION

Make sure that the poles of the rechargeable batteries are positioned correctly.

The ± signs on the batteries must correspond to the ± signs in the battery compartment.

4	Place four new rechargeable batteries (type Mignon AA) in the battery compartment.
5	Close the battery compartment (2) and tighten the screws (1).



Note

Dispose of used batteries according to the local regulations of your

country.

End users within the European Union are obligated to return used batteries (even ecologically compatible ones) to a collection point set up for recycling purposes.

Batteries are marked with the crossed-out waste container symbol. Therefore, they may not be disposed with the domestic waste.

5.2 Cleaning

Occasionally wipe the outside of the measuring instrument with a damp, lint-free cloth. Disinfect the housing with isopropanol as required.



CAUTION

The housing is made of synthetic material (ABS). Thus, avoid contact with acetone or similar detergents that contain solvents. Remove any splashes immediately.

5.3 Packing

This meter is sent out in a protective transport packing. We recommend: Keep the packing material. The original packing protects the meter against damage during transport.

5.4 Disposal



Note

Within the European Union, the batteries are removed at a specialized treatment center at the instrument's end of life. The instruments are taken to one of those specialized treatment centers via the recycling system set up for this purpose.

6 What to do if...

6.1 General information

Sensor symbol flashes	Cause <ul style="list-style-type: none"> – Calibration interval expired 	Remedy <ul style="list-style-type: none"> – Recalibrate the measuring system
 Display	Cause <ul style="list-style-type: none"> – Batteries almost empty 	Remedy <ul style="list-style-type: none"> – Charge the batteries (see section 3.3.2 CONNECTING THE POWER PACK / CHARGING THE BATTERIES) – Replace the batteries (see section 5.1 MAINTENANCE)
Meter does not react to keystroke	Cause <ul style="list-style-type: none"> – Operating condition undefined or EMC load unallowed 	Remedy <ul style="list-style-type: none"> – Processor reset: Press the <ENTER> and <On/Off> key simultaneously
You want to know which software version is in the meter or IDS sensor	Cause <ul style="list-style-type: none"> – E. g., a question by the service department 	Remedy <ul style="list-style-type: none"> – Switch on the meter. – Open the menu, <ENTER__> / <i>Storage & config / System / Service information</i>. The instrument data are displayed. <p>or</p> <ul style="list-style-type: none"> – Connect the sensor. Press softkey [<i>Info</i>]/[<i>More</i>]. The sensor data are displayed (see section 4.5)

**Data transmission to
USB memory device
does not work**

Cause

- Connected USB memory device has not been recognized, e. g.
 - the USB memory device has been formatted to a file system which is not supported (e. g. NTFS)

Remedy

- Use other USB memory device
- Reformat the USB memory device to FAT 16 or FAT 32 file system
(**Caution:** Reformatting erases all data on the USB memory device. Back up all data before reformatting.)

**Data transmission to
USB printer device does
not work**

Cause

- The USB-B interface is connected to a PC
- Connected USB memory device does not work

Remedy

- Disconnect the PC from the USB-B interface
- Use a suitable USB printer device (see section 4.12.3)
- Check printer settings (see section 4.12.3)

- No power pack connected

- Connect the power pack

**Error message,
Only use rechargeable
batteries!
Ni-MH 1.2 V, >2100 mAh**

Cause

- A voltage that is unusual for NiMH rechargeable batteries was found.

Remedy

- Disconnect the power pack from the meter.
- Check whether there are suitable rechargeable batteries (*Ni-MH 1.2 V, >2100 mAh*) in the battery compartment.
 - **Unsuitable batteries:**
Insert suitable rechargeable batteries and reconnect the power pack.
 - **Suitable batteries:**
Connect the power pack and close the error message with <[ESC]> or <M>.



CAUTION

Unsuitable batterie types can cause damage during the charging process.

Error message, <i>Memory error 1</i>	Cause	Remedy
	– Instrument storage was not found	– <i>Please contact the service.</i>

6.2 pH

Error message, OFL, UFL

Cause	Remedy
IDS pH sensor:	
– Measured value outside the measuring range	– Use suitable IDS pH sensor
– Air bubble in front of the junction	– Remove air bubble
– Air in the junction	– Extract air or moisten junction
– Gel electrolyte dried out	– Exchange IDS pH sensor

Error message, Error

Cause	Remedy
IDS pH sensor:	
– The values determined for zero point and slope of the IDS pH sensor are outside the allowed limits.	– Recalibrate
– Junction contaminated	– Clean junction
– IDS pH sensor broken	– Exchange IDS pH sensor
– Buffer solutions:	
– The used buffer solutions are not suitable for the selected buffer set	– Select a different buffer set or – Use different buffer solutions
– Buffer solutions too old	– Use only once. Note the shelf life
– Buffer solutions depleted	– Change solutions

No stable measured value	Cause	Remedy
	IDS pH sensor:	
	– Junction contaminated	– Clean junction
	– Membrane contaminated	– Clean membrane
	Test sample:	
	– pH value not stable	– Measure with air excluded if necessary
	– Temperature not stable	– Adjust temperature if necessary
	IDS pH sensor + test sample:	
	– Conductivity too low	– Use suitable IDS pH sensor
	– Temperature too high	– Use suitable IDS pH sensor
	– Organic liquids	– Use suitable IDS pH sensor

Obviously incorrect measured values	Cause	Remedy
	IDS pH sensor:	
	– IDS pH sensor unsuitable	– Use suitable IDS sensor
	– Temperature difference between buffer and test sample too great	– Adjust temperature of buffer or sample solutions
	– Measurement procedure not suitable	– Follow special procedure

6.3 Dissolved oxygen

Error message, OFL	Cause	Remedy
		– Measured value outside the measuring range

Error message, Error	Cause	Remedy
	– Sensor contaminated	– Clean the sensor
	– Measured temperature outside the operating conditions (OFL/UFL displayed instead of temperature value)	– Observe the temperature range for the measuring medium
	– Defective sensor	– Replace sensor

**Note**

More information, as well as notes on cleaning and replacement of sensors, are given in the documentation of your sensor.

6.4 Conductivity

Error message, OFL	Cause	Remedy
	– Measured value outside the measuring range	– Use suitable IDS conductivity sensor

Error message, Error	Cause	Remedy
	– Sensor contaminated	– Clean sensor and replace it if necessary
	– Calibration solution not suitable	– Check calibration solutions

**Note**

More information, as well as notes on cleaning and replacement of sensors, are given in the documentation of your sensor.

6.5 Turbidity

Implausible turbidity values	Cause	Remedy
	<ul style="list-style-type: none"> – There are gas bubbles (e.g. air bubbles) in front of the measurement window 	<ul style="list-style-type: none"> – Remove the gas bubbles, e.g. by immersing the sensor at an angle
	<ul style="list-style-type: none"> – Incorrect calibration, e.g.: <ul style="list-style-type: none"> – Unsuitable calibration standard solutions (e.g. too old) – Unsuitable calibration environment (e.g. gas bubbles, reflection, light) 	<ul style="list-style-type: none"> – Check the calibration
	<ul style="list-style-type: none"> – Minimum depth of immersion not observed 	<ul style="list-style-type: none"> – Heed the minimum depth of immersion of the sensor (2 cm)
Error message, OFL	Cause	Remedy
	<ul style="list-style-type: none"> – Measured value outside the measuring range 	<ul style="list-style-type: none"> – Select a suitable measuring medium
Measured values too low	Cause	Remedy
	<ul style="list-style-type: none"> – Measurement window soiled 	<ul style="list-style-type: none"> – Clean the measurement window
Measured values too high	Cause	Remedy
	<ul style="list-style-type: none"> – Reflection at the walls or bottom of the measuring vessel 	<ul style="list-style-type: none"> – Keep the minimum distance of the sensor towards the walls and bottom of the measuring vessel (see section 6.5)
	<ul style="list-style-type: none"> – Incidence of light 	<ul style="list-style-type: none"> – Use a light-proof measuring vessel



Note

More information and instructions on cleaning and exchange of sensors are given in the documentation of your sensor.

7 Technical data

7.1 General data

Dimensions	Approx. 180 x 80 x 55 mm	
Weight	Approx. 0.4 kg	
Mechanical structure	Type of protection	IP 67
Electrical safety	Protective class	III
Test certificates	CE, cETLus	
Ambient conditions	Storage	- 25 °C ... + 65 °C
	Operation	-10 °C ... + 55 °C With the power pack connected (batteries being charged): 0 °C ... + 40 °C
	Allowable relative humidity	Annual mean: < 75 % 30 days/year: 95 % Other days: 85 %
Power supply	Rechargeable batteries	4 x 1.2 V NiMH rechargeable batteries, type AA
	Operational life	Approx. 150 h [#]
	Power pack (charging device)	Kuantech Co. Ltd. KSAC 0900110W1UV-1 Input: 100 ... 240 V ~ / 50 ... 60 Hz / 270 mA Output: 9 V = / 1.1 A Connection max. overvoltage category II Primary plugs contained in the scope of delivery: Euro, US, UK and Australian.
USB interface (device)	Type	USB 1.1 USB-B (Device), PC
	Baud rate	adjustable: 1200, 2400, 4800, 9600, 19200 Baud
	Data bits	8
	Stop bits	2
	Parity	None
	Handshake	RTS/CTS
	Cable length	max. 3 m

[#] The operational life is shorter if, e.g.
- the maximum display illumination is set

USB interface (host)	Type	USB 2.0 USB-A (host), USB device
Applicable directives and standards	EMC	EC directive 2004/108/EC EN 61326-1 EN 61000-3-2 EN 61000-3-3 FCC Class A
	Meter safety	EC directive 2006/95/EC EN 61010-1
	IP protection class	EN 60529

7.2 Measuring ranges, resolution, accuracy

Measuring ranges, accuracy	Variable	Measuring range	Accuracy
	Air pressure (absolute)*	300 ... 1100 mbar	± 4 mbar

* only available with connected D.O. sensor



Note

Further data are given in the documentation of your sensor.

FCC Class A Equipment Statement

Note: This equipment has been tested and found to comply with the limits for a Class A digital device, pursuant to Part 15 of the FCC Rules. These limits are designed to provide reasonable protection against harmful interference when the equipment is operated in a commercial environment. This equipment generates, uses, and can radiate radio frequency energy and, if not installed and used in accordance with the instruction manual, may cause harmful interference to radio communications. Operation of this equipment in a residential area is likely to cause harmful interference in which case the user will be required to correct the interference at his own expense. Changes or modifications not expressly approved by the manufacturer could void the user's authority to operate the equipment.

8 Lists

This chapter provides additional information and orientation aids.

Specialist terms The glossary briefly explains the meaning of the specialist terms. However, terms that should already be familiar to the target group are not described here.

Index The index will help you to find the topics that you are looking for.

Glossary

Adjusting To manipulate a measuring system so that the relevant value (e. g. the displayed value) differs as little as possible from the correct value or a value that is regarded as correct, or that the difference remains within the tolerance.

Asymmetry see zero point

AutoRange Name of the automatic selection of the measuring range.

Calibration Comparing the value from a measuring system (e. g. the displayed value) to the correct value or a value that is regarded as correct. Often, this expression is also used when the measuring system is adjusted at the same time (see adjusting).

D.O. partial pressure Pressure caused by the oxygen in a gas mixture or liquid.

Electromotive force of an electrode The electromotive force U of the combination electrode is the measurable electromotive force of an electrode in a solution. It equals the sum of all the galvanic voltages of the combination electrode. Its dependency on the pH results in the electrode function, which is characterized by the parameters, slope and zero point.

Junction The junction is a porous body in the housing wall of reference electrodes or electrolyte bridges. It arranges the electrical contact between two solutions and makes the electrolyte exchange more difficult. The expression, junction, is also used for ground or junctionless transitions.

Measured parameter The measured parameter is the physical dimension determined by measuring, e. g. pH, conductivity or D.O. concentration.

Measured value The measured value is the special value of a measured parameter to be determined. It is given as a combination of the numerical value and unit (e. g. 3 m; 0.5 s; 5.2 A; 373.15 K).

ORP voltage The ORP is caused by oxidizing or reducing substances dissolved in water if these substances become effective on an electrode surface (e. g. a gold or platinum surface).

Oxygen saturation	Short name for "Relative D.O. saturation".
pH value	The pH value is a measure of the acidic or basic effect of an aqueous solution. It corresponds to the negative decadic logarithm of the molal hydrogen ions activity divided by the unit of the molality. The practical pH value is the value of a pH measurement.
Potentiometry	Name of a measuring technique. The signal (depending on the measured parameter) of the electrode is the electrical potential. The electrical current remains constant.
Reset	Restoring the original condition of all settings of a measuring system.
Resolution	Smallest difference between two measured values that can be displayed by a meter.
Salinity	The absolute salinity S_A of seawater corresponds to the relationship of the mass of dissolved salts to the mass of the solution (in g/kg). In practice, this dimension cannot be measured directly. Therefore, the practical salinity according to IOT is used for oceanographic monitoring. It is determined by measuring the electrical conductivity.
Salt content	General designation for the quantity of salt dissolved in water.
Slope	The slope of a linear calibration function.
Stability control (AutoRead)	Function to control the measured value stability.
Standard solution	The standard solution is a solution where the measured value is known. It is used to calibrate a measuring system.
Test sample	Designation of the test sample ready to be measured. Normally, a test sample is made by processing the original sample. The test sample and original sample are identical if the test sample was not processed.
Zero point	The zero point of a pH combination electrode is the pH value at which the electromotive force of the pH combination electrode at a specified temperature is zero. Normally, this is at 25 °C.

Index

A

Air calibration beaker	68
Authorized use	18
Automatic switch-off	25
AutoRead	
Conductivity	73
O2	65
ORP	61
pH	38

B

Battery compartment	21, 95
---------------------	--------

C

Calibration	
Conductivity	79
O2	68
pH	42
Calibration evaluation	
Conductivity	79
O2	68
pH	46
Calibration interval	
Conductivity	76
O2	67
pH	47
Calibration points	
pH	45
Calibration records	
Conductivity	81
O2	70
pH	54
Cell constant	79
Connect the power pack	22
Connecting a PC	88, 90

D

Dataset	82
Date and time	31
Default settings	
Measured parameter	91
System settings	94
Display	11

E

Energy saving feature	23
-----------------------	----

F

Firmware update	107
-----------------	-----

I

Initial commissioning	21, 23
Initialize	91
Interval for calibration	47

K

Keys	10
------	----

M

Measured value display	27
Measurement accuracy	47
Measurement data storage	
Edit	86
Erase	86
Storage locations	82
Measurement dataset	82
Measuring	
Conductivity	72
O2	64
ORP voltage	60
pH	38
Menu for calibration and measurement settings	
Conductivity	76
O2	67
pH/ORP	40, 62
Menus (navigation)	27
Messages	28

O

Operational safety	18
--------------------	----

P

pH buffer sets	42
Precautions	17

R

Reset	91
RS232 interface	90

S

Safety	17
Scope of delivery	21

Setting the date	23
Setting the time	23
Single-point calibration	
pH	49, 52, 53
Slope	
pH	42
Slope, relative	68
Socket field	13
Stability control	
automatic	35
Conductivity	73
O2	65
ORP	61
pH	38
Storage interval	83
Storing in memory	63
Automatic	83
Manual	83

T

Temperature compensation	75
Temperature measurement	
Conductivity	71
O2	63
pH	37
Three-point calibration	
pH	50
Transmitting data	88
Transmitting measured values	88
Two-point calibration	
pH	49, 52, 54

Z

Zero point of pH combination electrode ..	42
---	----

9 Appendix: Firmware update

With the Multi 3410 you can update the firmware of your meter and IDS sensors.

9.1 Firmware update for the meter Multi 3410

General information

Available firmware updates for the meter are provided on the Internet. With the "Firmware Update " program and a PC you can update the firmware of the Multi 3410 to the newest version.

For the update you have to connect the meter to a PC.

For the update via the USB-B interface, the following is required:

- a free USB interface (virtual COM port) on the PC
- the driver for the USB interface (on the enclosed CD-ROM)
- the USB cable (included in the scope of delivery of the Multi 3410).

Program installation

1	Install the downloaded firmware update on a PC. An update folder is created in the Windows start menu. If an update folder already exists for the meter (or meter type), the new data are displayed there.
---	---

Program start

2	In the windows start menu, open the update folder and start the firmware update program for the meter
---	---

Firmware update

3	Using the USB interface cable, connect the Multi 3410 to a USB interface (virtual COM port) of the PC.
4	Switch on the Multi 3410.
5	In the firmware update program, start the update process with OK.
6	Follow the instructions of the firmware update program. During the programming process, a corresponding message and a progress bar (in %) are displayed. The programming process takes up to 15 minutes. A terminatory message is displayed after a successful programming process. The firmware update is completed.
7	Disconnect the Multi 3410 from the PC. The Multi 3410 is ready for operation again.

After switching the meter off and on you can check whether the meter has taken over the new software version (see page 109).

9.2 Firmware-Update for IDS Sensors

General information

Available firmware updates for IDS sensors are provided on the Internet. With the "Firmware Update" program and a PC you can update the firmware of an IDS sensor to the newest version.

For updating, connect the IDS sensor to the Multi 3410, and the Multi 3410 to a PC.

For the update via the USB-B interface, the following is required:

- a free USB interface (virtual COM port) on the PC
- the driver for the USB interface (on the enclosed CD-ROM)
- the USB cable (included in the scope of delivery of the Multi 3410).

Program installation

- | | |
|---|---|
| 1 | Install the downloaded firmware update on a PC.

An update folder is created in the Windows start menu. If an update folder already exists for the sensor (or sensor type), the new data are displayed there. |
|---|---|

Program start

- | | |
|---|--|
| 2 | In the windows start menu, open the update folder and start the firmware update program for the IDS sensor |
|---|--|

Firmware update

- | | |
|---|--|
| 3 | Connect the IDS sensor to the Multi 3410 meter. |
| 4 | Using the USB interface cable, connect the Multi 3410 to a USB interface (virtual COM port) of the PC. |
| 5 | Switch on the Multi 3410. |
| 6 | In the firmware update program, start the update process with OK. |
| 7 | Follow the instructions of the firmware update program. During the programming process, a corresponding message and a progress bar (in %) are displayed. The programming process takes up to 5 minutes. A terminatory message is displayed after a successful programming process. The firmware update is completed. |
| 8 | Disconnect the Multi 3410 from the PC. Meter and sensor are ready for operation again. |

After switching the meter off and on you can check whether the sensor has taken over the new software version (see page 109).

Xylem |'zīləm|

- 1) The tissue in plants that brings water upward from the roots;
- 2) a leading global water technology company.

We're 12,500 people unified in a common purpose: creating innovative solutions to meet our world's water needs. Developing new technologies that will improve the way water is used, conserved, and re-used in the future is central to our work. We move, treat, analyze, and return water to the environment, and we help people use water efficiently, in their homes, buildings, factories and farms. In more than 150 countries, we have strong, long-standing relationships with customers who know us for our powerful combination of leading product brands and applications expertise, backed by a legacy of innovation.

For more information on how Xylem can help you, go to www.xylem.com



Wissenschaftlich-Technische Werkstätten GmbH

Dr.-Karl-Slevogt-Straße 1
D-82362 Weilheim
Germany

Tel: +49 881 183-0
Fax: +49 881 183-420
E-Mail: info@wtw.com
Internet: www.wtw.com