

# pH 3310 IDS

DIGITAL METER FOR DIGITAL IDS-pH AND ORP SENSORS



a xylem brand



The latest version of the present operating manual is available on the Internet under [www.WTW.com](http://www.WTW.com).

**Copyright**

© 2014, WTW GmbH

Reproduction in whole - or even in part - is prohibited without the express written permission of WTW GmbH, Weilheim.

Printed in Germany.

## pH 3310 IDS - Contents

<b>1</b>	<b>Overview</b>	<b>7</b>
1.1	pH 3310 IDS meter	7
1.2	Sensors	7
1.2.1	IDS sensors	8
1.2.2	Automatic sensor recognition	8
<b>2</b>	<b>Safety</b>	<b>10</b>
2.1	Safety information	10
2.1.1	Safety information in the operating manual	10
2.1.2	Safety signs on the meter	10
2.1.3	Further documents providing safety information	10
2.2	Safe operation	11
2.2.1	Authorized use	11
2.2.2	Requirements for safe operation	11
2.2.3	Unauthorized use	11
<b>3</b>	<b>Commissioning</b>	<b>12</b>
3.1	Scope of delivery	12
3.2	Power supply	12
3.3	Initial commissioning	12
3.3.1	Inserting the batteries	13
<b>4</b>	<b>Operation</b>	<b>14</b>
4.1	General operating principles	14
4.1.1	Keypad	14
4.1.2	Display	15
4.1.3	Status information (meter)	15
4.1.4	Connectors	16
4.1.5	Sensor info.	16
4.2	Switching on the meter	17
4.3	Switching off the meter	17
4.4	Navigation	18
4.4.1	Operating modes	18
4.4.2	Measured value display	18
4.4.3	Menus and dialogs	18
4.4.4	Navigation example 1: Setting the language	20
4.4.5	Example 2 on navigation: Setting the date and time	21

---

<b>5</b>	<b>pH value</b>	<b>23</b>
5.1	Measuring	23
5.1.1	Measuring the pH value	23
5.1.2	Measuring the temperature	24
5.2	pH calibration	25
5.2.1	Why calibrate?	25
5.2.2	When do you have to calibrate?	25
5.2.3	Carrying out automatic calibration (AutoCal)	25
5.2.4	Carrying out manual calibration (ConCal)	28
5.2.5	Calibration points	31
5.2.6	Calibration data	32
5.2.7	Continuous measurement control (CMC function)	35
5.2.8	QSC function (sensor quality control)	36
<b>6</b>	<b>ORP</b>	<b>39</b>
6.1	Measuring	39
6.1.1	Measuring the ORP	39
6.1.2	Measuring the temperature	40
6.2	ORP calibration	41
<b>7</b>	<b>Settings</b>	<b>42</b>
7.1	pH measurement settings	42
7.1.1	Settings for pH measurements	42
7.1.2	Buffer sets for calibration	43
7.1.3	Calibration interval	45
7.2	ORP measurement settings	46
7.2.1	Settings for ORP measurements	46
7.3	Sensor-independent settings	46
7.3.1	<i>System</i>	46
7.3.2	<i>Data storage</i>	47
7.3.3	<i>Automatic Stability control</i>	48
7.3.4	Automatic switch-off function	48
7.3.5	Display illumination	48
7.4	Reset	49
7.4.1	Resetting the measurement settings	49
7.4.2	Resetting the system settings	50
<b>8</b>	<b>Data memory</b>	<b>51</b>
8.1	Manual storage	51
8.2	Automatic data storage at intervals	52
8.3	Measurement data memory	54
8.3.1	Editing the measurement data memory	54
8.3.2	Erasing the measurement data memory	55
8.3.3	Measurement dataset	56
8.3.4	Storage locations	56

---

<b>9</b>	<b>Transmitting data (USB interface)</b> .....	<b>57</b>
9.1	Outputting current measurement data .....	57
9.2	Transmitting data (to a PC) .....	57
9.3	Connecting the PC / USB-B interface ( <i>USB Device</i> ) .....	57
9.4	Options for data storage to a PC .....	58
9.5	MultiLab Importer .....	58
<b>10</b>	<b>Maintenance, cleaning, disposal</b> .....	<b>59</b>
10.1	Maintenance .....	59
10.1.1	General maintenance activities .....	59
10.1.2	Replacing the batteries .....	59
10.2	Cleaning .....	60
10.3	Packing .....	60
10.4	Disposal .....	60
<b>11</b>	<b>What to do if</b> .....	<b>61</b>
11.1	pH .....	61
11.2	General information .....	62
<b>12</b>	<b>Technical data</b> .....	<b>64</b>
12.1	Measuring ranges, resolution, accuracy .....	64
12.2	General data .....	64
<b>13</b>	<b>Firmware update</b> .....	<b>66</b>
13.1	Firmware update for the meter pH 3310 IDS .....	66
13.2	Firmware-Update for IDS Sensors .....	67
<b>14</b>	<b>Glossary</b> .....	<b>68</b>
<b>15</b>	<b>Index</b> .....	<b>71</b>



# 1 Overview

## 1.1 pH 3310 IDS meter

The pH 3310 IDS digital compact precision pH meter enables you to perform pH and ORP measurements rapidly and reliably.

The pH 3310 IDS provides the maximum degree of operating comfort, reliability and measuring certainty for all applications.

The pH 3310 IDS supports you in your work with the following functions:

- Automatic sensor recognition
- Electronic access control
- Data transmission via the USB interface (USB-B).

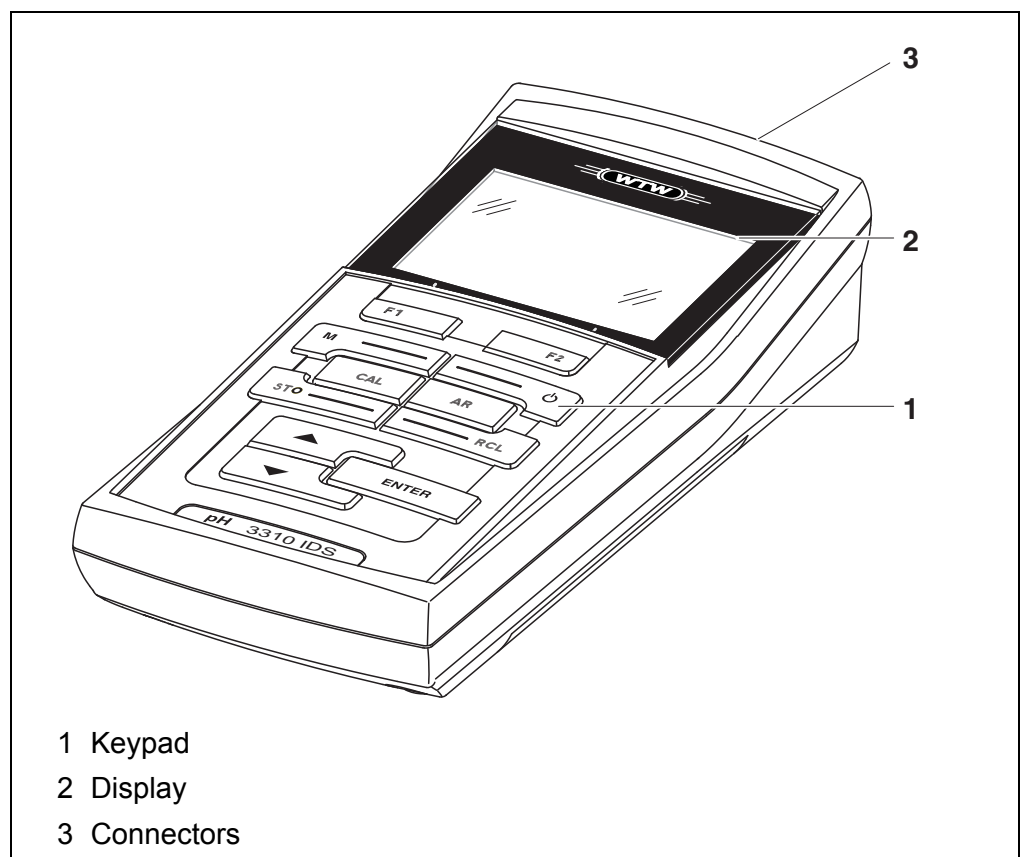

## 1.2 Sensors

A measuring system ready to measure consists of the pH 3310 IDS meter and a suitable sensor.

Suitable sensors are WTW IDS pH and ORP sensors.



Information on available IDS sensors is given on the Internet and in the WTW catalog, "Laboratory and field instrumentation".

### 1.2.1 IDS sensors

IDS sensors

- support the automatic sensor recognition
- show only the settings relevant to the specific sensor in the setting menu
- process signals in the sensor digitally so that precise and interference-free measurements are enabled even with long cables
- facilitate to assign a sensor to a measured parameter with differently colored couplings
- have quick-lock couplings with which to fix the sensors to the meter.

#### Sensor data from IDS sensors

IDS sensors transmit the following sensor data to the meter:

- SENSOR ID
  - Sensor name
  - Sensor series number
- Calibration data
  - Calibration date
  - Calibration characteristics
  - Calibration interval
  - Selected buffer set (IDS pH sensors only)
  - Calibration history of the last 10 calibrations

The calibration data are updated in the IDS sensor after each calibration procedure. A message is displayed while the data are being updated in the sensor.



#### Note

In the measured value display, you can display the sensor name and series number of the selected sensor with the [Info] softkey. You can then display all further sensor data stored in the sensor with the [More] softkey.

### 1.2.2 Automatic sensor recognition

The automatic sensor recognition for IDS sensors allows

- to operate an IDS sensor with different meters without recalibrating
- to assign measurement data to an IDS sensor
  - Measurement datasets are always stored and output with the sensor name and sensor series number.
- to assign calibration data to an IDS sensor
  - Calibration data and calibration history are always stored and output with the sensor name and sensor series number.
- to hide menus automatically that do not concern this sensor



To be able to use the automatic sensor recognition, a meter that supports the automatic sensor recognition (e.g. pH 3310 IDS) and a digital IDS sensor are required.

In digital IDS sensors, sensor data are stored that clearly identify the sensor. The sensor data are automatically taken over by the meter.

## 2 Safety

### 2.1 Safety information

#### 2.1.1 Safety information in the operating manual

This operating manual provides important information on the safe operation of the meter. Read this operating manual thoroughly and make yourself familiar with the meter before putting it into operation or working with it. The operating manual must be kept in the vicinity of the meter so you can always find the information you need.

Important safety instructions are highlighted in this operating manual. They are indicated by the warning symbol (triangle) in the left column. The signal word (e.g. "CAUTION") indicates the level of danger:

**WARNING**

indicates a possibly dangerous situation that can lead to serious (irreversible) injury or death if the safety instruction is not followed.

**CAUTION**

indicates a possibly dangerous situation that can lead to slight (reversible) injury if the safety instruction is not followed.

**NOTE**

indicates a possibly dangerous situation where goods might be damaged if the actions mentioned are not taken.

#### 2.1.2 Safety signs on the meter

Note all labels, information signs and safety symbols on the meter and in the battery compartment. A warning symbol (triangle) without text refers to safety information in this operating manual.

#### 2.1.3 Further documents providing safety information

The following documents provide additional information, which you should observe for your safety when working with the measuring system:

- Operating manuals of sensors and other accessories
- Safety datasheets of calibration or maintenance accessories (such as buffer solutions, electrolyte solutions, etc.)

## **2.2 Safe operation**

### **2.2.1 Authorized use**

This meter is authorized exclusively for pH and ORP measurements in the laboratory.

Only the operation and running of the meter according to the instructions and technical specifications given in this operating manual is authorized (see section 12 TECHNICAL DATA, page 64).

Any other use is considered unauthorized.

### **2.2.2 Requirements for safe operation**

Note the following points for safe operation:

- The meter may only be operated according to the authorized use specified above.
- The meter may only be supplied with power by the energy sources mentioned in this operating manual.
- The meter may only be operated under the environmental conditions mentioned in this operating manual.
- The meter may only be opened if this is explicitly described in this operating manual (example: Inserting the batteries).

### **2.2.3 Unauthorized use**

The meter must not be put into operation if:

- it is visibly damaged (e.g. after being transported)
- it was stored under adverse conditions for a lengthy period of time (storing conditions, see section 12 TECHNICAL DATA, page 64).

## 3 Commissioning

### 3.1 Scope of delivery

- Meter pH 3310 IDS
- 4 batteries 1.5 V Mignon type AA
- USB cable (A plug on mini B plug)
- Short instructions
- CD-ROM with
  - USB drivers
  - detailed operating manual
  - Software MultiLab Importer

### 3.2 Power supply

The pH 3310 IDS is supplied with power in the following ways:

- Battery operation (4 batteries, 1.5 V Mignon type AA)
- USB operation via a connected USB-B cable

### 3.3 Initial commissioning

Perform the following activities:

- Insert the supplied batteries
- Switch on the meter (see section 4.2 SWITCHING ON THE METER, page 17)
- Set the date and time (see section 4.4.5 EXAMPLE 2 ON NAVIGATION: SETTING THE DATE AND TIME, page 21)

### 3.3.1 Inserting the batteries

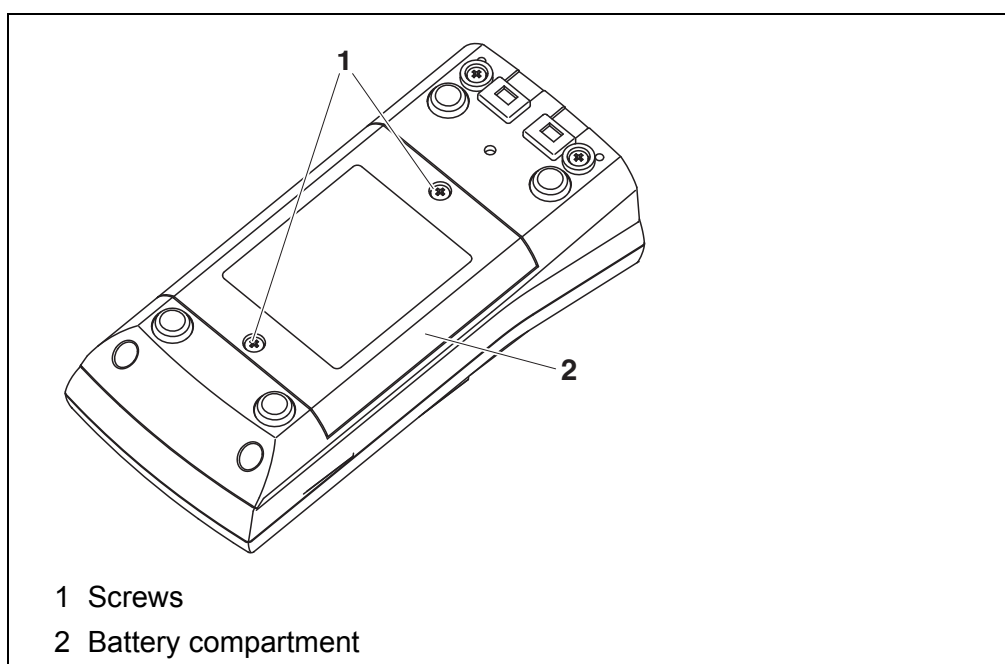

1. Open the battery compartment (1) on the underside of the meter.

**CAUTION**

**Make sure that the poles of the batteries are positioned correctly.**

**The ± signs on the batteries must correspond to the ± signs in the battery compartment.**



You can operate the meter either with normal batteries or with rechargeable batteries (Ni-MH). In order to charge the batteries, an external charging device is required.

2. Place four batteries (type Mignon AA) in the battery compartment.
3. Close the battery compartment (1).
4. Set the date and time  
(see section 4.4.5 EXAMPLE 2 ON NAVIGATION: SETTING THE DATE AND TIME, page 21).









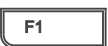

## 4 Operation

### 4.1 General operating principles

#### 4.1.1 Keypad

In this operating manual, keys are indicated by brackets <.> .

The key symbol (e.g. <ENTER>) generally indicates a short keystroke (under 2 sec) in this operating manual. A long keystroke (approx. 2 sec) is indicated by the underscore behind the key symbol (e.g. <ENTER\_>).

 	<F1>: <F1_>: <F2>: <F2_>:	Softkeys providing situation dependent functions, e.g.: <F1>/[Info]: View information on a sensor
	<On/Off>:	Switches the meter on or off
	<M>:	Selects the measured parameter / Quits the settings
	<CAL>: <CAL_>:	Calls up the calibration procedure Displays the calibration data
	<STO>: <STO_>:	Saves a measured value manually Opens the menu for the automatic save function
	<RCL>: <RCL_>:	Displays the manually stored measured values Displays the automatically stored measured values
 	<▲><▼>: <▲_><▼_>:	Menu control, navigation Increments, decrements values Increments, decrements values continuously
	<ENTER>: <ENTER_>:	Opens the menu for measurement settings / confirms entries Opens the menu for system settings
	<AR>	Freezes the measured value (HOLD function) Switches the AutoRead measurement on or off

### 4.1.2 Display

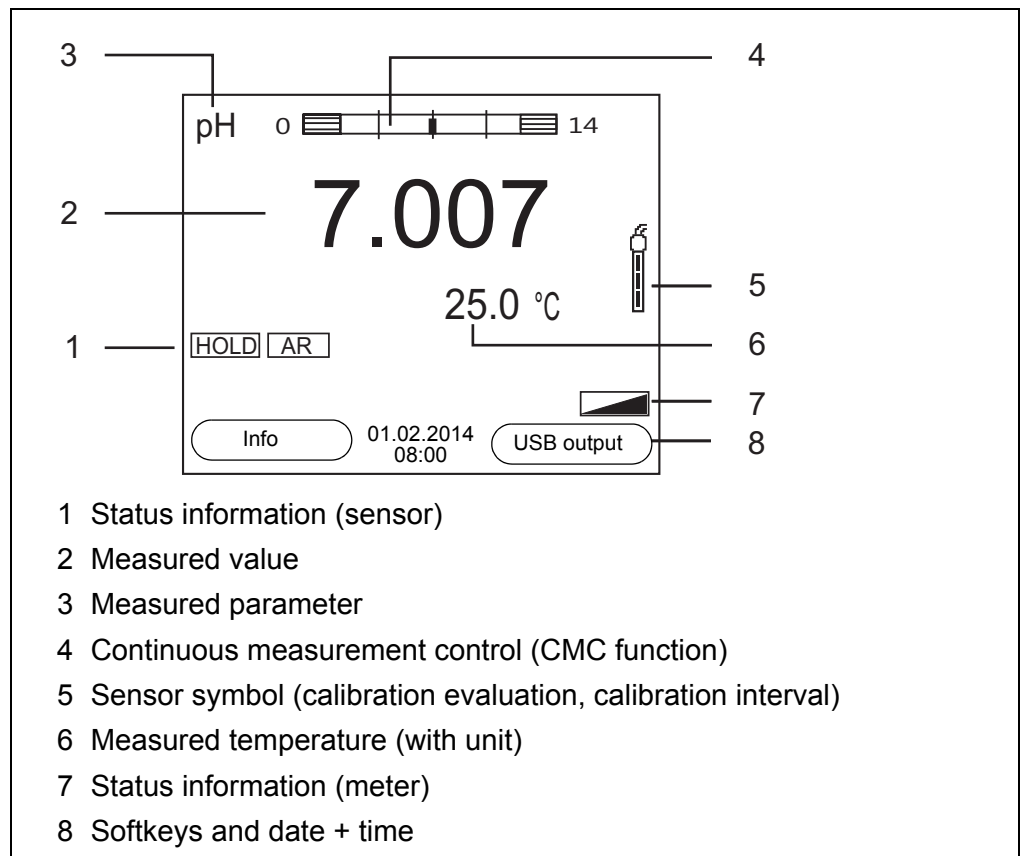

### 4.1.3 Status information (meter)

AR	Stability control (AutoRead) is active
HOLD	Measured value is frozen (<AR> key)
	Batteries are almost empty
	Data are automatically output to the USB-B interface at intervals

#### 4.1.4 Connectors

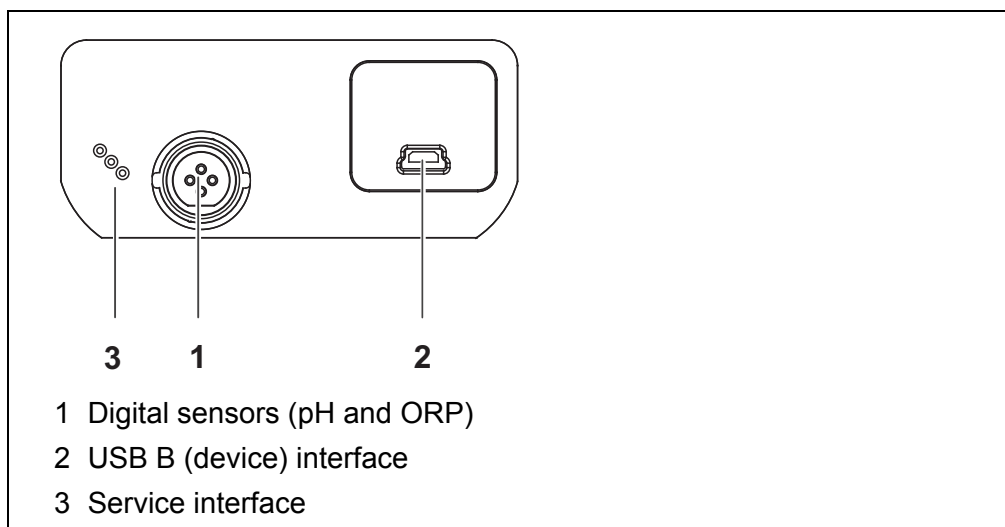

#### CAUTION

Only connect sensors to the meter that cannot return any voltages or currents that are not allowed (> SELV and > current circuit with current limiting).

WTW IDS sensors and IDS adapters meet these requirements.

#### 4.1.5 Sensor info

You can display the current sensor data and sensor settings of a connected sensor at any time. The sensor data are available in the measured value display with the <F1>/[Info] softkey.

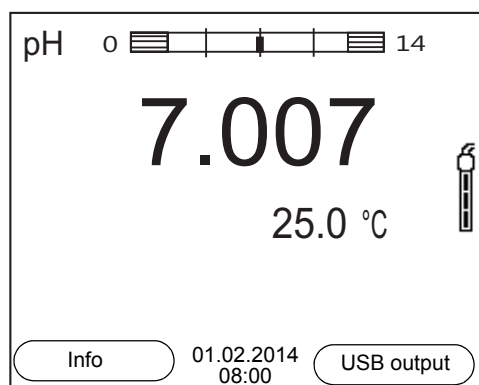

1. In the measured value display:  
Display the sensor data (sensor name, series number) with [<F1>Info].



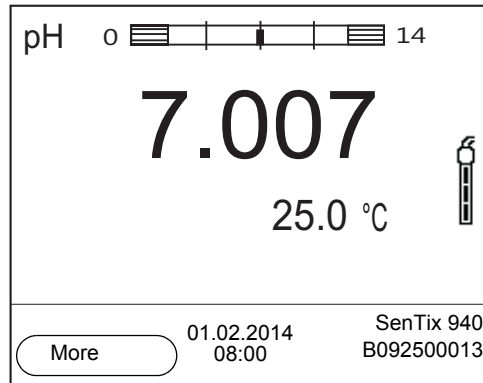

2. Display further sensor data (settings) with **<F1>/[More]**.

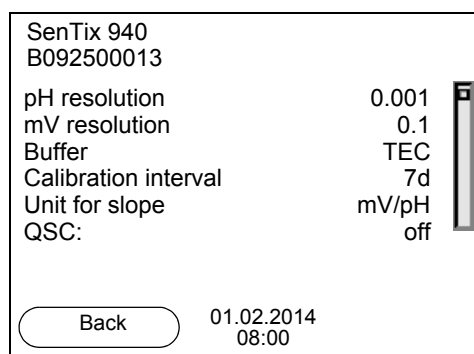

## 4.2 Switching on the meter

1. Switch the meter on with **<On/Off>**.  
The meter performs a self-test.
2. Connect the sensor.  
The meter is ready to measure.

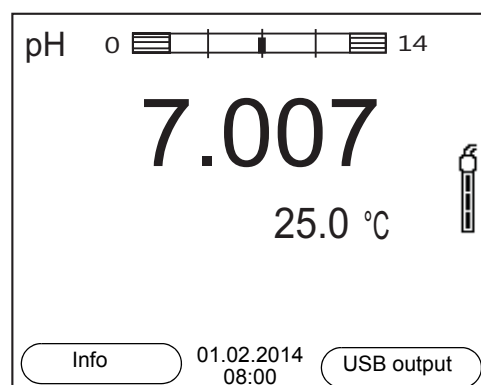

## 4.3 Switching off the meter

1. Switch the printer off with **<On/Off>**.

## 4.4 Navigation

### 4.4.1 Operating modes

Operating mode	Explanation
<b>Measuring</b>	The measurement data of the connected sensor are shown in the measured value display
<b>Calibration</b>	The course of a calibration with calibration information, functions and settings is displayed
<b>Storing in memory</b>	The meter stores measuring data automatically or manually
<b>Transmitting data</b>	The meter transmits measuring data and calibration records to a USB-B interface automatically or manually.
<b>Setting</b>	The system menu or a sensor menu with submenus, settings and functions is displayed

### 4.4.2 Measured value display

In the measured value display, you can

- open the menu for calibration and measurement settings with **<ENTER>** (short keystroke)
- **<ENTER\_>** open the *Storage & config* menu with the sensor-independent settings by pressing **<ENTER>** (long keystroke, approx. 2 s).
- change the display in the selected measuring screen (e. g. pH <-> mV) by pressing **<M>**.

### 4.4.3 Menus and dialogs

The menus for settings and dialogs in procedures contain further subelements. The selection is made with the **<▲><▼>** keys. The current selection is displayed with a frame.

- Submenus

The name of the submenu is displayed at the upper edge of the frame. Submenus are opened by confirming with **<ENTER>**. Example:

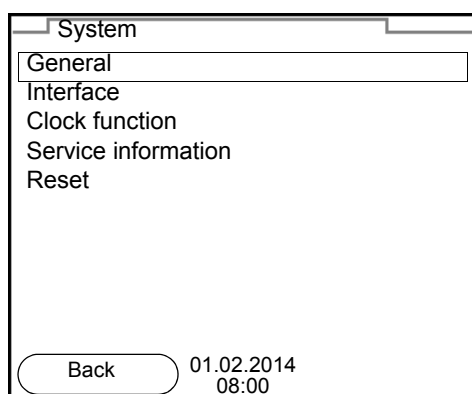

- **Settings**

Settings are indicated by a colon. The current setting is displayed on the right-hand side. The setting mode is opened with **<ENTER>**. Subsequently, the setting can be changed with **<▲><▼>** and **<ENTER>**. Example:

General	
Language:	Deutsch
Audio signal:	off
Illumination:	on
Contrast:	50 %
Shutoff time:	1 h
Temperature unit:	°C
Stability control:	on
<input type="button" value="Back"/> 01.02.2014 08:00	

- **Functions**

Functions are designated by the name of the function. They are immediately carried out by confirming with **<ENTER>**. Example: Display the *Calibration record* function.

pH	
Calibration record	
Calibration data storage	
Buffer:	TEC
Single-point calibration:	yes
Calibration interval:	7 d
Unit for slope:	mV/pH
[ $\pm$ ]2.00 4.01 7.00 10.01	
<input type="button" value="Back"/> 01.02.2014 08:00	

- **Messages**

Information is marked by the [ $\pm$ ] symbol. It cannot be selected. Example:

pH	
Calibration record	
Calibration data storage	
Buffer:	TEC
Single-point calibration:	yes
Calibration interval:	7 d
Unit for slope:	mV/pH
[ $\pm$ ]2.00 4.01 7.00 10.01	
<input type="button" value="Back"/> 01.02.2014 08:00	

#### 4.4.4 Navigation example 1: Setting the language

1. Press the **<On/Off>** key.  
The measured value display appears.  
The instrument is in the measuring mode.

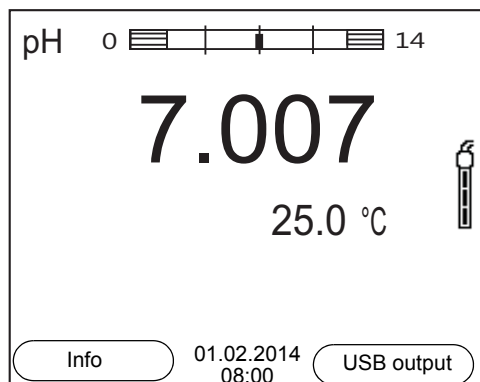

2. Using **<ENTER\_>**, open the *Storage & config* menu.  
The instrument is in the setting mode.

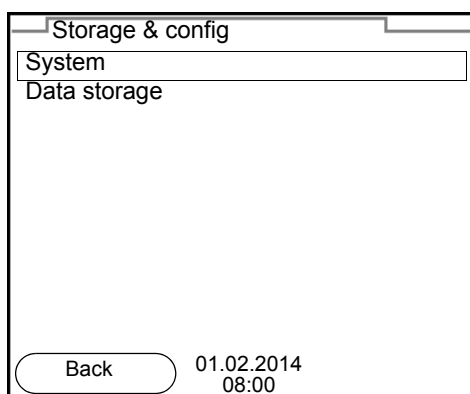

3. Select the *System* submenu with **<▲><▼>**.  
The current selection is displayed with a frame.
4. Open the *System* submenu with **<ENTER>**.

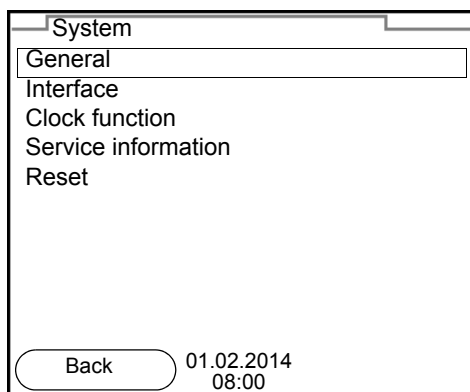

5. Select the *General* submenu with  $\langle \blacktriangle \rangle \langle \blacktriangledown \rangle$ .  
The current selection is displayed with a frame.
6. Open the *General* submenu with  $\langle \text{ENTER} \rangle$ .

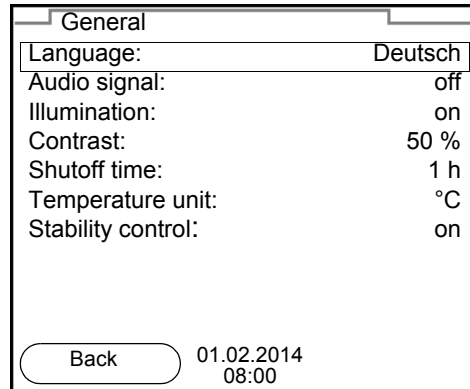

7. Open the setting mode for the *Language* with  $\langle \text{ENTER} \rangle$ .

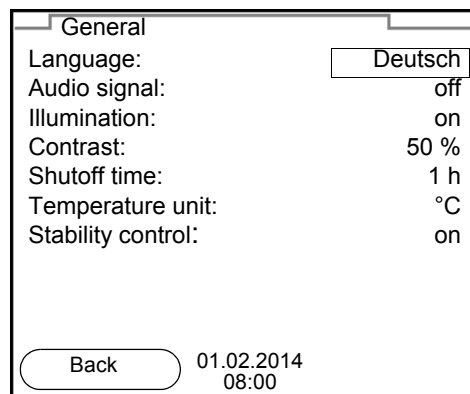

8. Select the required language with  $\langle \blacktriangle \rangle \langle \blacktriangledown \rangle$ .
9. Confirm the setting with  $\langle \text{ENTER} \rangle$ .  
The meter switches to the measuring mode.  
The selected language is active.

#### 4.4.5 Example 2 on navigation: Setting the date and time

The meter has a clock with a date function. The date and time are indicated in the status line of the measured value display.

When storing measured values and calibrating, the current date and time are automatically stored as well.

The correct setting of the date and time and date format is important for the following functions and displays:

- Current date and time
- Calibration date

- Identification of stored measured values.

Therefore, check the time at regular intervals.



The date and time are reset to default after a fall of the supply voltage (empty batteries).

### Setting the date, time and date format

The date format can be switched from the display of day, month, year (*dd.mm.yy*) to the display of month, day, year (*mm/dd/yy* or *mm.dd.yy*).

1. In the measured value display:  
Using **<ENTER\_>**, open the *Storage & config* menu.  
The instrument is in the setting mode.
2. Select and confirm the *System / Clock function* menu with **<▲><▼>** and **<ENTER>**.  
The setting menu for the date and time opens up.

Clock function	
Date format:	dd.mm.yy
Date:	01.02.14
Time:	14:53:40
<div style="display: flex; justify-content: space-between; align-items: center;"> <span>Back</span> <span>01.02.2014 08:00</span> </div>	

3. Select and confirm the *Time* menu with **<▲><▼>** and **<ENTER>**.  
The hours are highlighted.
4. Change and confirm the setting with **<▲><▼>** and **<ENTER>**.  
The minutes are highlighted.
5. Change and confirm the setting with **<▲><▼>** and **<ENTER>**.  
The seconds are highlighted.
6. Change and confirm the setting with **<▲><▼>** and **<ENTER>**.  
The time is set.
7. If necessary, set the *Date* and *Date format*. The setting is made similarly to that of the time.
8. To make further settings, switch to the next higher menu level with **Back<F1>**.  
or  
Switch to the measured value display with **<M>**.  
The instrument is in the measuring mode.

## 5 pH value

### 5.1 Measuring

#### 5.1.1 Measuring the pH value

##### NOTE

When connecting a grounded PC/printer, measurements cannot be performed in grounded media as the values would be incorrect. The USB interface is not galvanically isolated.

1. Connect the IDS pH sensor to the meter.  
The pH measuring window is displayed.
2. If necessary, select the measured parameter with **<M>**.
3. Adjust the temperature of the solutions and measure the current temperature if the measurement is made without a temperature sensor.
4. If necessary, calibrate or check the IDS pH sensor.
5. Immerse the IDS pH sensor in the test sample.

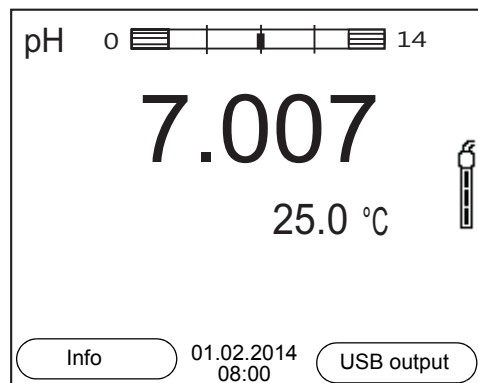

#### Stability control (AutoRead) & HOLD function

The stability control function (*AutoRead*) continually checks the stability of the measurement signal. The stability has a considerable impact on the reproducibility of measured values.

The measured parameter flashes on the display

- as soon as the measured value is outside the stability range
- when the automatic *Stability control* is switched off.

You can start the *Stability control* manually at any time, irrespective of the setting for automatic *Stability control* (see section 7.3.3 AUTOMATIC STABILITY CONTROL, page 48) in the *System* menu.

1. Freeze the measured value with **<AR>**.  
The [HOLD] status indicator is displayed.  
The HOLD function is active.



You can terminate the *Stability control* function and the HOLD function with **<AR>** or **<M>** at any time.

2. Using **<ENTER>**, activate the *Stability control* function manually. The [AR] status indicator appears while the measured value is assessed as not stable. A progress bar is displayed and the display of the measured parameter flashes. The [HOLD][AR] status indicator appears as soon as a stable measured value is recognized. The progress bar disappears and the display of the measured parameter stops flashing. The current measurement data are output to the interface. Measurement data meeting the stability control criterion are marked by AR.



You can prematurely terminate the *Stability control* function manually with **<ENTER>** at any time. If the *Stability control* function is prematurely terminated, the current measurement data are output to the interface without the AutoRead info.

3. Using **<ENTER>**, start a further measurement with stability control.  
or  
Release the frozen measured value again with **<AR>** or **<M>**. The [AR] status display disappears. The display switches back to the previous indication.

#### Criteria for a stable measured value

The *Stability control* function checks whether the measured values are stable within the monitored time interval.

Measured parameter	Time interval	Stability in the time interval
pH value	15 seconds	$\Delta$ : better than 0.01 pH
Temperature	15 seconds	$\Delta$ : better than 0.5 °C

The minimum duration until a measured value is assessed as stable is the monitored time interval. The actual duration is mostly longer.

### 5.1.2 Measuring the temperature

For reproducible pH measurements, it is essential to measure the temperature of the test sample.

Most IDS sensors measure the temperature with a temperature sensor integrated in the IDS sensor.

When operating a sensor without integrated temperature sensor, e.g. via an IDS pH adapter, you have to measure and enter the temperature of the test sample first.





The settings for the temperature are selected in the menu for calibration and measurement settings (see section 7.1.1 SETTINGS FOR PH MEASUREMENTS, page 42).

The display of the temperature indicates the active temperature measuring mode:

Temperature sensor	Resolution of the temp. display	Temp. measurement
yes	0.1 °C	Automatic with temperature sensor
-	1 °C	Manual

## 5.2 pH calibration

### 5.2.1 Why calibrate?

pH electrodes age. This changes the zero point (asymmetry) and slope of the pH electrode. As a result, an inexact measured value is displayed. Calibration determines and stores the current values of the zero point and slope of the electrode.

Thus, you should calibrate at regular intervals.

### 5.2.2 When do you have to calibrate?

- Routinely within the framework of the company quality assurance
- When the calibration interval has expired

### 5.2.3 Carrying out automatic calibration (AutoCal)

Make sure that in the sensor menu, *Buffer* menu, the buffer set is correctly selected (see section 7.1.1 SETTINGS FOR PH MEASUREMENTS, page 42).

Use one to five buffer solutions of the selected buffer set in any order.

Below, calibration with Technical buffers (TEC) is described. When other buffer sets are used, other nominal buffer values are displayed. Apart from that, the procedure is identical.



If single-point calibration was set in the menu, the calibration procedure is automatically finished with the measurement of buffer solution 1 and the calibration record is displayed.

1. Connect the pH sensor to the meter.  
The pH measuring window is displayed.
2. Keep the buffer solutions ready.

3. Start the calibration with **<CAL>**.  
The calibration display for the first buffer appears (voltage display).

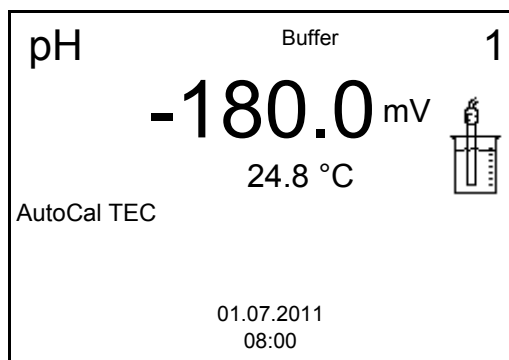

4. Thoroughly rinse the sensor with deionized water.
5. Immerse the sensor in the first buffer solution.
6. For measurements without temperature sensor :  
Enter the temperature of the buffer with **<▲><▼>**.
7. Start the measurement with **<ENTER>**.  
The measured value is checked for stability (stability control).  
The [AR] status indicator is displayed. The measured parameter flashes.

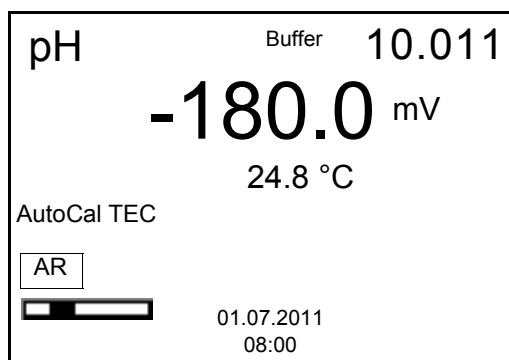

8. Wait for the end of the measurement with stability control or accept the calibration value with **<ENTER>**.  
The calibration display for the next buffer appears (voltage display).
9. If necessary, finish the calibration procedure as a single-point calibration with **<M>**.  
The calibration record is displayed.



For **single-point calibration**, the instrument uses the Nernst slope (-59.2 mV/pH at 25 °C) and determines the zero point of the IDS pH sensor.

**Continuing with two-point calibration**

10. Thoroughly rinse the sensor with deionized water.
11. Immerse the pH sensor in buffer solution 2.
12. When measuring without temperature sensor:  
Enter the temperature of the buffer with <▲><▼>.
13. Start the measurement with <ENTER>.  
The measured value is checked for stability (stability control).  
The [AR] status indicator is displayed. The measured parameter flashes.

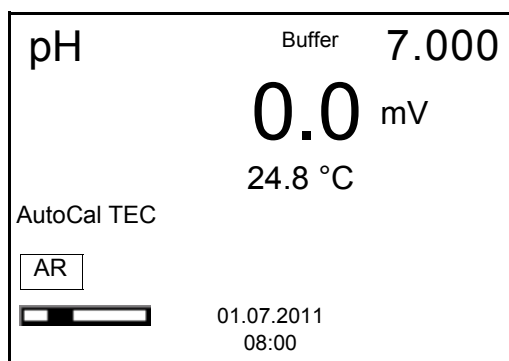

14. Wait for the measurement with stability control to be completed or terminate the stability control and take over the calibration value with <ENTER>.  
The calibration display for the next buffer appears (voltage display).
15. If necessary, finish the calibration procedure as a two-point calibration with <M>.  
The calibration record is displayed.

**Continuing with three- to five-point calibration**

16. Thoroughly rinse the sensor with deionized water.
17. Immerse the sensor in the next buffer solution.
18. When measuring without temperature sensor:  
Enter the temperature of the buffer with <▲><▼>.
19. Start the measurement with <ENTER>.  
The measured value is checked for stability (stability control).  
The [AR] status indicator is displayed. The measured parameter flashes.

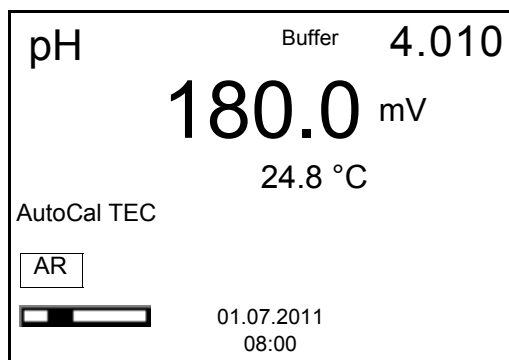

20. Wait for the measurement with stability control to be completed or terminate the stability control and take over the calibration value with **<ENTER>**.  
The calibration display for the next buffer appears (voltage display).
21. If necessary, use **<M>** to finish the calibration.  
The calibration record is displayed.  
or  
Switch to calibration with the next buffer with **<ENTER>**.



Calibration is automatically completed after the last buffer of a buffer set has been measured. Then the calibration record is displayed.

The calibration line is determined by linear regression.

#### 5.2.4 Carrying out manual calibration (ConCal)

Make sure that in the sensor menu, *Buffer* menu, the *ConCal* buffer set is correctly selected (see ).section 7.1.1 SETTINGS FOR PH MEASUREMENTS, page 42

Use any one to five buffer solutions in ascending or descending order.



If single-point calibration was set in the menu, the calibration procedure is automatically finished with the measurement of buffer solution 1 and the calibration record is displayed.

1. Connect the pH sensor to the meter.  
The pH measuring window is displayed.
2. Keep the buffer solutions ready.
3. Start the calibration with **<CAL>**.  
The calibration display for the first buffer appears (voltage display).

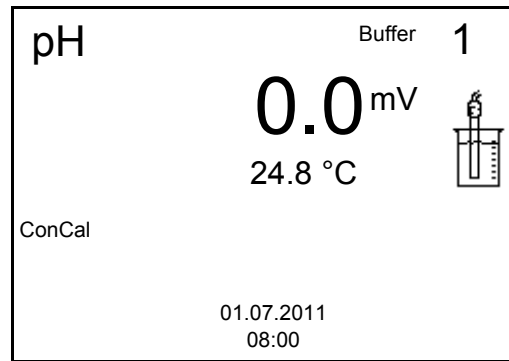

4. Thoroughly rinse the sensor with deionized water.
5. Immerse the pH sensor in buffer solution 1.
6. For measurements without temperature sensor :  
Enter the temperature of the buffer with <▲><▼>.
7. Start the measurement with <ENTER>.  
The measured value is checked for stability (stability control).  
The [AR] status indicator is displayed. The measured parameter flashes.

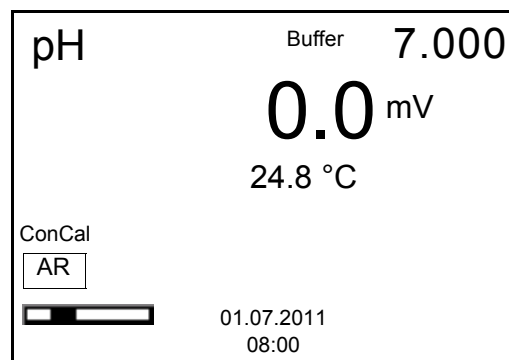

8. Wait for the measurement with stability control to be completed or terminate the stability control and take over the calibration value with <ENTER>.  
The pH value of the buffer solution is displayed.

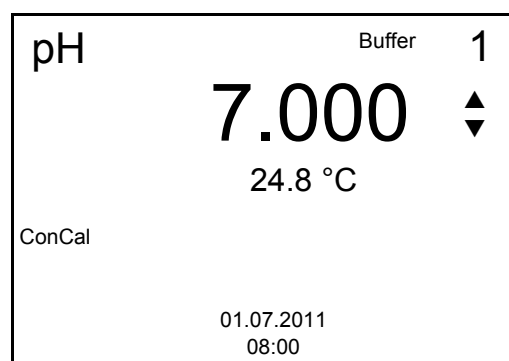

9. Set the nominal buffer value for the measured temperature with <▲><▼>.

10. Accept the calibration value with **<ENTER>**.  
The calibration display for the next buffer appears (voltage display).
11. If necessary, finish the calibration procedure as a single-point calibration with **<M>**.  
The calibration record is displayed.



For **single-point calibration**, the instrument uses the Nernst slope (-59.2 mV/pH at 25 °C) and determines the zero point of the IDS pH sensor.

### Continuing with two-point calibration

12. Thoroughly rinse the sensor with deionized water.
13. Immerse the pH sensor in buffer solution 2.
14. When measuring without temperature sensor:  
Enter the temperature of the buffer with **<▲><▼>**.
15. Start the measurement with **<ENTER>**.  
The measured value is checked for stability (stability control).  
The [AR] status indicator is displayed. The measured parameter flashes.
16. Wait for the measurement with stability control to be completed or terminate the stability control and take over the calibration value with **<ENTER>**.  
The pH value of the buffer solution is displayed.

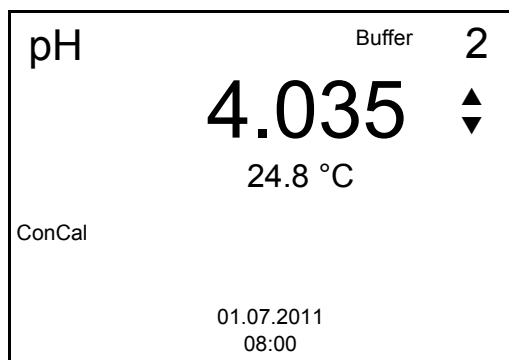

17. Set the nominal buffer value for the measured temperature with **<▲><▼>**.
18. Accept the calibration value with **<ENTER>**.  
The calibration display for the next buffer appears (voltage display).
19. If necessary, finish the calibration procedure as a two-point calibration with **<M>**.  
The calibration record is displayed.

### Continuing with three- to five-point calibration

20. Thoroughly rinse the sensor with deionized water.
21. Immerse the sensor in the next buffer solution.
22. When measuring without temperature sensor:  
Enter the temperature of the buffer with <▲><▼>.
23. Start the measurement with <ENTER>.  
The measured value is checked for stability (stability control).  
The [AR] status indicator is displayed. The measured parameter flashes.
24. Wait for the measurement with stability control to be completed or terminate the stability control and take over the calibration value with <ENTER>.  
The pH value of the buffer solution is displayed.

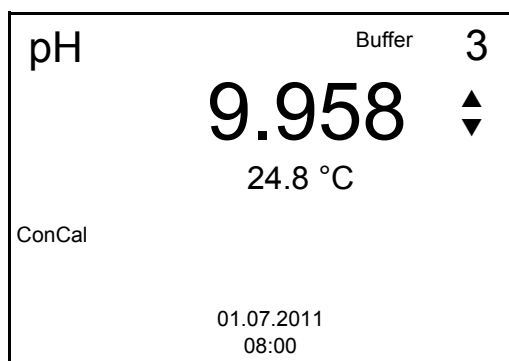

25. Set the nominal buffer value for the measured temperature with <▲><▼>.
26. Accept the calibration value with <ENTER>.  
The calibration display for the next buffer appears (voltage display).
27. If necessary, use <M> to finish the calibration.  
The calibration record is displayed.  
or  
Continue calibrating using the next buffer with <ENTER>.



After the fifth buffer has been measured the calibration is automatically finished. Then the calibration record is displayed.

The calibration line is determined by linear regression.

### 5.2.5 Calibration points

Calibration can be performed using one to five buffer solutions in any order (single-point to five-point calibration). The meter determines the following values and calculates the calibration line as follows:

Calibration	Determined values	Displayed calibration data
1-point	<i>Asy</i>	<ul style="list-style-type: none"> <li>● Zero point = <i>Asy</i></li> <li>● Slope = Nernst slope (-59.2 mV/pH at 25 °C)</li> </ul>
2-point	<i>Asy</i> <i>Slp.</i>	<ul style="list-style-type: none"> <li>● Zero point = <i>Asy</i></li> <li>● Slope = <i>Slp.</i></li> </ul>
3-point to 5-point	<i>Asy</i> <i>Slp.</i>	<ul style="list-style-type: none"> <li>● Zero point = <i>Asy</i></li> <li>● Slope = <i>Slp.</i></li> </ul> <p>The calibration line is calculated by linear regression.</p>



You can display the slope in the units, mV/pH or % (see section 7.1.1 SETTINGS FOR PH MEASUREMENTS, page 42).

### 5.2.6 Calibration data



The calibration record is automatically transmitted to the interface after calibrating.

#### Displaying the calibration data

The calibration record of the last calibration is to be found under the menu item, *Calibration / Calibration record*. To open it in the measured value display, press the **<CAL\_>** key.





The calibration records of the last 10 calibrations are to be found in the menu, *Calibration / Calibration data storage / Display*. To open the *Calibration* menu, press the **<ENTER>** key in the measured value display.



Menu item	Setting/function	Explanation
<i>Calibration / Calibration data storage / Display</i>	-	Displays the calibration records. Further options: <ul style="list-style-type: none"> <li>● Scroll through the calibration records with &lt;▲&gt;&lt;▼&gt;.</li> <li>● Output the displayed calibration record to the interface with &lt;F2&gt;/[USB output].</li> <li>● Output all calibration records to the interface with &lt;F2__&gt;[USB output].</li> <li>● Quit the display with &lt;F1&gt;/[Back] or &lt;ENTER&gt;.</li> <li>● Switch directly to the measured value display with &lt;M&gt;.</li> </ul>
<i>Calibration / Calibration data storage / Output to RS232/USB</i>	-	Outputs the calibration data memory to the interface

### Calibration evaluation

After calibrating, the meter automatically evaluates the calibration. The zero point and slope are evaluated separately. The worse evaluation of both is taken into account. The evaluation appears on the display and in the calibration record.

Display	Calibration record	Zero point [mV]	Slope [mV/pH]
	+++	-15 ... +15	-60,5 ... -58,0
	++	-20 ... <-15 or >+15 ... +20	>-58.0 ... -57.0
	+	-25 ... <-20 or >+20 ... +25	-61.0 ... <-60.5 or >-57.0 ... -56.0
	-	-30 ... <-25 or >+25 ... +30	-62.0 ... <-61.0 or >-56.0 ... -50.0
Clean the IDS sensor according to the sensor operating manual			
<i>Error</i>	<i>Error</i>	<-30 or >+30	<-62.0 or > -50,0

Display	Calibration record	Zero point [mV]	Slope [mV/pH]
Error elimination (see section 14 WHAT TO DO IF..., page 88)			



For pH IDS sensors you can optionally enable a more finely graded calibration evaluation (QSC) (see section 5.2.8 QSC FUNCTION (SENSOR QUALITY CONTROL), page 36).

### Calibration record (USB output)

```

CALIBRATIONpH
01.02.2014 07:43:33

SenTix 940
Ser. no. B092500013
TEC
Buffer 1          4.01
Buffer 2          7.00
Buffer 3          10.01
Voltage 1         184.0 mV   24.0 °C
Voltage 2         3.0 mV    24.0 °C
Voltage 3         -177.0 mV  24.0 °C
Slope             -60.2 mV/pH
Asymmetry         4.0 mV
Sensor            +++

etc...

```

### 5.2.7 Continuous measurement control (CMC function)

The Continuous Measurement Control (CMC function) facilitates to evaluate the current measured value instantly and definitely.

After each successful calibration the scale of the pH measuring range is displayed in the measured value display. Here you can very clearly see whether or not the current measured value is in the calibrated part of the measuring range.

The following information is displayed:

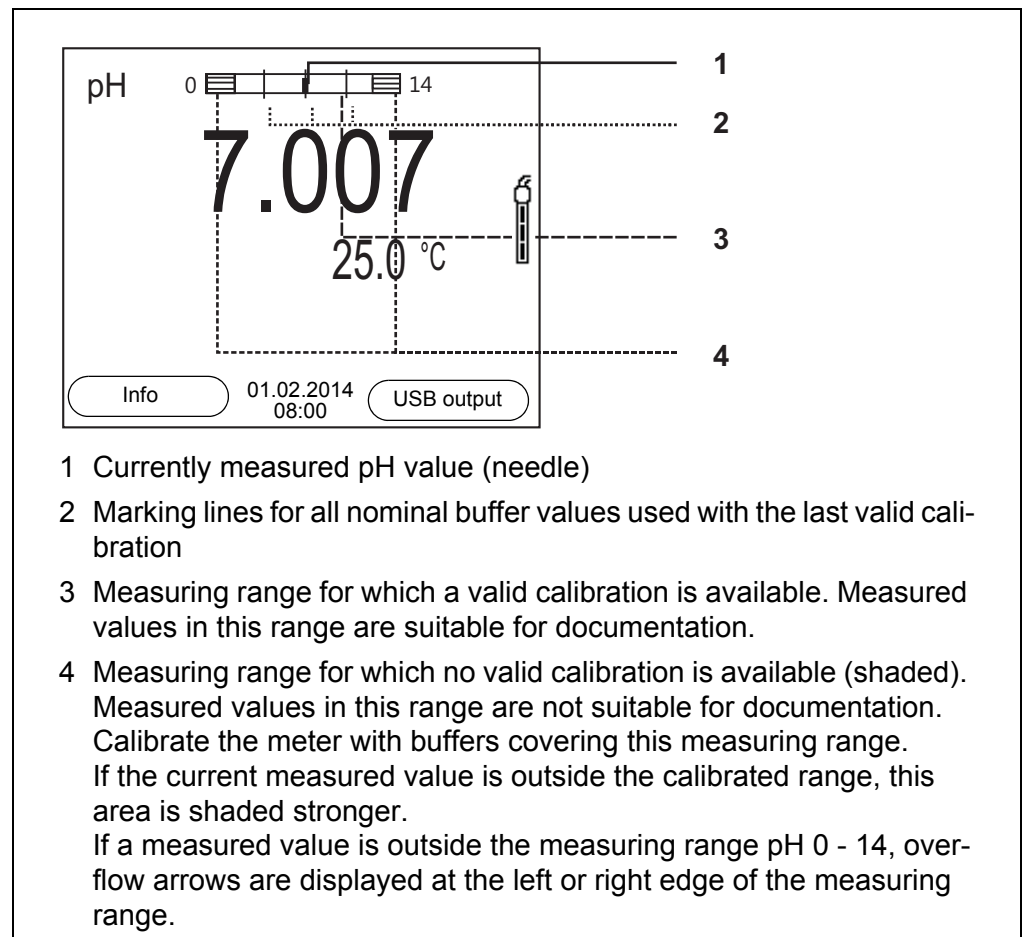

The limits of the calibrated range are determined by the buffers used for calibration:

Lower limit: Buffer with lowest pH value - 2 pH units  
 Upper limit: Buffer with highest pH value + 2 pH units

### 5.2.8 QSC function (sensor quality control)

#### General information on the QSC function

The QSC function (Quality Sensor Control) is a new sensor evaluation for digital IDS sensors. It evaluates the condition of an IDS pH sensor individually and with a very fine grading.

The QSC scale shows the current sensor evaluation with an indicator on the display.

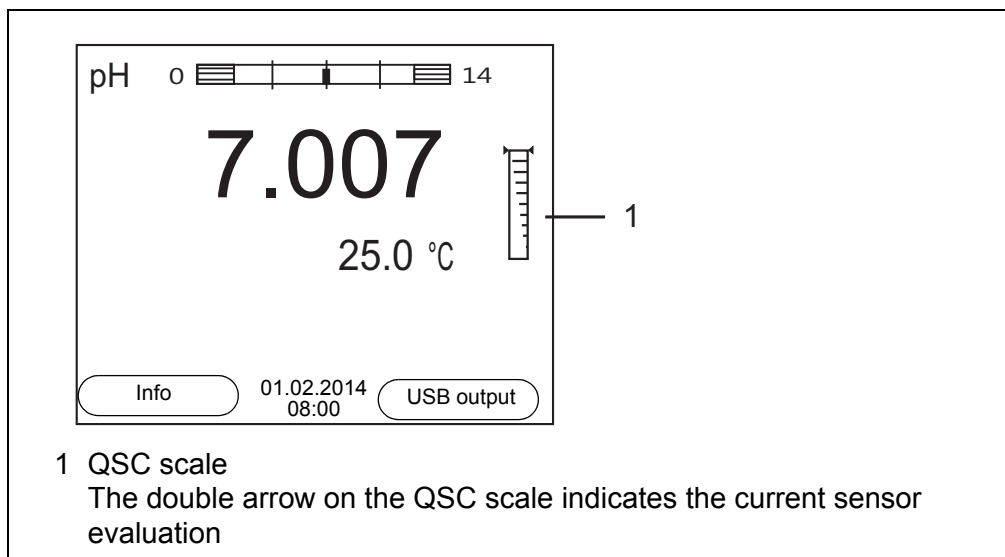

In the USB output the sensor evaluation is given as a percentage (1-100).

The finely graded sensor evaluation of the QSC function promptly calls your attention to changes of the sensor.

Thus you can do what is necessary to restore the optimum measuring quality (e.g. clean, calibrate or replace the sensor).

#### Sensor evaluation with / without QSC function

With QSC function	Without QSC function (sensor symbol)
Very fine grading of the sensor evaluation (100 grades)	Rough grading of the sensor evaluation (4 grades)
The reference value is individually determined for each sensor during the QSC initial calibration.	A theoretical reference value is used for all sensors
Low tolerances for zero point and slope when using QSC buffer solutions	Greater tolerances for zero point and slope when using commercial buffer sets
Additional QSC calibration required (with special QSC buffer set)	No additional calibration required

#### QSC calibration

The QSC function is enabled by once carrying out an additional three-point calibration with special QSC buffer solutions. It covers the measuring range of the sensor (pH 2 to pH 11). The QSC initial calibration determines the actual condition of the sensor and stores it as a reference in the sensor.

To meet the high requirements of a QSC initial calibration, the QSC initial calibration should optimally be carried out with the initial commissioning of the sensor.

Carry out the normal calibrations for your special measuring range with your usual standard solutions as previously done.



As soon as the QSC function was enabled for an IDS sensor, it is not possible to return to the sensor evaluation with the sensor symbol for this sensor.

### Carrying out a QSC initial calibration

1. Open the menu for measurement settings with **<ENTER>**.
2. In the QSC menu, select *First calibration* with **<▲><▼>**. The calibration display appears. *AutoCal QSC-Kit* is displayed as the buffer. Exclusively use the QSC-Kit for the QSC calibration. If you use other buffers, you will have no valid QSC calibration.

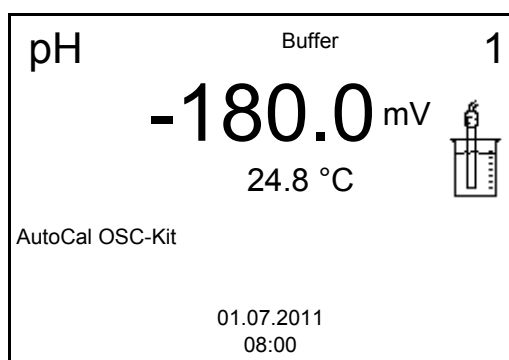

3. Calibration with the buffers of the QSC-Kit is done like a normal three-point calibration. Follow the user guide.



Carry out the QSC initial calibration very carefully. It determines the reference value for the sensor. This reference value cannot be overwritten or reset.

As soon as the QSC function was enabled, it is not possible to return to the sensor evaluation with the sensor symbol.

4. As soon as the three-point calibration has been successfully carried out you can decide whether to accept or discard the calibration as the QSC initial calibration.

The QSC initial calibration is completed. The sensor is calibrated. If you want to calibrate with special buffers for your measurements, you can subsequently carry out a normal calibration with your buffers. The reference values determined with the QSC calibration are also used for the evaluation of normal calibrations. In the measured value display, the QSC scale of the QSC function is always displayed. A double arrow on the QSC scale indicates the current sen-

sensor evaluation.

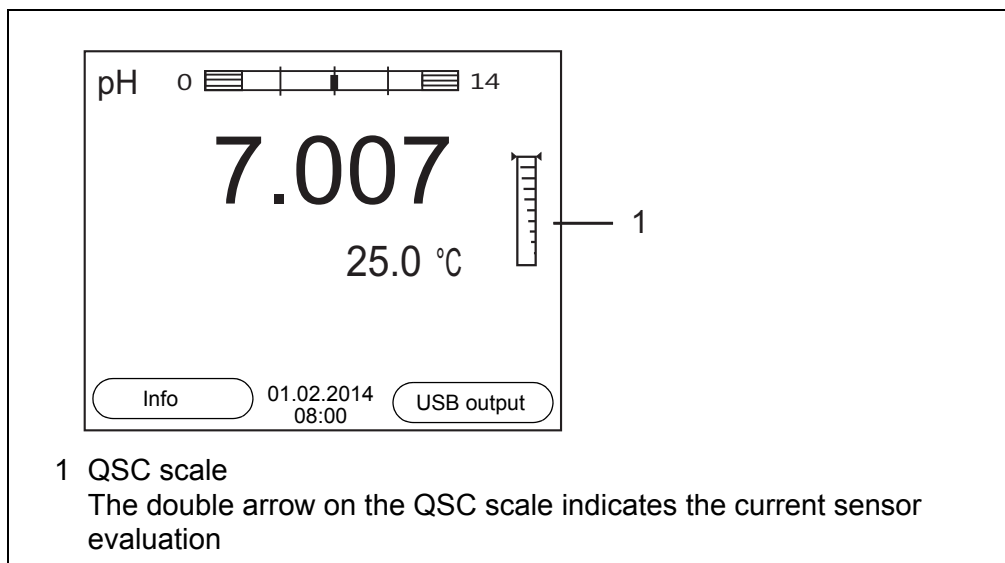

### Carrying out a QSC control calibration

A QSC control calibration can, e.g. be useful if the sensor evaluation noticeably changed (after some normal calibrations).

You can carry out QSC control calibrations at greater intervals than normal calibrations.

1. Open the menu for measurement settings with **<ENTER>**.
2. In the QSC menu, select *Control calibration* with **<▲><▼>**.  
The calibration display appears. *AutoCal QSC-Kit* is displayed as the buffer.  
Exclusively use the QSC-Kit for the QSC calibration. If you use other buffers, you will have no valid QSC control calibration.
3. Follow the user guide.  
The calibration is carried out like a normal three-point calibration. As soon as the three-point calibration has been successfully carried out you can decide whether to accept or discard the calibration as the QSC control calibration.

## 6 ORP

### 6.1 Measuring

#### 6.1.1 Measuring the ORP

##### NOTE

When connecting a grounded PC/printer, measurements cannot be performed in grounded media as the values would be incorrect. The USB interface is not galvanically isolated.



IDS ORP sensors are not calibrated. However, you can check IDS ORP sensors using a test solution.

1. Connect the ORP sensor to the meter.  
The ORP measuring window is displayed.
2. Adjust the temperature of the solutions and measure the current temperature if the measurement is made without a temperature sensor.
3. If necessary, check the ORP sensor using a check solution.
4. Immerse the ORP sensor in the test sample.

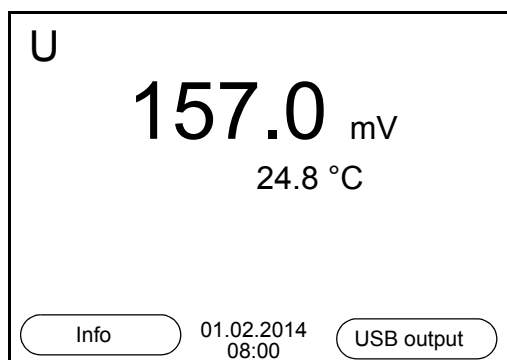

#### Stability control (AutoRead) & HOLD function

The stability control function (*AutoRead*) continually checks the stability of the measurement signal. The stability has a considerable impact on the reproducibility of measured values.

The measured parameter flashes on the display

- as soon as the measured value is outside the stability range
- when the automatic *Stability control* is switched off.

You can start the *Stability control* manually at any time, irrespective of the setting for automatic *Stability control* (see section 7.3.3 AUTOMATIC STABILITY CONTROL, page 48) in the *System* menu.

1. Freeze the measured value with **<AR>**.  
The [HOLD] status indicator is displayed.  
The HOLD function is active.



You can terminate the *Stability control* function and the HOLD function with **<AR>** or **<M>** at any time.

2. Using **<ENTER>**, activate the *Stability control* function manually. The [AR] status indicator appears while the measured value is assessed as not stable. A progress bar is displayed and the display of the measured parameter flashes. The [HOLD][AR] status indicator appears as soon as a stable measured value is recognized. The progress bar disappears and the display of the measured parameter stops flashing. The current measurement data is output to the interface. Measurement data meeting the stability control criterion are marked by AR.



You can prematurely terminate the *Stability control* function manually with **<ENTER>** at any time. If the *Stability control* function is prematurely terminated, the current measurement data are output to the interface without the AutoRead info.

3. Using **<ENTER>**, start a further measurement with stability control.  
or  
Release the frozen measured value again with **<AR>** or **<M>**. The [AR] status display disappears. The display switches back to the previous indication.

**Criteria for a stable measured value**

The *Stability control* function checks whether the measured values are stable within the monitored time interval.

Measured parameter	Time interval	Stability in the time interval
ORP	15 seconds	$\Delta$ : better than 0.3 mV
Temperature	15 seconds	$\Delta$ : better than 0.5 °C

The minimum duration until a measured value is assessed as stable is the monitored time interval. The actual duration is mostly longer.

**6.1.2 Measuring the temperature**

For reproducible ORP measurements, it is essential to measure the temperature of the test sample.

The measuring instrument recognizes whether a suitable sensor is connected and automatically switches on the temperature measurement.

The display of the temperature indicates the active temperature measuring mode:

Temperature sensor	Resolution of the temp. display	Temp. measurement
--------------------	---------------------------------	-------------------



---

yes	0.1 °C	Automatic with temperature sensor
-	1 °C	Manual

## 6.2 ORP calibration



ORP electrodes are not calibrated. You can, however, check ORP electrodes by measuring the ORP of a test solution and comparing the value with the nominal value.

## 7 Settings

### 7.1 pH measurement settings

#### 7.1.1 Settings for pH measurements

**Settings** The settings are made in the menu for calibration and measurement settings of the pH measurement. To open the settings, display the required measured parameter in the measured value display and press the **<ENTER>** key. After completing the settings, switch to the measured value display with **<M>**.

Default settings are printed in **bold**.

Menu item	Possible setting Setting	Explanation
Calibration / Calibration record	-	Displays the calibration record of the last calibration.
Calibration / Calibration data storage / Display	-	Displays the last calibration records (max. 10)
Calibration / Calibration data storage / Output to RS232/USB	-	Outputs the calibration data memory to the interface
Calibration / Buffer	<b>TEC</b> <b>ConCal</b> <b>NIST/DIN</b> ...	Buffer sets to be used for pH calibration. More buffers and details: see section 7.1.2 BUFFER SETS FOR CALIBRATION, page 43 and section 5.2 PH CALIBRATION, page 25.
Calibration / Single-point calibration	<b>yes</b> <b>no</b>	Quick calibration with 1 buffer
Calibration / Calibration interval	<b>1 ... 7 ... 999</b> <b>d</b>	<b>Calibration interval</b> for the IDS pH sensor (in days). The meter reminds you to calibrate regularly by the flashing sensor symbol in the measuring screen.
Calibration / Unit for slope	<b>mV/pH</b> <b>%</b>	Unit of the slope. The % display refers to the Nernst slope of -59.2 mV/pH (100 x determined slope/Nernst slope).
QSC / First calibration	-	Starts the initial calibration with QSC buffers. This menu item is only available as long as no initial calibration was carried out with the connected IDS sensor.
QSC / Record of first calibration	-	Displays the calibration record of the QSC initial calibration.
QSC / Control calibration	-	Starts the control calibration with QSC buffers. This menu item is only available if an initial calibration was carried out with the connected IDS sensor.
Man. temperature	<b>-25 ... +25 ...</b> <b>+130 °C</b>	Entry of the manually determined temperature.

Menu item	Possible setting Setting	Explanation
<i>pH resolution</i>	<b>0.001</b> 0.01 0.1	Resolution of the pH display
<i>mV resolution</i>	<b>0.1</b> 1	Resolution of the mV display
<i>Reset</i>	-	Resets all sensor settings to the delivery condition (see section 7.4.1 RESETTING THE MEASUREMENT SETTINGS, page 49).

### 7.1.2 Buffer sets for calibration

You can use the buffer sets quoted in the table for an automatic calibration. The pH values are valid for the specified temperature values. The temperature dependence of the pH values is taken into consideration during calibration.

No.	Buffer set *	pH values	at
1	<i>ConCal</i>	Any	Any
2	<i>NIST/DIN</i> DIN buffers according to DIN 19266 and NIST Traceable Buffers	1.679 4.006 6.865 9.180 12.454	25 °C
3	<i>TEC</i> Technical buffers	2.000 4.010 7.000 10.011	25 °C
4	<i>Merck 1*</i>	4.000 7.000 9.000	20 °C
5	<i>Merck 2 *</i>	1.000 6.000 8.000 13.000	20 °C
6	<i>Merck 3 *</i>	4.660 6.880 9.220	20 °C
7	<i>Merck 4 *</i>	2.000 4.000 7.000 10.000	20 °C
8	<i>Merck 5 *</i>	4.010 7.000 10.000	25 °C

No.	Buffer set *	pH values	at
9	<i>DIN 19267</i>	1.090 4.650 6.790 9.230	25 °C
10	<i>Mettler Toledo USA *</i>	1.679 4.003 7.002 10.013	25 °C
11	<i>Mettler Toledo EU *</i>	1.995 4.005 7.002 9.208	25 °C
12	<i>Fisher *</i>	2.007 4.002 7.004 10.002	25 °C
13	<i>Fluka BS *</i>	4.006 6.984 8.957	25 °C
14	<i>Radiometer *</i>	1.678 4.005 7.000 9.180	25 °C
15	<i>Baker *</i>	4.006 6.991 10.008	25 °C
16	<i>Metrohm *</i>	3.996 7.003 8.999	25 °C
17	<i>Beckman *</i>	4.005 7.005 10.013	25 °C
18	<i>Hamilton Duracal *</i>	4.005 7.002 10.013	25 °C
19	<i>Precisa *</i>	3.996 7.003 8.999	25 °C
20	<i>Reagecon TEC *</i>	2.000 4.010 7.000 10.000	25 °C

No.	Buffer set *	pH values	at
21	<i>Reagecon 20</i> *	2.000 4.000 7.000 10.000 13.000	20 °C
22	<i>Reagecon 25</i> *	2.000 4.000 7.000 10.000 13.000	25 °C
23	<i>Chemsolute</i> *	2.000 4.000 7.000 10.000	20 °C
24	<i>USABlueBook</i> *	4.000 7.000 10.000	25 °C
25	<i>YSI</i> *	4.000 7.,000 10.000	25 °C

\* Brand names or trade names are trademarks of their respective owners protected by law.



The buffers are selected in the menu, pH / **<ENTER>** / *Calibration / Buffer* (see section 7.1.1 SETTINGS FOR PH MEASUREMENTS, page 42).

### 7.1.3 Calibration interval

The calibration evaluation is displayed as a sensor symbol.

After the QSC function has been enabled the sensor symbol is replaced by the QSC scale (see section 5.2.8 QSC FUNCTION (SENSOR QUALITY CONTROL), page 36).

After the specified calibration interval has expired the sensor symbol or the QSC scale flashes. It is still possible to measure.



To ensure the high measuring accuracy of the measuring system, calibrate after the calibration interval has expired.

#### Setting the calibration interval

The calibration interval is set to 7 days in the factory.

You can change the interval (1 ... 999 days):

1. Open the menu for measurement settings with **<ENTER>**.
2. In the *Calibration / Calibration interval* menu, set the calibration interval with **<▲><▼>**.
3. Confirm the setting with **<ENTER>**.
4. Quit the menu with **<M>**.

## 7.2 ORP measurement settings

### 7.2.1 Settings for ORP measurements

The settings are made in the menu for measuring settings of the ORP measurement. To open the settings, display the required measured parameter in the measured value display and press the **<ENTER>** key. After completing the settings, switch to the measured value display with **<M>**.

Default settings are printed in **bold**.

Menu item	Possible setting	Explanation
<i>mV resolution</i>	<b>0.1</b> 1	Resolution of the mV display
<i>Reset</i>	-	Resets all sensor settings to the delivery condition (see section 7.4.1 RESETTING THE MEASUREMENT SETTINGS, page 49).

## 7.3 Sensor-independent settings

### 7.3.1 System

To open the *Storage & config* menu, press the **<ENTER\_>** key in the measured value display. After completing the settings, switch to the measured value display with **<M>**.

Default settings are printed in **bold**.

Menu item	Possible setting	Explanation
<i>System / General / Language</i>	<i>Deutsch</i> <b>English</b> (more)	Selects the menu language
<i>System / General / Audio signal</i>	<b>on</b> off	Switches on/off the beep on keystroke
<i>System / General / Illumination</i>	<b>Auto</b> on off	Switches the display illumination on/off

Menu item	Possible setting	Explanation
<i>System / General / Contrast</i>	0 ... <b>50</b> ... 100 %	Changes the display contrast
<i>System / General / Shutoff time</i>	10 min ... <b>1h</b> ... 24 h	Adjusts the switch-off time
<i>System / General / Temperature unit</i>	°C °F	Temperature unit, degrees Celsius or degrees Fahrenheit. All temperature values are displayed with the selected unit.
<i>System / General / Stability control</i>	<b>on</b> <b>off</b>	Switches on or off the automatic stability control during measurement (see section 7.3.3 AUTOMATIC STABILITY CONTROL, page 48 )
<i>System / Interface / Baud rate</i>	1200, 2400, <b>4800</b> , 9600, 19200	Baud rate of the USB Device interface
<i>System / Interface / Output format</i>	<b>ASCII</b> CSV	Output format for data transmission For details, see section 9 TRANSMITTING DATA (USB INTERFACE), page 57
<i>System / Interface / Decimal separator</i>	<b>Dot (xx.x)</b> Comma (xx,x)	Decimal separator
<i>System / Interface / Output header</i>		Output of a header for <i>Output format: CSV</i>
<i>System / Clock function</i>	<i>Date format</i> <i>Datum</i> <i>Time</i>	Settings of time and date. For details, see section 4.4.5 EXAMPLE 2 ON NAVIGATION: SETTING THE DATE AND TIME, page 21
<i>System / Service information</i>		Hardware version and software version of the meter are displayed.
<i>System / Reset</i>	-	Resets the system settings to the default values. For details, see section 7.4.2 RESETTING THE SYSTEM SETTINGS, page 50

### 7.3.2 Data storage

This menu contains all functions to display, edit and erase stored measured values.



Detailed information on the memory functions of the pH 3310 IDS are given in section 8 DATA MEMORY, page 51.

### 7.3.3 Automatic *Stability control*

The automatic *Stability control* (AutoRead) function continuously checks the stability of the measurement signal. The stability has a considerable impact on the reproducibility of measured values.

You can activate or switch off the automatic *Stability control* function (see section 7.3 SENSOR-INDEPENDENT SETTINGS, page 46).

The measured parameter flashes on the display

- as soon as the measured value is outside the stability range
- when the automatic *Stability control* is switched off.

### 7.3.4 Automatic switch-off function

The instrument has an automatic switch-off function in order to save the batteries (see section 7.3.1 SYSTEM, page 46). The automatic switchoff function switches off the meter if no key is pressed for an adjustable period.

The automatic switchoff function is not active

- if a USB-B cable is connected
- if the *Automatic data storage* function is active, or with *automatic data transmission*

### 7.3.5 Display illumination

The meter automatically switches off the display illumination if no key is pressed for 20 seconds.

The illumination is switched on with the next keystroke again.

You can also generally switch on the display illumination (see section 7.3.1 SYSTEM, page 46).



## 7.4 Reset

You can reset (initialize) all sensor settings and sensor-independent settings separately from each other.

### 7.4.1 Resetting the measurement settings



The calibration data are reset to the default settings together with the measuring parameters. Recalibrate after performing a reset.

**pH** The following settings for pH measurements are reset to the default settings with the *Reset* function:

Setting	Default settings
<i>Buffer</i>	TEC
<i>Calibration interval</i>	7 d
<i>Unit for slope</i>	mV/pH
<i>Measured parameter</i>	pH
<i>Unit for slope</i>	0.001
<i>mV resolution</i>	0.1
<i>Asymmetry</i>	0 mV
<i>Slope</i>	-59.2 mV
<i>Man. temperature</i>	25 °C
<i>Single-point calibration</i>	off

The sensor settings are reset under the *Reset* menu item in the menu for calibration and measurement settings. To open the settings, display the required measured parameter in the measured value display and press the **<ENTER>** key.

**ORP** The following settings for ORP measurements are reset to the default settings with the *Reset* function:

Setting	Default settings
<i>mV resolution</i>	0.1
<i>Man. temperature</i>	25 °C

The sensor settings are reset under the *Reset* menu item in the menu for calibration and measurement settings. To open the settings, display the required measured parameter in the measured value display and press the **<ENTER>** key.

### 7.4.2 Resetting the system settings

The following system settings can be reset to the default condition:

Setting	Default settings
<i>Language</i>	English
<i>Audio signal</i>	on
<i>Baud rate</i>	4800 Baud
<i>Output format</i>	ASCII
<i>Decimal separator</i>	.
<i>Contrast</i>	50 %
<i>Illumination</i>	Auto
<i>Shutoff time</i>	1 h
<i>Temperature unit</i>	°C
<i>Stability control</i>	on

The system settings are reset in the menu, *Storage & config / System / Reset*. To open the *Storage & config* menu, press the **<ENTER\_>** key in the measured value display.

## 8 Data memory

You can store measured values (datasets) to the data memory:

- Manual data storage (see section 8.1 MANUAL STORAGE, page 51)
- Automatic data storage at intervals (see section 8.2 AUTOMATIC DATA STORAGE AT INTERVALS, page 52)

Each data storage process transmits the current dataset to the interface at the same time.

### 8.1 Manual storage

You can store a measurement dataset to the data memory as follows. The dataset is at the same time output to the interface:

1. Press the **<STO>** key shortly.  
The menu for manual data storage appears.

Manual data storage 4 von 500  
01.02.2014 07:43:33  
pH 7.000 24.8 °C AR +++  
  
ID number: 1  
continue  
  
Back 01.02.2014 08:00

2. If necessary, change and confirm the ID number (1 ... 10000) with **<▲><▼>** and **<ENTER>**.  
The dataset is stored. The meter switches to the measured value display.

#### If the memory is full

When all memory locations are occupied, it is not possible to continue storing. Then you can e.g. store the data from the memory to a PC (see section 8.3.1 EDITING THE MEASUREMENT DATA MEMORY, page 54) and subsequently erase the data memory (see section 8.3.2 ERASING THE MEASUREMENT DATA MEMORY, page 55).

## 8.2 Automatic data storage at intervals

The storage interval (*Interval*) determines the time interval between automatic data storage processes. Each data storage process transmits the current data set to the interface at the same time.

### Configuring the automatic storage function

1. Press the **<STO\_>** key.  
The menu for automatic data storage appears.

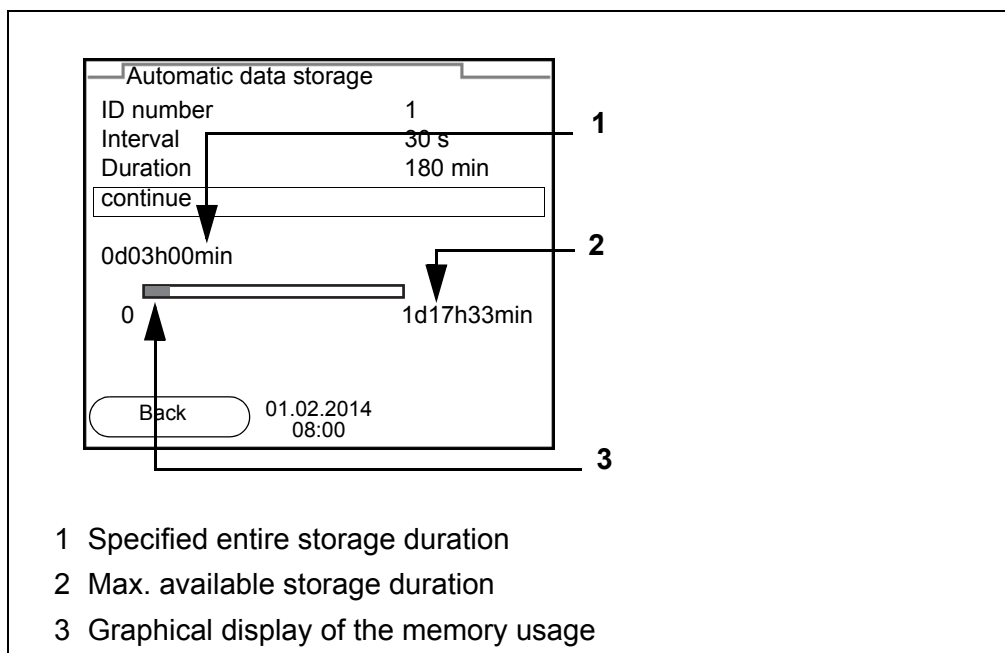

### Settings

You can configure the automatic data storage function with the following settings:

Menu item	Possible setting	Explanation
<i>ID number</i>	1 ... 10000	ID number for the dataset series.
<i>Interval</i>	1 s, 5 s, 10 s, 30 s, 1 min, 5 min, 10 min, 15 min, 30 min, 60 min	Storage interval. The lower limit of the storage interval can be restricted by the number of free memory locations. The upper limit is restricted by the storage duration.
<i>Duration</i>	1 min ... x min	Storage duration. Specifies after which time the automatic data storage should be terminated. The lower limit of the storage duration is restricted by the storage interval. The upper limit is restricted by the number of free memory locations.

### Starting the automatic storage function

To start the automatic storage function, select *continue* with  $\blacktriangle$  $\blacktriangledown$  and confirm with  $\langle$ ENTER $\rangle$ . The meter switches to the measured value display.

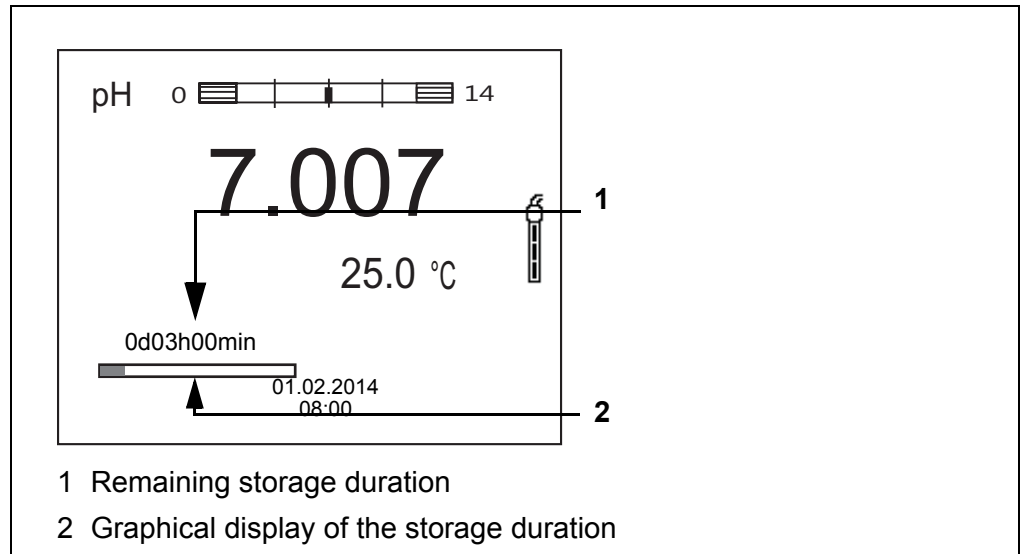

The active automatic data storage function can be recognized by the progress bar in the status line. The progress bar indicates the remaining storage duration.



If the automatic data storage function is activated *only the following keys are active*:  $\langle$ M $\rangle$ ,  $\langle$ STO\_ $\rangle$  and  $\langle$ On/Off $\rangle$ . The other keys and the automatic switch-off function are deactivated.

### Terminating the automatic storage function prematurely

Proceed as follows to switch off the automatic data storage function before the adjusted storage duration has expired:

1. Press the  $\langle$ STO\_ $\rangle$  key.  
The following window appears.

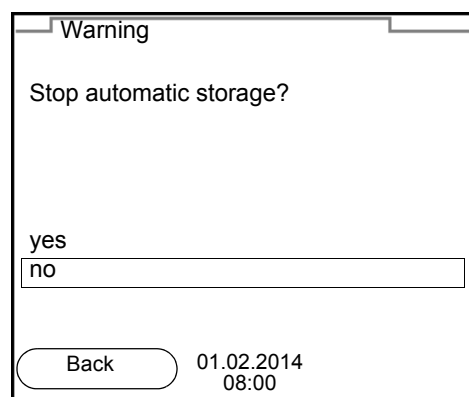

2. Using  $\blacktriangle$  $\blacktriangledown$ , select *yes* and confirm with  $\langle$ ENTER $\rangle$ .  
The meter switches to the measured value display.  
The automatic data storage function is terminated.

### 8.3 Measurement data memory

#### 8.3.1 Editing the measurement data memory

The contents of the manual or automatic measurement data memory can be shown on the display.

Each of the measurement data memories has a function to erase the entire contents.

#### Editing the data memory

The memory is edited in the menu, *Storage & config/ Data storage*. To open the *Storage & config* menu, press the **<ENTER\_>** key in the measured value display.

Open the manual or automatic memory directly with the **<RCL>** or **<RCL\_>** key.



The settings are explained here using the manual data memory as an example. The same settings and functions are available for the automatic data memory.

#### Settings

Menu item	Setting/function	Explanation
<i>Data storage / Manual data storage / Display</i>	-	Displays all measurement datasets page by page.  Further options: <ul style="list-style-type: none"> <li>● Scroll through the datasets with <b>&lt;▲&gt;&lt;▼&gt;</b>.</li> <li>● Output the displayed dataset to the interface with <b>&lt;F2&gt;/[USB output]</b>.</li> <li>● Quit the display with <b>&lt;F1&gt;/[Back]</b>.</li> </ul>
<i>Data storage / Manual data storage / Output to RS232/ USB</i>	-	Outputs all stored measurement data to the interface.
<i>Data storage / Manual data storage / Erase</i>	-	Erases the entire manual measurement data memory. Note: All calibration data remain stored when this action is performed.

**Display presentation  
of a dataset**

Manual data storage	3 of 64	◆
01.02.2014 07:43:33 ID number: 1		
SenTix 940 B092500013		
pH 7.000 24.8 °C AR Sensor: +++		
Back	01.02.2014 08:00	USB output

**Representation of a  
dataset  
(USB output)**

```

01.02.2014 07:43:33
pH 3310 IDS
Ser. no. 11350001

ID number 2

SenTix 940
Ser. no. B092500013
pH 6.012 24.8 °C, AR, S: +++

-----

01.02.2014 07:43:53
pH 3310 IDS
Ser. no. 11350001

ID number 2
SenTix 940
Ser. no. B092500013
pH 6.012 24.8 °C, AR, S: +++

-----

etc...

```

**Quitting the display**

To quit the display of stored measurement datasets, you have the following options:

- Switch directly to the measured value display with **<M>**.
- Quit the display and move to the next higher menu level with **<F1>/[Back]**.

**8.3.2 Erasing the measurement data memory**

Erasing the measurement data memory (see section 8.3.1 EDITING THE MEASUREMENT DATA MEMORY, page 54).

### 8.3.3 Measurement dataset

A complete dataset consists of:

- Date/time
- Meter name, series number
- Sensor name, series number
- ID number
- Measured value of the connected sensor
- Measured temperature value of the connected sensor
- AutoRead info: *AR* appears with the measured value if the AutoRead criterion was met while storing (stable measured value). Otherwise, the *AR* display is missing.
- Calibration evaluation:
  - 4 levels (+++, ++, +, -, or no evaluation)

### 8.3.4 Storage locations

The pH 3310 IDS meter has two measurement data memories. The measured values recorded either manually or automatic are stored separately in individual measurement data memories.

Memory	Maximum number of datasets
<i>Manual data storage</i>	500
<i>Automatic data storage</i>	4500



## 9 Transmitting data (USB interface)

### 9.1 Outputting current measurement data

1. Output the current measurement data to the USB-B interface with <F2>[USB output].

### 9.2 Transmitting data (to a PC)

The meter has a USB-B interface (*USB Device*) e.g. to connect a PC.

Via the USB-B interface (*USB Device*) you can store data to a PC or printer and update the meter software.

### 9.3 Connecting the PC / USB-B interface (*USB Device*)

Connect the pH 3310 IDS to the PC via the USB-B interface.

#### Installation of the USB driver on the PC

System requirements of the PC for installation of the USB driver:

- PC with at least one free USB connection and CD-ROM drive
- Windows 2000, Windows XP, Windows Vista or Windows 7.

1. Insert the supplied installation CD in the CD drive of your PC.
2. Install the driver from the CD.  
Follow the Windows installation instructions as necessary.
3. Connect the pH 3310 IDS to the PC via the USB-B interface.  
The meter is listed as a virtual COM interface among the connections in the Windows instrument manager.
4. Set the same transmission data at the connected instrument (PC):
  - Baud rate: to be selected in the range 1200 ... 19200
  - Handshake: RTS/CTS
  - Set at the PC only:
    - Parity: none
    - Data bits: 8
    - Stop bits: 2

## 9.4 Options for data storage to a PC

Via the USB-B interface you can store data to a PC. The following table shows which data are transmitted to the interface in which way:

Data	Control	Operation / description
Current measured values of all connected sensors	Manual	<ul style="list-style-type: none"> <li>● With <b>&lt;F2&gt;</b>/[USB output].</li> <li>● Simultaneously with every manual data storage process (see section 8.1 MANUAL STORAGE, page 51).</li> </ul>
	Automatic, at intervals	<ul style="list-style-type: none"> <li>● With <b>&lt;F2__&gt;</b>/[USB output]. Then you can set the transmission interval.</li> <li>● Simultaneously with every automatic data storage process (see section 8.2 AUTOMATIC DATA STORAGE AT INTERVALS, page 52).</li> </ul>
Stored measured values	Manual	<ul style="list-style-type: none"> <li>● Displayed dataset with <b>&lt;F2&gt;</b>/[USB output] after calling up from the memory.</li> <li>● All datasets with the <i>Output to RS232/USB</i> function. (see section 8.3.1 EDITING THE MEASUREMENT DATA MEMORY, page 54).</li> </ul>
Calibration records	Manual	<ul style="list-style-type: none"> <li>● Calibration record with <b>&lt;F2&gt;</b>/[USB output] (see section 5.2.6 CALIBRATION DATA, page 32).</li> </ul>
	Automatic	<ul style="list-style-type: none"> <li>● At the end of a calibration procedure.</li> </ul>



The following rule applies: With the exception of the menus, shortly pressing the **<F2>**/[USB output] key generally outputs the display contents to the interface (displayed measured values, measuring datasets, calibration records).

## 9.5 MultiLab Importer

With the aid of the MultiLab Importer software, you can record and evaluate measurement data with a PC.



More detailed information can be found in the MultiLab Importer operating manual.

## 10 Maintenance, cleaning, disposal

### 10.1 Maintenance

#### 10.1.1 General maintenance activities

The only maintenance activity required is replacing the batteries.



See the relevant operating manuals of the IDS sensors for instructions on maintenance.

#### 10.1.2 Replacing the batteries

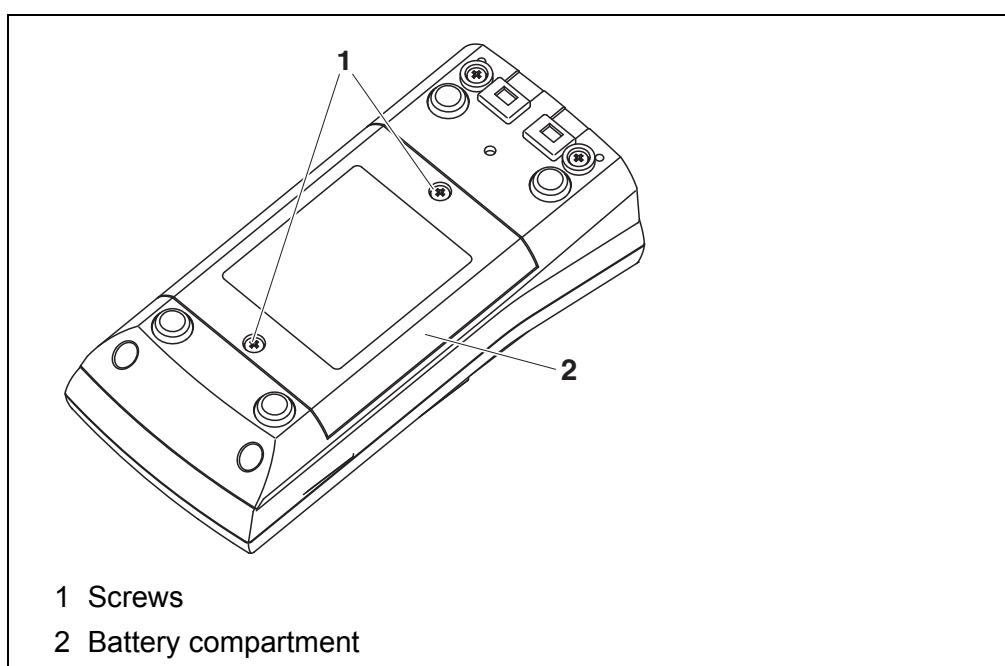

1. Unscrew the two screws (1) on the underside of the meter.
2. Open the battery compartment (1) on the underside of the meter.
3. Remove the batteries from the battery compartment.



#### CAUTION

Make sure that the poles of the batteries are positioned correctly.

The  $\pm$  signs on the batteries must correspond to the  $\pm$  signs in the battery compartment.



You can operate the meter either with normal batteries or with rechargeable batteries (Ni-MH). In order to charge the batteries, an external charging device is required.

4. Place four batteries (type Mignon AA) in the battery compartment.
5. Close the battery compartment (2) and tighten the screws (1).
6. Set the date and time  
(see section 4.4.5 EXAMPLE 2 ON NAVIGATION: SETTING THE DATE AND TIME, page 21).



Dispose of used batteries according to the local regulations of your country.

End users within the European Union are obligated to return used batteries (even ecologically compatible ones) to a collection point set up for recycling purposes.

Batteries are marked with the crossed-out waste container symbol. Therefore, they may not be disposed with the domestic waste.

## 10.2 Cleaning

Occasionally wipe the outside of the measuring instrument with a damp, lint-free cloth. Disinfect the housing with isopropanol as required.



### **CAUTION**

**The housing is made of synthetic material (ABS). Thus, avoid contact with acetone or similar detergents that contain solvents. Remove any splashes immediately.**

## 10.3 Packing

This meter is sent out in a protective transport packing. We recommend: Keep the packing material. The original packing protects the meter against damage during transport.

## 10.4 Disposal

At the end of its operational lifetime, the meter must be returned to the disposal or return system statutory in your country. If you have any questions, please contact your supplier.

## 11 What to do if...

### 11.1 pH



More information and instructions on cleaning and exchange of sensors are given in the documentation of your sensor.

**Error message**  
**OFL, UFL**

The measured value is outside the measuring range.

Cause	Remedy
IDS pH sensor:	
– The measured value is outside the measuring range of the meter	– Use suitable IDS pH sensor
– Air bubble in front of the junction	– Remove air bubble (e.g. sway or stir the solution)
– Air in the junction	– Extract air or moisten junction
– Gel electrolyte dried out	– Replace the sensor

**Error message,**  
**Error**

Cause	Remedy
IDS pH sensor:	
– The values determined for zero point and slope of the IDS pH sensor are outside the allowed limits.	– Recalibrate
– Junction contaminated	– Clean the junction
– Sensor broken	– Replace the sensor
Buffer solutions:	
– The used buffer solutions do not agree with the set buffer set	– Set different buffer set or – Use different buffer solutions
– Buffer solutions too old	– Use only once. Note the shelf life
– Buffer solutions depleted	– Change solutions

No stable measured value	Cause	Remedy
	IDS pH sensor:	
	– Junction contaminated	– Clean junction
	– Membrane contaminated	– Clean membrane
	– Junction contaminated	– Clean the junction
	– Membrane contaminated	– Clean membrane
	Test sample:	
	– pH value not stable	– Measure with air excluded if necessary
	– Temperature not stable	– Adjust temperature if necessary
	IDS pH sensor + test sample:	
	– Conductivity too low	– Use suitable IDS pH sensor
	– Temperature too high	– Use suitable IDS pH sensor
	– Organic liquids	– Use suitable IDS pH sensor

### Obviously incorrect measured values

Cause	Remedy
IDS pH sensor:	
– Sensor unsuitable	– Use suitable IDS sensor
– Temperature difference between buffer and test sample too great	– Adjust temperature of buffer or sample solutions
– Measurement procedure not suitable	– Follow special procedure

## 11.2 General information

### Sensor symbol flashes

Cause	Remedy
– Calibration interval expired	– Recalibrate the measuring system

### Display



Cause	Remedy
– Batteries almost empty	– Replace the batteries (see section 10.1 MAINTENANCE, page 59)

<b>Meter does not react to keystroke</b>	<b>Cause</b>	<b>Remedy</b>
	<ul style="list-style-type: none"> <li>– Operating condition undefined or EMC load unallowed</li> </ul>	<ul style="list-style-type: none"> <li>– Processor reset: Press the <b>&lt;ENTER&gt;</b> and <b>&lt;On/Off&gt;</b> key simultaneously</li> </ul>
<b>You want to know which software version is in the meter or IDS sensor</b>	<b>Cause</b>	<b>Remedy</b>
	<ul style="list-style-type: none"> <li>– E.g., a question by the service department</li> </ul>	<ul style="list-style-type: none"> <li>– Switch on the meter.</li> <li>– Open the menu, <b>&lt;ENTER_&gt;</b> / <i>Storage &amp; config / System / Service information</i>. The instrument data are displayed.</li> </ul> <p style="text-align: center;">or</p> <ul style="list-style-type: none"> <li>– Connect the sensor. Press softkey [<b>&lt;F1&gt;Info&lt;F1&gt;</b>] / <i>[More]</i> The sensor data are displayed (see section 4.1.5 SENSOR INFO, page 16)</li> </ul>

## 12 Technical data

### 12.1 Measuring ranges, resolution, accuracy



The data are given in the documentation of your sensor.

### 12.2 General data

<b>Dimensions</b>	pH 3310 IDS:	Approx. 180 x 80 x 55 mm
<b>Weight</b>	pH 3310 IDS:	Approx. 0.4 kg
<b>Mechanical structure</b>	Type of protection	IP 67
<b>Electrical safety</b>	Protective class	III
<b>Test certificates</b>	CE	
<b>Ambient conditions</b>	Storage	- 25 °C ... + 65 °C
	Operation	+5 °C ... + 55 °C
	Admissible relative humidity	Yearly mean: < 75 % 30 days/year: 95 % Other days: 85 %
<b>Power supply</b>	Batteries	4 x 1.5 V alkali-manganese batteries, type AA
	Operational life	Approx. 200 h*

\* The operational life is shorter is the display illumination is switched on permanently

<b>USB interface (device)</b>	Type	USB 1.1 USB-B (Device), PC
	Baud rate	Adjustable: 1200, 2400, 4800, 9600, 19200 Baud
	Data bits	8
	Stop bits	2
	Parity	None
	Handshake	RTS/CTS
	Cable length	Max. 3 m

<b>Guidelines and norms used</b>	EMC	EC directive 2004/108/EC EN 61326-1 EN 61000-3-2 EN 61000-3-3 FCC Class A
----------------------------------	-----	---



---

Meter safety	EC directive 2006/95/EC EN 61010-1 UL 61010-1 CAN/CSA-C22.2#61010-1
IP protection class	EN 60529

---

## 13 Firmware update

### 13.1 Firmware update for the meter pH 3310 IDS

You can find available firmware update files for your meter on the Internet. With the "Firmware Update " program and a PC you can update the firmware of the pH 3310 IDS to the newest version.

For the update you have to connect the meter to a PC.

For the update via the USB-B interface, the following is required:

- a free USB interface (virtual COM port) on the PC
- the driver for the USB interface (on the enclosed CD-ROM)
- the USB cable (included in the scope of delivery of the pH 3310 IDS).

1. Install the downloaded firmware update on a PC.  
An update folder is created in the Windows start menu.  
If an update folder already exists for the meter (or meter type), the new data are displayed there.
2. In the windows start menu, open the update folder and start the firmware update program for the meter
3. Using the USB interface cable, connect the pH 3310 IDS to a USB interface (virtual COM port) of the PC.
4. Switch on the pH 3310 IDS.
5. In the firmware update program, start the update process with OK.
6. Follow the instructions of the firmware update program.  
During the programming process, a corresponding message and a progress bar (in %) are displayed.  
The programming process takes up to 5 minutes. A terminatory message is displayed after a successful programming process. The firmware update is completed.
7. Disconnect the pH 3310 IDS from the PC.  
The pH 3310 IDS is ready for operation again.

After switching the meter off and on you can check whether the meter has taken over the new software version (see YOU WANT TO KNOW WHICH SOFTWARE VERSION IS IN THE METER OR IDS SENSOR, PAGE 63).

## 13.2 Firmware-Update for IDS Sensors

With the "Firmware Update" program and a PC you can update the firmware of an IDS sensor to the newest version.

You can find available firmware update files for your IDS sensor on the Internet.

For updating, connect the IDS sensor to the pH 3310 IDS, and the pH 3310 IDS to a PC.

For the update via the USB-B interface, the following is required:

- a free USB interface (virtual COM port) on the PC
- the driver for the USB interface (on the enclosed CD-ROM)
- the USB cable (included in the scope of delivery of the pH 3310 IDS).

1. Install the downloaded firmware update on a PC.  
An update folder is created in the Windows start menu.  
If an update folder already exists for the sensor (or sensor type), the new data are displayed there.
2. In the windows start menu, open the update folder and start the firmware update program for the IDS sensor
3. Connect the IDS sensor to the pH 3310 IDS meter.
4. Using the USB interface cable, connect the pH 3310 IDS to a USB interface (virtual COM port) of the PC.
5. Switch on the pH 3310 IDS.
6. In the firmware update program, start the update process with OK.
7. Follow the instructions of the firmware update program.  
During the programming process, a corresponding message and a progress bar (in %) are displayed.  
The programming process takes up to 5 minutes. A terminatory message is displayed after a successful programming process. The firmware update is completed.
8. Disconnect the pH 3310 IDS from the PC.  
Meter and sensor are ready for operation again.

After switching the meter off and on you can check whether the sensor has taken over the new software version (see YOU WANT TO KNOW WHICH SOFTWARE VERSION IS IN THE METER OR IDS SENSOR, PAGE 63).

## 14 Glossary

### pH/ORP

<b>Asymmetry</b>	see zero point
<b>Junction</b>	The junction is a porous body in the housing wall of reference electrodes or electrolyte bridges. It arranges the electrical contact between two solutions and makes the electrolyte exchange more difficult. The expression, junction, is also used for ground or junction-less transitions.
<b>Electromotive force of an electrode</b>	The electromotive force $U$ of the electrode is the measurable electromotive force of an electrode in a solution. It equals the sum of all the galvanic voltages of the electrode. Its dependency on the pH results in the electrode function, which is characterized by the parameters, slope and zero point.
<b>Zero point</b>	The zero point of a pH electrode is the pH value at which the electromotive force of the pH electrode at a specified temperature is zero. Normally, this is at 25 °C.
<b>pH value</b>	The pH value is a measure of the acidic or basic effect of an aqueous solution. It corresponds to the negative decadic logarithm of the molal hydrogen ions activity divided by the unit of the molality. The practical pH value is the value of a pH measurement.
<b>Potentiometry</b>	Name of a measuring technique. The signal (depending on the measured parameter) of the electrode is the electrical potential. The electrical current remains constant.
<b>ORP (U)</b>	The ORP is caused by oxidizing or reducing substances dissolved in water if these substances become effective on an electrode surface (e.g. a gold or platinum surface).
<b>Slope</b>	The slope of a linear calibration function.

### General information

<b>Resolution</b>	Smallest difference between two measured values that can be displayed by a meter.
<b>AutoRange</b>	Name of the automatic selection of the measuring range.
<b>Adjusting</b>	To manipulate a measuring system so that the relevant value (e.g. the displayed value) differs as little as possible from the correct value or a value that is regarded as correct, or that the difference remains within the tolerance.
<b>Calibration</b>	Comparing the value from a measuring system (e.g. the displayed value) to the correct value or a value that is regarded as correct. Often, this expression is also used when the measuring system is adjusted at the same time (see adjusting).
<b>Measured parameter</b>	The measured parameter is the physical dimension determined by measuring, e.g. pH, conductivity or D.O. concentration.

---

<b>Test sample</b>	Designation of the test sample ready to be measured. Normally, a test sample is made by processing the original sample. The test sample and original sample are identical if the test sample was not processed.
<b>Measured value</b>	The measured value is the special value of a measured parameter to be determined. It is given as a combination of the numerical value and unit (e.g. 3 m; 0.5 s; 5.2 A; 373.15 K).
<b>Molality</b>	Molality is the quantity (in Mol) of a dissolved substance in 1000 g solvent.
<b>Reset</b>	Restoring the original condition of all settings of a measuring system.
<b>Stability control (AutoRead)</b>	Function to control the measured value stability.
<b>Standard solution</b>	The standard solution is a solution where the measured value is known by definition. It is used to calibrate a measuring system.
<b>Temperature function</b>	Name of a mathematical function expressing the temperature behavior of a test sample, a sensor or part of a sensor.



## 15 Index

### A

Automatic switch-off function	48
AutoRead	
ORP	39
pH	23

### B

Battery compartment	13, 59
---------------------	--------

### C

Calibration	
pH	25, 41
Calibration evaluation	
pH	33
Calibration interval	
pH	45
Calibration points	
pH	31
Connecting a PC	57
Connectors	16
Copyright	2

### D

Dataset	56
Date and time	21
Default settings	
Measured parameter	49
System settings	50
Display	15

### F

Firmware update	66
-----------------	----

### I

Initial commissioning	12
Initialize	49
Interval for calibration	45

### K

Keys	14
------	----

### M

Measured value display	18
Measurement accuracy	45
Measurement data memory	
Edit	54
Erase	54
Storage locations	56

Measurement dataset	56
Measuring	
ORP	39
pH	23
Menu for calibration and measurement settings	
pH/ORP	42
Menus (navigation)	18
Messages	19

### P

pH buffer sets	43
----------------	----

### R

Reset	49
-------	----

### S

Scope of delivery	12
Single-point calibration	
pH	26, 30
Slope	
pH	25
Stability control	
Automatic	48
Manual	23, 39
Storage interval	52
Storing in memory	51
Automatic	52
Manual	51

### T

Temperature measurement	
pH	24, 40
Three-point calibration	
pH	27, 31
Transmitting data	57
Automatic	58
Manual	58
Transmitting measured values	57
Two-point calibration	
pH	27, 30

### Z

Zero point of pH electrode	25
----------------------------	----







# Xylem |'zīləm|

- 1) The tissue in plants that brings water upward from the roots;
- 2) a leading global water technology company.

We're 12,500 people unified in a common purpose: creating innovative solutions to meet our world's water needs. Developing new technologies that will improve the way water is used, conserved, and re-used in the future is central to our work. We move, treat, analyze, and return water to the environment, and we help people use water efficiently, in their homes, buildings, factories and farms. In more than 150 countries, we have strong, long-standing relationships with customers who know us for our powerful combination of leading product brands and applications expertise, backed by a legacy of innovation.

**For more information on how Xylem can help you, go to [www.xylem.com](http://www.xylem.com)**



## **Wissenschaftlich-Technische Werkstätten GmbH**

Dr.-Karl-Slevogt-Straße 1  
D-82362 Weilheim  
Germany

Tel: +49 881 183-0  
Fax: +49 881 183-420  
E-Mail: [info@wtw.com](mailto:info@wtw.com)  
Internet: [www.wtw.com](http://www.wtw.com)