

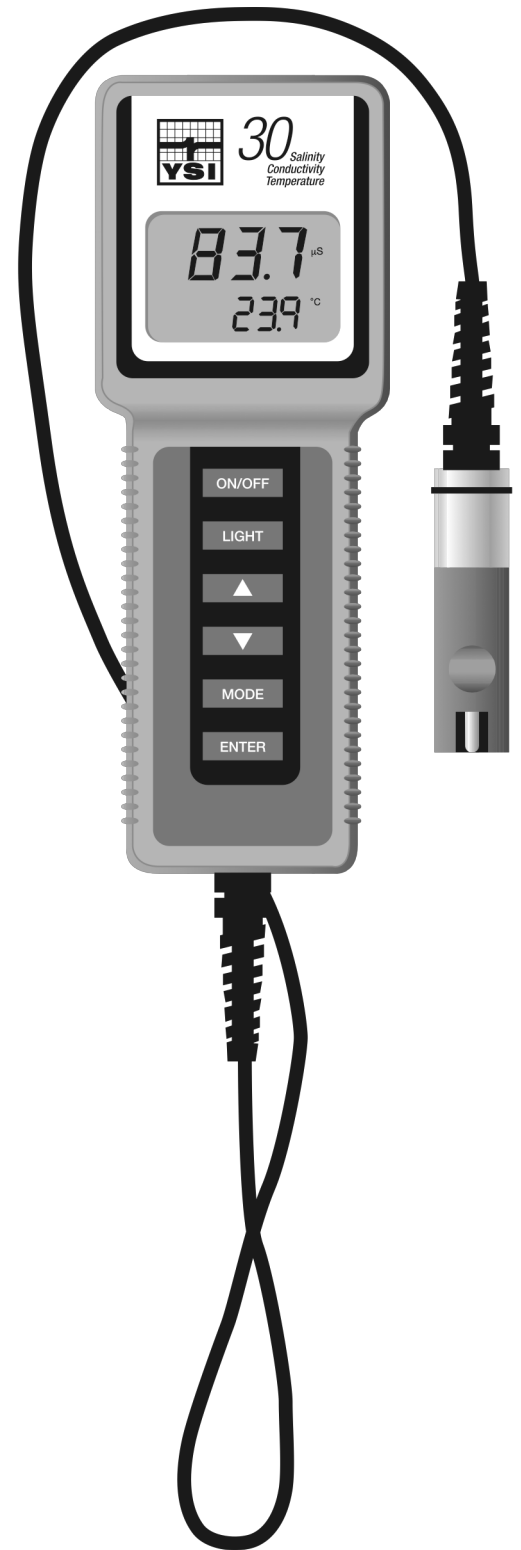

*YSI incorporated*



**YSI Model 30  
YSI Model 30M  
Handheld Salinity,  
Conductivity and  
Temperature  
System**

**Operations  
Manual**



# CONTENTS

---

<b>Section 1 Introduction</b> .....	<b>1</b>
<b>Section 2 Preparing The Meter</b> .....	<b>3</b>
2.1 Unpacking .....	3
2.2 Warranty Card .....	3
2.3 Batteries .....	3
2.4 Storage Chamber .....	4
2.5 Hand Strap .....	4
2.6 The Meter Case .....	5
<b>Section 3 Making Measurements</b> .....	<b>6</b>
3.1 Turning The Instrument On .....	6
3.2 Measurement Modes .....	7
3.3 Autoranging & Range Searching .....	8
3.4 The Backlight .....	9
<b>Section 4 Saving Data</b> .....	<b>10</b>
4.1 Saving Data To Memory .....	10
4.2 Recalling Stored Data .....	11
4.3 Erasing Stored Data .....	11
<b>Section 5 Calibration</b> .....	<b>14</b>
5.1 Before You Calibrate .....	14
5.2 The Calibration Process .....	14
<b>Section 6 Advanced Setup</b> .....	<b>15</b>
6.1 Changing The Temperature Coefficient .....	16
6.2 Changing The Reference Temperature .....	17
6.3 Changing From Autoranging To Manual Ranging .....	18
<b>Section 7 Principles of Operation</b> .....	<b>22</b>
7.1 Temperature Effect .....	22
7.2 Discussion Of Measurement Errors .....	23
<b>Section 8 Maintenance</b> .....	<b>24</b>
8.1 Cleaning And Storage .....	26
8.2 Probe Precautions .....	26
<b>Section 9 Troubleshooting</b> .....	<b>28</b>
<b>Section 10 Warranty And Repair</b> .....	<b>31</b>
<b>Appendix A Required Notice</b> .....	<b>37</b>
<b>Appendix B Accessories And Replacement Parts</b> .....	<b>37</b>
<b>Appendix C Temperature Correction Data</b> .....	<b>41</b>
<b>Appendix D Conversion Chart</b> .....	<b>46</b>
<b>Appendix E Glossary</b> .....	<b>48</b>
<b>Appendix F General Specifications</b> .....	<b>47</b>



# SECTION 1 INTRODUCTION

---

The YSI Model 30 Handheld Salinity, Conductivity, & Temperature System is a rugged, micro-processor based, digital meter with an attached YSI four electrode conductivity cell. The Model 30 is designed for use in field, lab, and process control applications and is available with cable lengths of either 10, 25 or 50 feet. The body of the probe has been manufactured with stainless steel to add rugged durability and sinking weight. The large Liquid Crystal Display (LCD) is easy to read and is equipped with a back-light for use in dark or poorly lighted areas.

The Model 30's micro-processor allows the system to be easily calibrated with the press of a few keys. Additionally, the micro-processor performs a self-diagnostic routine each time the instrument is turned on. The self-diagnostic routine provides you with useful information about the cell constant, function of the instrument circuitry, and the quality of the readings you obtain. For a list of these diagnostic features, see Section 9, *Troubleshooting*.

The system simultaneously displays temperature (in °C), along with one of the following parameters: conductivity; temperature compensated conductivity; (in  $\mu\text{S}/\text{cm}$  or  $\text{mS}/\text{cm}$ ), and salinity (in parts per thousand [ppt]). Though calibration is **NOT** required, a single calibration will adjust the instrument, regardless of which parameter you wish to read. You can switch back and forth from salinity, conductivity, and temperature compensated conductivity with a single push of the **MODE** key.

A probe storage chamber is built into the instrument. This chamber provides a convenient place to store the probe when the system is not in use, and provides protection for the electrodes within the probe.

The instrument is powered by six AA-size alkaline batteries. A new set of alkaline batteries will provide approximately 100 hours of continuous operation. When batteries need to be replaced, the LCD will display a "**LO BAT**" message.

The YSI Model 30 instrument case is waterproof (rated to IP65). You can operate your Model 30 in a steady rain without damage to the instrument.

The YSI Model 30M contains all the features of the Model 30, but also has internal memory for saving 50 sets of data for later on screen recall and meets CE requirements for EMC Directive 89/336/EEC. For simplicity, this manual will refer to the Model 30 when discussing functions that apply to both the Model 30 AND the Model 30M. References to the Model 30M indicate functions that apply to the Model 30M ONLY.



## SECTION 2 PREPARING THE METER

---

### 2.1 UNPACKING

---

When you unpack your new YSI Model 30 Handheld Conductivity, Salinity & Temperature System for the first time, check the packing list to make sure you have received everything you should have. If there is anything missing or damaged, call the dealer from whom you purchased the Model 30. If you do not know which of our authorized dealers sold the system to you, call YSI Customer Service at 800-765-4974 or 937-767-7241, and we'll be happy to help you.

### 2.2 WARRANTY CARD

---

Before you do anything else, please complete the Warranty Card and return it to YSI. This will record your purchase of this quality instrument in our computer system. Once your purchase is recorded, you will receive prompt, efficient service in the event any part of your YSI Model 30 should ever need repair.

### 2.3 BATTERIES

---

There are a few things you must do to prepare your YSI Model 30 for use. First, locate the six AA-size alkaline batteries that were included. Use a screwdriver or a small coin to remove the thumbscrew on the bottom of the instrument. This thumbscrew holds the battery-chamber cover in place. The battery-chamber cover is marked with the words "OPEN" and "CLOSE."

NOTE: On some models, the battery cover thumbscrew may be unscrewed by hand (a screwdriver may not be required).

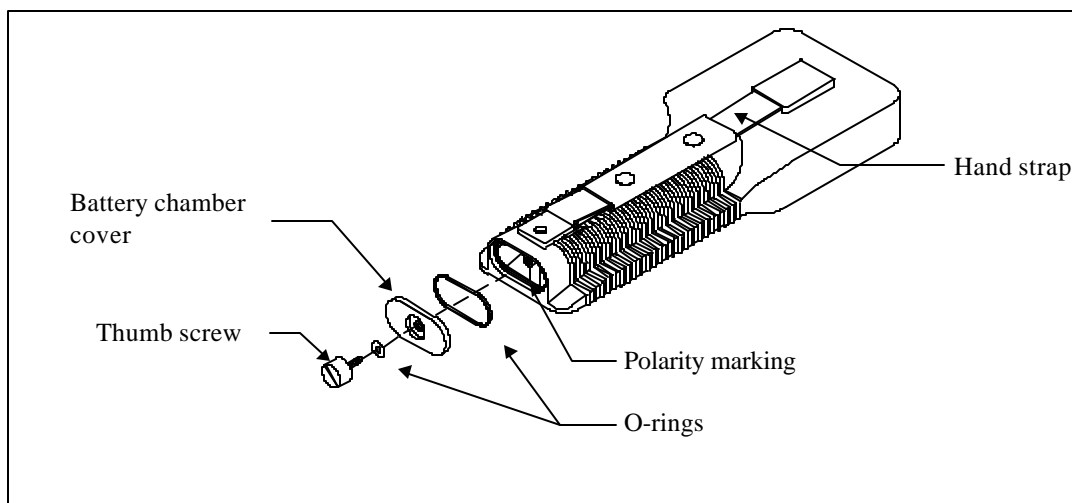

There is a small label inside each of the two battery-chamber sleeves. These labels illustrate the correct way to install the batteries into each sleeve of the battery-chamber.

**NOTE:** It is very important that the batteries be installed **ONLY** as illustrated. The instrument will not function if the batteries are installed incorrectly.

Turn the instrument on by pressing and releasing the **ON/OFF** key on the front of the instrument. The liquid crystal display (LCD) should come on. Allow a few seconds for the instrument to complete its diagnostic routine. Notice that the instrument will display the specific cell constant of the probe at the completion of its diagnostic routine. If the instrument does not operate, consult Section 9, *Troubleshooting*.

You may also want to take the instrument into a dark room and, with the instrument ON, hold down the **LIGHT** key. The instrument back-light should illuminate the LCD so that the display can be easily read.

## 2.4 STORAGE CHAMBER

---

The Model 30 has a convenient storage chamber built into the instrument's side. This chamber provides an ideal storage area for the probe during transport and extended non-use.

An optional sponge is available from YSI that will fit inside the storage chamber and provide a moist environment for probe storage should your application or operational procedures require it. See Appendix B, *Accessories and Replacement Parts*.

## 2.5 HAND STRAP

---

The hand strap is designed to allow comfortable operation of the Model 30 with minimum effort. If the hand strap is adjusted correctly, it is unlikely that the instrument will be easily dropped or bumped from your hand.

To adjust the hand strap on the back of the meter, unsnap the leather cover and pull the two Velcro strips apart. Place your hand between the meter and the strap and adjust the strap length so that your hand is snugly held in place. Press the two Velcro strips back together and snap the leather cover back into place.

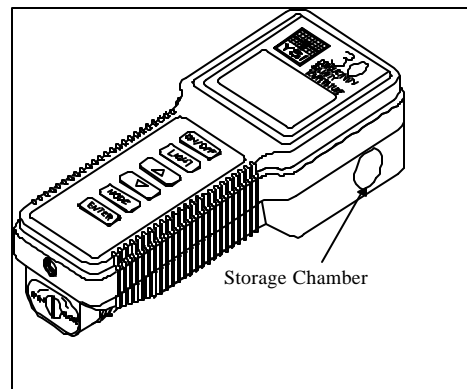

## **2.6 THE METER CASE**

---

The meter case is sealed at the factory and is not intended to be opened, except by authorized service technicians. Do not attempt to separate the two halves of the meter case as this may damage the instrument, break the water-proof seal and may void the manufacturer's warranty.

## SECTION 3 MAKING MEASUREMENTS

The YSI Model 30 is factory calibrated. This means that once you have put batteries in the instrument, you are ready to begin taking readings immediately.

The following diagram is an overview of the operation of the Model 30 and 30M. Note the difference in key strokes between some of the 30 and 30M functions. See the following pages for details of operation.

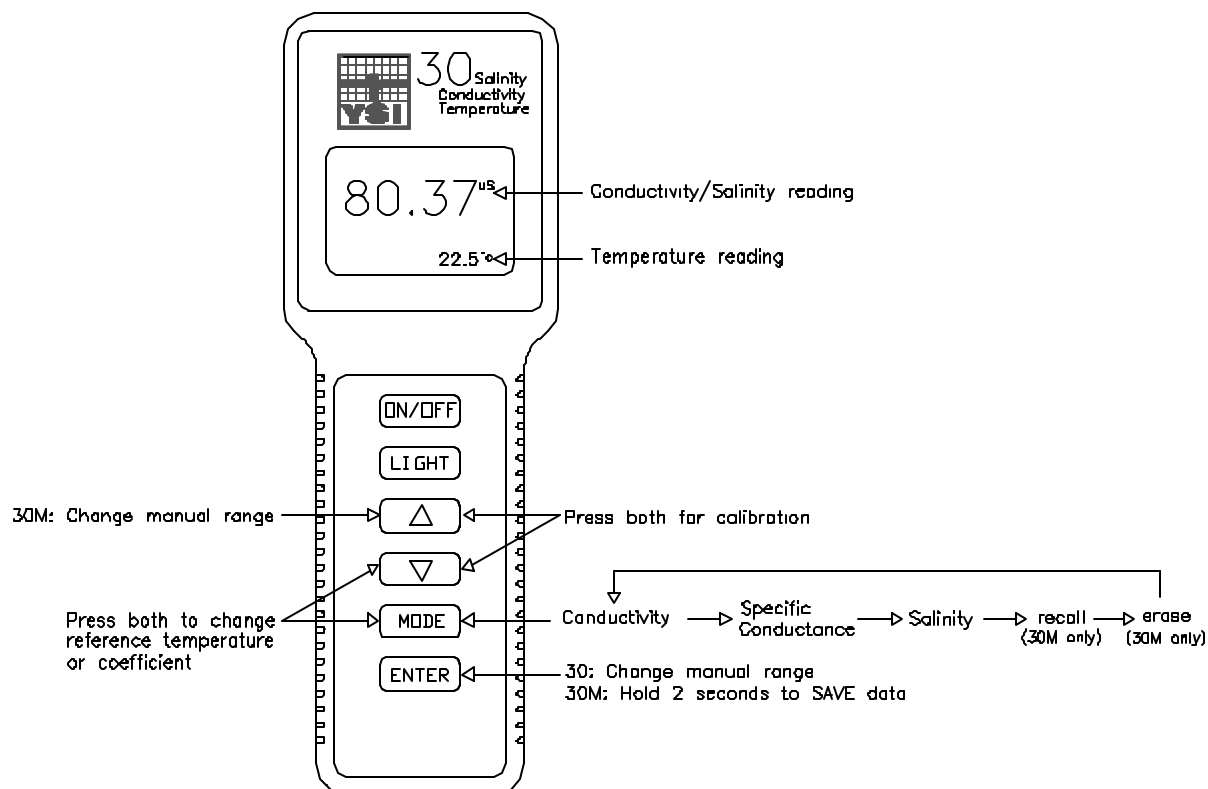

### 3.1 TURNING THE INSTRUMENT ON

Once the batteries are installed correctly, press the **ON/OFF** key. The instrument will activate all segments of the display for a few seconds, which will be followed by a self test procedure which will last for several more seconds. During this power on self test sequence, the instrument's microprocessor is verifying that the instrument is working properly and will display the cell constant of the probe when the self test is complete. If the instrument were to detect a problem, a **continuous** error message would be displayed. See Section 9, *Troubleshooting* for a list of error messages.

After the self test procedure is complete, the temperature will be displayed in the lower right of the display and the instrument is ready to make a measurement. Simply insert the probe into the liquid sample about which you would like to receive information. It is important that the probe be inserted into the liquid deep enough so that the hole on the side of the probe is completely covered by the liquid. If possible, do not allow the probe to touch any solid object while you are taking readings; this may effect

the reading slightly. Additionally, it is important that there not be any air bubbles around the probe electrodes. To dislodge any bubbles which might have formed, move or shake the probe vigorously several times before recording the measurement.

## 3.2 MEASUREMENT MODES

---

The Model 30 has three modes as follows:

- **Conductivity** -- A measurement of the conductive material in the liquid sample without regard to temperature
- **Specific Conductance** -- Also known as temperature compensated conductivity which automatically adjusts the reading to a calculated value which would have been read if the sample had been at 25° C (or some other reference temperature which you choose). See Section 6, *Advanced Setup*.
- **Salinity** -- A calculation done by the instrument electronics, based upon the conductivity and temperature readings.

**Temperature** is displayed in conductivity, specific conductance and salinity modes.

The Model 30M has two additional modes:

- **Recall** -- Allows previously stored data to be displayed.
- **Erase all** -- Allows ALL previously stored data to be deleted.

To change between modes, simply press and release the **MODE** key. The instrument will cycle through the modes as follows:

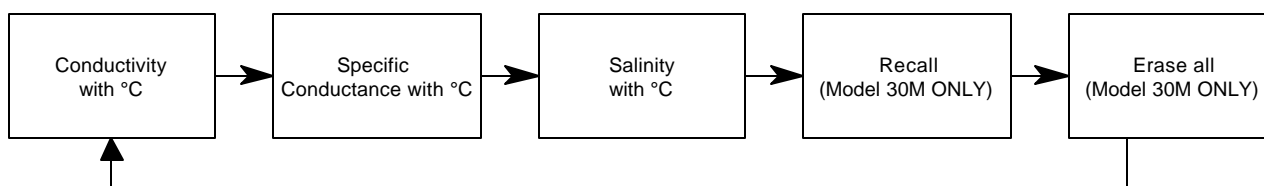

**NOTE:** When you turn the instrument off, it will “remember” which measurement mode you used last and will return to that mode the next time it is turned on.

When changing modes, carefully observe the small legends at the far right side of the LCD. If the instrument is reading **Specific Conductance**, the large numbers on the display will be followed by either a **mS** or an **mS**. Additionally, the small portion of the display will show the °C flashing on and off .

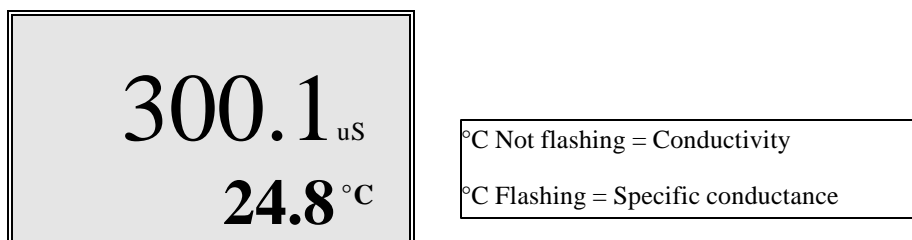

If the instrument is reading **Conductivity**, the large numbers on the display will be followed by either a **mS** or an **mS**. Additionally, the small portion of the display will show the °C **NOT** flashing.

If the instrument is reading **Salinity**, the large numbers on the display will be followed by a **ppt**.

### 3.3 AUTORANGING & RANGE SEARCHING

---

The YSI Model 30 is an autoranging instrument. This means that, regardless of the conductivity or salinity of the solution (within the specifications of the instrument), all you need to do to get the most accurate reading is to put the probe in the sample. This feature makes the Model 30 as simple as possible to operate.

When you first place the Model 30 probe into a sample or calibration solution, and again when you first remove the probe, the instrument will go into a range search mode that may take as long as 5 seconds. During some range searches, the instrument display will flash **rANG** to indicate its movement from one range to another.



The length of the range search depends on the number of ranges which must be searched in order to find the correct range for the sample. During the range search, the instrument will appear to freeze on a given reading for a few seconds then, once the range is located, will pinpoint the exact reading on the display. The display may also switch to **00.0** for a second or two during a range search before it selects the proper range.

During normal operation, the **ENTER** key (**UP ARROW** key on Model 30M) enables and disables the autoranging feature of the instrument. We recommend that the instrument always be operated using the autoranging feature. See Section 6, *Advanced Setup* if you need to switch to manual ranging.

### 3.4 THE BACKLIGHT

---

At times it may be necessary to take measurements with the Model 30 in dark or poorly lit areas. To help in this situation, the Model 30 comes equipped with a backlight which will illuminate the display so that it can be easily read. To activate the backlight, press and hold down the **LIGHT** key. The display will remain lit as long as the key is held down. When you release it, the light goes out to preserve battery life.

## SECTION 4 SAVING DATA

---

The Model 30M is equipped with non-volatile memory that is capable of storing up to 50 different sets of readings. Non-volatile means that you do not need to worry that your data will be lost due to a power failure or interruption, such as when the batteries are removed. The Model 30M will also assign a site identity number to each set of readings to allow easy review of the data. This feature is useful in situations where transcribing data is difficult or not available.

**NOTE: The Model 30 is NOT equipped with memory and cannot save data.**

### 4.1 SAVING DATA TO MEMORY

---

1. While any parameter is displayed on the screen, press the **ENTER** key and hold for approximately 2 seconds.

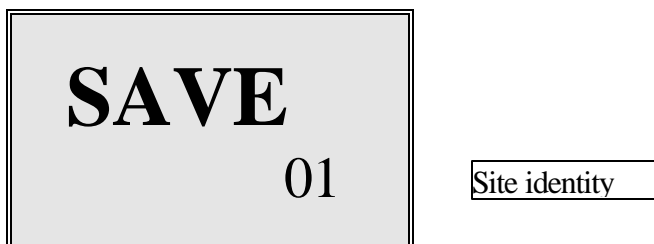

The meter will flash **SAVE** on the display along with the current site identity is being used.

2. When all 50 sites are full, the display will flash **FULL** on the screen. This message will remain on the screen (even after power down) until a key is pushed.



Once you have acknowledged the memory is full, any subsequent saved data will begin overwriting existing data starting with site #1.

## 4.2 RECALLING STORED DATA

---

1. To put the Model 30M into the **RECALL** mode, press the **MODE** key until **rcl** is displayed on the screen along with the site ID number in the lower right corner.

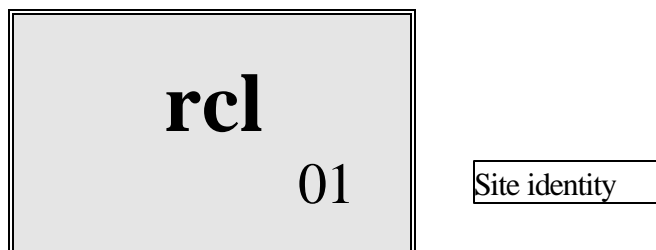

2. Press the **ENTER** key to review the last set of data that was saved. The Model 30M will display the conductivity and temperature. Another press of the **ENTER** key will display the specific conductance and the temperature. Press the **ENTER** key again to review the salinity which is also displayed with the temperature.
3. Press the **UP ARROW** key to increment through the saved sets of data.
4. Press the **DOWN ARROW** key to decrement through the saved sets of data.

**NOTE:** The Model 30M will recall data as a list. When the **UP ARROW** is pressed the Model 30M will display the Site ID# for the previously recorded data. For example: If you are reviewing Site ID# 5 and the **UP ARROW** is pressed, the Model 30M will display Site ID# 4. If you are reviewing Site ID# 5 and Site ID# 5 was the last set of data stored, the **DOWN ARROW** key will display Site ID# 1.

Here is an example of the Model 30M memory.

Site ID #1

Site ID #2

Site ID #3 —If the **UP ARROW** key was pressed the Model 30M would display Site ID #2

Site ID #4

Site ID #5

## 4.3 ERASING STORED DATA

---

1. To erase the data that is stored into the Model 30M's memory, press the **MODE** key until the Model 30M displays **ErAS** on the screen.



2. Press and hold both the **DOWN ARROW** and **ENTER** keys simultaneously for approximately 5 seconds.
3. Successful erasure is indicated by the Model 30M flashing **DONE** on the display for 1 to 2 seconds. The instrument will automatically change to normal operation after completion.



**IMPORTANT: Data in all 50 site ID's will be erased completely and will be lost forever. Do not use the erase function until all recorded data has been transcribed to an archive outside the Model 30M.**



# SECTION 5 CALIBRATION

---

## 5.1 BEFORE YOU CALIBRATE

---

**IMPORTANT:** System calibration is rarely required because of the factory calibration of the YSI Model 30. However, from time to time it is wise to check the system calibration and make adjustments when necessary.

Before you calibrate the YSI Model 30, complete the procedures discussed in the *Preparing the Meter* and *Making Measurements* sections of this manual.

To accurately calibrate the YSI Model 30, it is important to remember the following:

1. **Always use clean, properly stored, NIST traceable calibrator solutions** (see Appendix B, *Accessories and Replacement Parts*). When filling a calibration container prior to performing the calibration procedures, make certain that the level of calibrant buffers is high enough in the container to cover the entire conductivity cell. Gently agitate the probe to remove any bubbles in the conductivity cell.
2. Rinse the probe with deionized water (and wipe dry) between changes of calibration solutions.
3. During calibration, allow the probe time to stabilize with regard to temperature (approximately 60 seconds) before proceeding with the calibration process. **The readings after calibration are only as good as the calibration itself.**
4. Perform sensor calibration at a temperature as close to 25°C as possible. This will minimize any temperature compensation error.

## 5.2 THE CALIBRATION PROCESS

---

System calibration is rarely required because of the factory calibration of the YSI Model 30. However, from time to time it is wise to check the system calibration and make adjustments when necessary.

Follow these steps to perform an accurate calibration of the YSI Model 30:

1. Turn the instrument on and allow it to complete its self test procedure.
2. Select a calibration solution which is most similar to the sample you will be measuring.
  - For sea water choose a 50 mS/cm conductivity standard (YSI Catalog# 3169).
  - For fresh water choose a 1 mS/cm conductivity standard (YSI Catalog# 3167).
  - For brackish water choose a 10 mS/cm conductivity standard (YSI Catalog # 3168).
3. Place at least 3 inches of solution in a clean glass beaker.
4. Insert the probe into the beaker deep enough to completely cover the oval shaped hole on the side of the probe. Do not rest the probe on the bottom of the container -- suspend it above the bottom at least 1/4 inch.

5. Press the **MODE** key until the instrument is reading conductivity or specific conductance.
6. Allow at least 60 seconds for the temperature reading to become stable.
7. Move the probe vigorously from side to side to dislodge any air bubbles from the electrodes.
8. Press and release both the **UP ARROW** and **DOWN ARROW** keys at the same time. The **CAL** symbol will appear at the bottom left of the display to indicate that the instrument is now in Calibration mode.

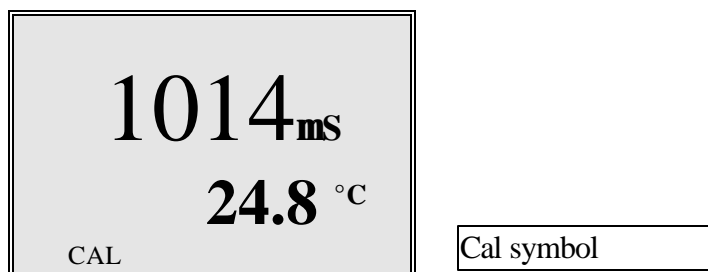

9. Use the **UP ARROW** or **DOWN ARROW** key to adjust the reading on the display until it matches the value of the calibration solution you are using.

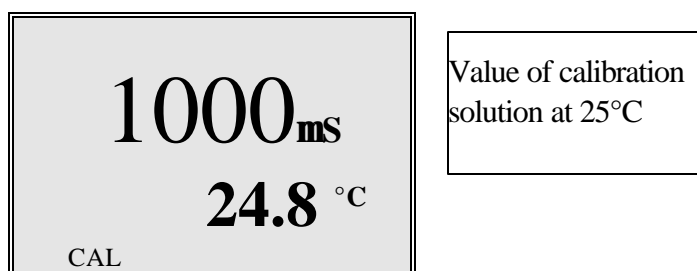

10. Once the display reads the exact value of the calibration solution being used (the instrument will make the appropriate compensation for temperature variation from 25°C), press the **ENTER** key. The word "**SAVE**" will flash across the display for a second indicating that the calibration has been accepted.



**NOTE:** If the up or down arrow keys are not pressed during the calibration process, the "SAVE" message will not be displayed since the calibration value has not changed. If an error occurs during calibration, see Section 9, *Troubleshooting*.

## SECTION 6 ADVANCED SETUP

---

The default settings of the YSI Model 30 are appropriate for the vast majority of measurement applications. However, some measurement applications require very specific measurement criteria. For that reason, we have made the YSI Model 30 flexible to accommodate these “advanced users.”

If, for example, you are using the YSI Model 30 for a process control application which requires that the conductivity readings be compensated to 20 °C instead of 25 °C -- this is the section to read. Or, if your application for the YSI Model 30 involves the measurement of a very specific saline solution, the default temperature coefficient may need to be changed to get the very best measurement of that specific salt.

**IMPORTANT:** There is never a need to enter Advanced Setup Mode unless your special measurement application calls for a change in reference temperature and/or temperature coefficient. Therefore, unless you are certain that your application requires a change to one or both of these criteria, do not modify the default reference temperature (25°C) or the default temperature coefficient (1.91%).

### 6.1 CHANGING THE TEMPERATURE COEFFICIENT

---

Follow these steps to modify the temperature coefficient of the Model 30.

1. Turn the instrument on and wait for it to complete its self test procedure.
2. Press and release both the **DOWN ARROW** and **MODE** keys at the same time. The **CAL** symbol will appear at the bottom left of the display and the large portion of the display will show **1.91%** (or a value set previously using Advanced Setup).

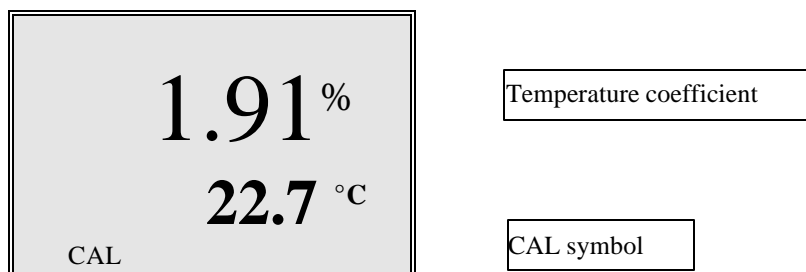

3. Use the **UP ARROW** or **DOWN ARROW** key to change the value to the desired new temperature coefficient.

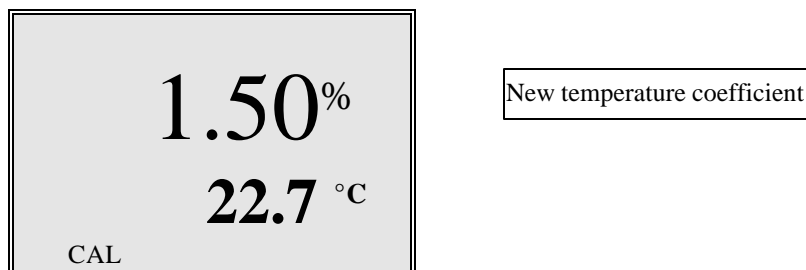

4. Press the **ENTER** key. The word “**SAVE**” will flash across the display for a second to indicate that your change has been accepted.
5. Press the **MODE** key to return to normal operation; the **CAL** symbol will disappear from the display.

See *Appendix C* for charts of common salt solutions at various temperatures.

## 6.2 CHANGING THE REFERENCE TEMPERATURE

---

Follow these steps to modify the reference temperature of the Model 30.

1. Turn the instrument on and wait for it to complete its self test procedure.
2. Press and release both the **DOWN ARROW** and **MODE** keys at the same time.

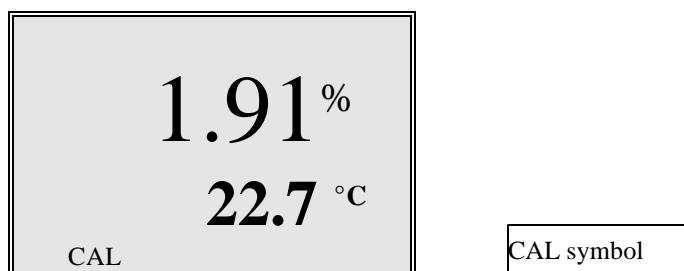

The **CAL** symbol will appear at the bottom left of the display and the large portion of the display will show **1.91%** (or a value set previously using Advanced Setup).

3. Press and release the **MODE** key; the large portion of the display will show **25.0C** (or a value set previously using Advanced Setup).

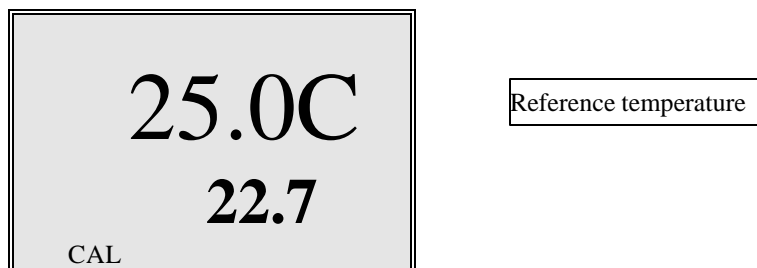

- Use the **UP ARROW** or **DOWN ARROW** key to change the value to the desired new reference temperature (any value between 15 °C and 25 °C is acceptable).

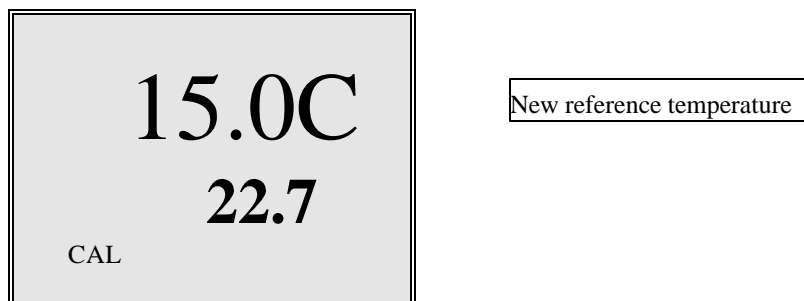

- Press the **ENTER** key. The word “**SAVE**” will flash across the display for a second to indicate that your change has been accepted. The instrument will automatically return to normal operation mode.

### 6.3 CHANGING FROM AUTORANGING TO MANUAL RANGING

---

If your application is easier to perform using a manual range which you select, the YSI Model 30 and Model 30M allow you to turn off the default autoranging feature. Follow the instructions for your model as shown below.

#### Model 30

While you are making conductivity or specific conductance measurements with the Model 30, simply press and release the **ENTER** key to select manual ranging.

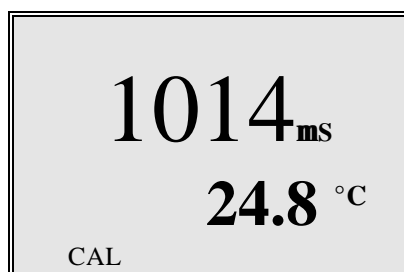

Each additional press of the **ENTER** key will cycle the Model 30 to a different manual range until you return again to autoranging. Five pushes of the **ENTER** key will cycle the Model 30 through the four manual ranges and return the instrument to autoranging.

**NOTE:** You may see an error message in some manual ranges if the manual range selected is not adequate for the sample you are measuring.

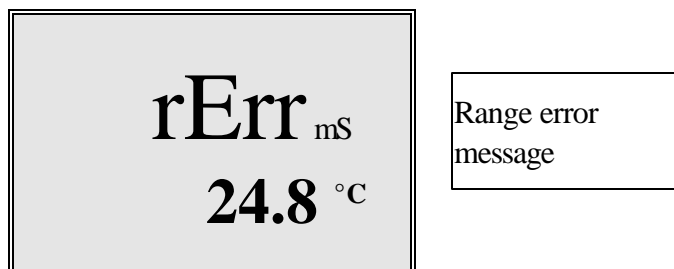

If this happens, simply press and release the **ENTER** key until a range is selected which is suitable for your sample. If you get lost and don't know if you're in a manual range or autoranging, simply turn the instrument off and back on. The instrument will always default to autoranging when first turned on.

### Model 30M

While you are making conductivity or specific conductance measurements with the Model 30M, simply press and release the **UP ARROW** key to select manual ranging. Note that the conductivity units will flash on the Model 30M to indicate that the instrument is in a manual range.

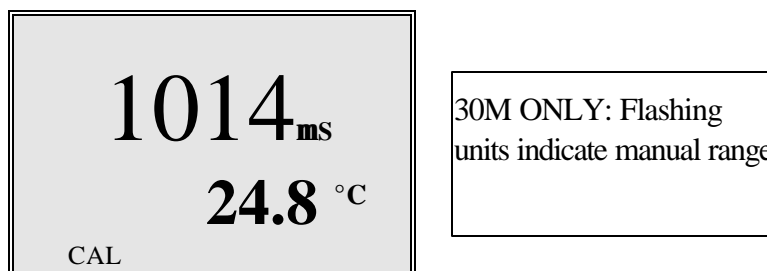

Each additional press of the **UP ARROW** key will cycle the Model 30M to a different manual range until you return again to autoranging. Five pushes of the **UP ARROW** key will cycle the Model 30M through the four manual ranges and return the instrument to autoranging.

**NOTE:** You may see an error message in some manual ranges if the manual range selected is not adequate for the sample you are measuring.

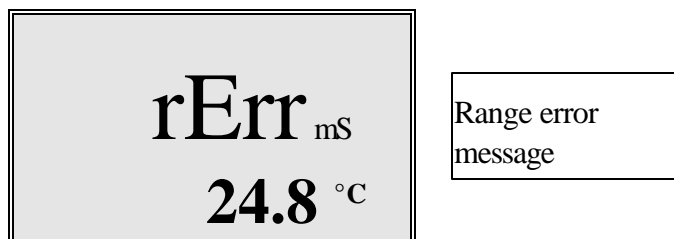

If this happens, simply press and release the **UP ARROW** key until a range is selected which is suitable for your sample. Note that the instrument will always default to autoranging when first turned on.

The four ranges of the YSI Model 30 are:

<b>Range 1</b>	<b>Range 2</b>	<b>Range 3</b>	<b>Range 4</b>
0 to 499.9 $\mu\text{S/cm}$	0 to 4999 $\mu\text{S/cm}$	0 to 49.99 $\text{mS/cm}$	0 to 200.0 $\text{mS/cm}$



## SECTION 7 PRINCIPLES OF OPERATION

---

The Model 30 utilizes a cell with four pure nickel electrodes for the measurement of solution conductance. Two of the electrodes are current driven and two are used to measure the voltage drop. The measured voltage drop is then converted into a conductance value in milliSiemens (millimhos). To convert this value to a conductivity value in milliSiemens per cm (mS/cm), the conductance is multiplied by the cell constant which has units of reciprocal cm ( $\text{cm}^{-1}$ ). The cell constant for the Model 30 conductivity cell is  $5.0/\text{cm} \pm 4\%$ . For most applications, the cell constant is automatically determined (or confirmed) with each deployment of the system when the calibration procedure is followed; see section 6.2. Solutions with conductivities of 1.00, 10.0, 50.0, and 100.0 mS/cm, which have been prepared in accordance with recommendation 56-1981 of the Organisation Internationale de Métrologie Légale (OIML), are available from YSI. The instrument output is in  $\mu\text{S}/\text{cm}$  or  $\text{mS}/\text{cm}$  for both conductivity and specific conductance. The multiplication of cell constant times conductance is carried out automatically by the software.

### 7.1 TEMPERATURE EFFECT

---

The conductivity of solutions of ionic species is highly dependent on temperature, varying as much as 3% for each change of one degree Celsius (temperature coefficient =  $3\%/^{\circ}\text{C}$ ). In addition, the temperature coefficient itself varies with the nature of the ionic species present. Because the exact composition of a natural media is usually not known, it is best to report a conductivity at a particular temperature, e.g. 20.2 mS/cm at  $14^{\circ}\text{C}$ . However, in many cases, it is also useful to compensate for the temperature dependence in order to determine at a glance if gross changes are occurring in the ionic content of the medium over time. For this reason, the Model 30 software also allows the user to output conductivity data in either raw or temperature compensated form. If "Conductivity" is selected, values of conductivity which are **NOT** compensated for temperature are output to the display. If "Specific Conductance" is selected, the Model 30 uses the temperature and raw conductivity values associated with each determination to generate a specific conductance value compensated to a user selected reference temperature (see section 6, *Advanced Setup*) between  $15^{\circ}\text{C}$  and  $25^{\circ}\text{C}$ . Additionally the user can select any temperature coefficient from 0% to 4% (see Section 6, *Advanced Setup*). Using the Model 30 default reference temperature and temperature coefficient ( $25^{\circ}\text{C}$  and 1.91%), the calculation is carried out as in equation (1) below:

$$\text{Specific Conductance } (25^{\circ}\text{C}) = \frac{\text{Conductivity}}{1 + \text{TC} * (\text{T} - 25)}$$

As noted above, unless the solution being measured consists of pure KCl in water, this temperature compensated value will be somewhat inaccurate, but the equation with a value of  $\text{TC} = 0.0191$  will provide a close approximation for solutions of many common salts such as NaCl and  $\text{NH}_4\text{Cl}$  and for seawater.

Salinity is determined automatically from the Model 30 conductivity readings according to algorithms found in *Standard Methods for the Examination of Water and Wastewater* (ed. 1995). The use of the Practical Salinity Scale 1978 results in values which are unitless, since the measurements are carried out in reference to the conductivity of standard seawater at 15°C. However, the unitless salinity values are very close to those determined by the previously-used method where the mass of dissolved salts in a given mass of water (parts per thousand) was reported. Hence, the designation "ppt" is reported by the instrument to provide a more conventional output.

For further information on conductivity and the above standard information, refer to the ASTM document, *Standard Methods of Test for Electrical Conductivity of Water and Industrial Wastewater*, ASTM Designation D1125-82, and OIML *Recommendation Number 56*. ASTM symbols for conductivity, cell constant, and path length differ from those preferred in the general literature and also from those used in this manual.

## 7.2 DISCUSSION OF MEASUREMENT ERRORS

---

System accuracy for conductivity measurements is equal to the sum of the errors contributed by the environment and the various components of the measurement setup. These include:

- Instrument accuracy
- Cell-constant error
- Solution temperature offset
- Cell contamination (including air bubbles)
- Electrical noise
- Galvanic effects

Only the first three are of major concern for typical measurements, although the user should also be careful to see that cells are clean and maintained in good condition at all times.

### **Instrument Accuracy = ± .5% maximum**

The accuracy specified for the range being used is the worst case instrument error.

### **Cell-Constant Error = ± .5% maximum**

Although YSI cells are warranted to be accurate to within one percent, you should still determine the exact cell constant of your particular cell. Contamination or physical damage to the cell can alter the cell constant. Performing a calibration will eliminate any error which might arise because of cell constant change.

YSI cells are calibrated to within one percent of the stated cell constant at a single point. We consider these products to be usefully linear over most instrument ranges. The cell constant can be calibrated to ±0.35% accuracy with YSI conductivity calibrator solutions.

### **Temperature Error = ± 1% maximum**

The solution temperature error is the product of the temperature coefficient and the temperature offset from 25°C, expressed as a percentage of the reading that would have been obtained at 25°C. The error is not necessarily a linear function of temperature. The statement of error is derived from a 25°C temperature offset and a 3%/°C temperature coefficient.

### **Total Error**

Considering only the above three factors, system accuracy under worst case conditions will be  $\pm 2\%$ , although the actual error will be considerably less if recommended and properly calibrated cells and instrument ranges are used. Additional errors, which can essentially be eliminated with proper handling, are described below.

### **Cell Contamination**

This error is usually due to contamination of the solution being measured, which occurs when solution is carried-over from the last solution measured. Thus, the instrument might be correctly reporting the conductivity seen, but the reading does not accurately represent the value of the bulk solution. Errors will be most serious when low conductivity solutions are contaminated by carry-over from high conductivity solutions, and can then be of an order of magnitude or more.

Follow the cleaning instructions carefully before attempting low conductivity measurements with a cell of unknown history or one that has been previously used in higher value solutions.

An entirely different form of contamination sometimes occurs due to a buildup of foreign material directly on cell electrodes. While rare, such deposits have, on occasion, markedly reduced the effectiveness of the electrodes. The result is an erroneously low conductance reading.

### **Electrical-Noise Errors**

Electrical noise can be a problem in any measurement range, but will contribute the most error and be the most difficult to eliminate when operating in the lowest ranges. The noise may be either line-conducted or radiated or both, and may require, grounding, shielding, or both.

### **Galvanic and Miscellaneous Effects**

In addition to the error sources described above, there is another class of contributors that can be ignored for all but the most meticulous of laboratory measurements. These errors are always small and are generally completely masked by the error budget for cell-constant calibration, instrument accuracy, etc. Examples range from parasitic reactances associated with the solution container and its proximity to external objects to the minor galvanic effects resulting from oxide formation or deposition on electrodes. Only trial and error in the actual measurement environment can be suggested as an approach to reduce such errors. If the reading does not change as the setup is adjusted, errors due to such factors can be considered too small to see.



## SECTION 8 MAINTENANCE

---

### 8.1 CLEANING AND STORAGE

---

The single most important requirement for accurate and reproducible results in conductivity measurement is a clean cell. A dirty cell will change the conductivity of a solution by contaminating it.

**NOTE:** ALWAYS RINSE THE CONDUCTIVITY CELL WITH CLEAN WATER AFTER EACH USE.

To clean the conductivity cell:

1. Dip the cell in cleaning solution and agitate for two to three minutes. Any one of the foaming acid tile cleaners, such as Dow Chemical Bathroom Cleaner, will clean the cell adequately. When a stronger cleaning preparation is required, use a solution of 1:1 isopropyl alcohol and 10N HCl. Remove the cell from the cleaning solution.
2. Use the nylon brush (supplied) to dislodge any contaminants from inside the electrode chamber.

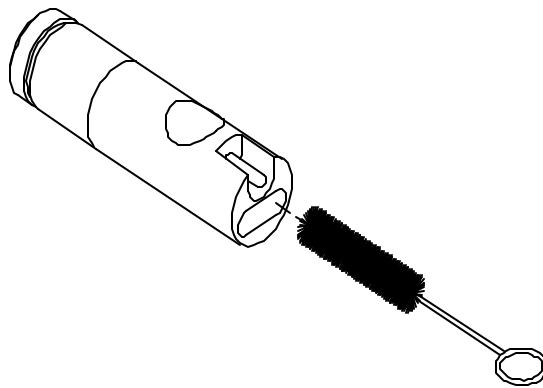

3. Repeat steps one and two until the cell is completely clean. Rinse the cell thoroughly in deionized, or clean tap water.
4. Store the conductivity cell in the meter storage chamber.

### 8.2 PROBE PRECAUTIONS

---

Observe the following precautions to ensure accurate, repeatable results:

1. The cell must be clean before making any measurements. When working with substances having low conductivity, extraordinary cleanliness may be required.
2. Suspend the cell in the solution deep enough to submerge the vent hole. The electrode chamber should be free of trapped air. You may need to tap the probe gently to dislodge any air bubbles.
3. Ideally, the cell should be at least ¼ inch away from any other object, including the sides or bottom of the solution container.

4. Stirring may be necessary for highest accuracy measurements, especially in low-conductivity solutions.
5. If possible, isolate from ground potential the container or system in which measurements are to be made.
6. Electrical fields and stray currents caused by stirrer motors, heaters, etc., can interfere with measurements. The user should determine the effects of these and make the necessary corrections, either by shielding or by disconnecting those units that cause trouble.
7. Always rinse the cell carefully before transferring it from one solution to another.
8. Never store a dirty or contaminated cell.

## SECTION 9 TROUBLESHOOTING

The following is a list of error codes for the Model 30 and Model 30M. The Model 30M also has additional error codes (see the following page).

SYMPTOM	POSSIBLE CAUSE	ACTION
1. Instrument will not turn on	A. Low battery voltage B. Batteries installed wrong C. Meter requires service	A. Replace batteries B. Check battery polarity. C. Return system for service
2. Instrument will not calibrate	A. Incorrect calibration procedure B. Cell needs cleaning C. Instrument requires Service	A. See section 5 <i>Calibration</i> B. See section 8 <i>Maintenance</i> C. Return system for service
3. Instrument "locks up"	A. Instrument has received a shock B. Batteries are low or damaged C. System requires service	A. Remove battery lid, wait 15 seconds for reset, replace lid. B. Replace batteries C. Return system for service
4. Instrument readings are inaccurate	D. Calibration is required E. Cell is contaminated F. Temperature coefficient has been set incorrectly G. Reference temperature incorrect H. Readings are or are not temperature compensated.	D. See section 5 <i>Calibration</i> E. See section 8 <i>Maintenance</i> F. See section 6 <i>Advanced Setup</i> G. See section 6 <i>Advanced Setup</i> H. See section 3 <i>Making Measurements</i>
5. LCD displays "LO BAT"	A. Batteries are low or damaged	A. Replace batteries
6. Main Display reads "OVER"	I. Conductivity Reading is >200 mS J. Temp. Reading is > 95° C K. Temp. Reading is <-5° C L. Salinity reading is > 80 ppt M. During calibration, calculated cell constant is >K=5.25	I. In all cases, check calibration values and procedure; check Advanced Setup settings. J. If each of these is set correctly, return system for service.
7. Main Display reads "Undr"	A. During calibration, calculated cell constant is <K=4.9	A. Recalibrate instrument using known good conductivity standard B. Follow cell cleaning procedure see section 8 <i>Maintenance</i> .
8. Main Display reads "rErr"	N. User has selected manual ranging & sample exceeds selected range	K. Use the mode key to select a higher or lower manual range, or to set system to Autoranging.
9. Main Display reads "PErr"	O. Incorrect sequence of key strokes	A. Refer to manual section which provides step by step procedures

<b>SYMPTOM</b>	<b>POSSIBLE CAUSE</b>	<b>ACTION</b>
		for the function you are attempting.

<b>SYMPTOM</b>	<b>POSSIBLE CAUSE</b>	<b>ACTION</b>
10. Main Display reads "LErr"	A. In specific conductance mode, temperature exceeds the values computed using user defined temperature coefficient and/or reference temperature  B. During calibration, temperature exceeds the values computed using user defined temperature coefficient and/or reference temperature	A. & B. Adjust user defined temperature coefficient and/or reference temperature (See section 6 <i>Advanced Setup</i> )
11. Main Display reads "Err" Secondary Display reads "ra"	A. System has failed its RAM test check procedure	A. Turn instrument OFF and back ON. B. Return the system for service.
12. Main Display reads "Err" Secondary Display reads "ro"	A. System has failed its ROM test check procedure	A. Turn instrument OFF and back ON. B. Return the system for service.
13. Secondary Display reads "ovr"	A. Temperature is > 95° C	A. Read solution of lower temperature B. Return system for service C. Replace Probe/Cable assy.
14. Secondary Display reads "udr"	A. Temperature is < -5° C	A. Read solution of higher temperature B. Return system for service C. Replace Probe/Cable assy.
15. Secondary Display reads "rEr"	A. Temperature jumper is set to °F and reading is >199.9 °F but < 203 °F	A. Set jumper to read °C. B. Return system for service

The Model 30M has additional error codes as follows:

<b>SYMPTOM</b>	<b>POSSIBLE CAUSE</b>	<b>ACTION</b>
1. Readings on main display don't change	A. Meter is in recall mode.	A. Press MODE key to return to Normal Operation
2. Main Display reads "nOnE"	A. During recall, no data is currently stored in memory.	A. Store data before attempting to recall

## **SECTION 10                      WARRANTY AND REPAIR**

---

YSI Model 30 Salinity, Conductivity and Temperature Meters are warranted for two years from date of purchase by the end user against defects in materials and workmanship. YSI Model 30 probes and cables are warranted for one year from date of purchase by the end user against defects in material and workmanship. Within the warranty period, YSI will repair or replace, at its sole discretion, free of charge, any product that YSI determines to be covered by this warranty.

To exercise this warranty, write or call your local YSI representative, or contact YSI Customer Service in Yellow Springs, Ohio. Send the product and proof of purchase, transportation prepaid, to the Authorized Service Center selected by YSI. Repair or replacement will be made and the product returned, transportation prepaid. Repaired or replaced products are warranted for the balance of the original warranty period, or at least 90 days from date of repair or replacement.

### **Limitation of Warranty**

This Warranty does not apply to any YSI product damage or failure caused by (i) failure to install, operate or use the product in accordance with YSI's written instructions, (ii) abuse or misuse of the product, (iii) failure to maintain the product in accordance with YSI's written instructions or standard industry procedure, (iv) any improper repairs to the product, (v) use by you of defective or improper components or parts in servicing or repairing the product, or (vi) modification of the product in any way not expressly authorized by YSI.

THIS WARRANTY IS IN LIEU OF ALL OTHER WARRANTIES, EXPRESSED OR IMPLIED, INCLUDING ANY WARRANTY OF MERCHANTABILITY OR FITNESS FOR A PARTICULAR PURPOSE. YSI's LIABILITY UNDER THIS WARRANTY IS LIMITED TO REPAIR OR REPLACEMENT OF THE PRODUCT, AND THIS SHALL BE YOUR SOLE AND EXCLUSIVE REMEDY FOR ANY DEFECTIVE PRODUCT COVERED BY THIS WARRANTY. IN NO EVENT SHALL YSI BE LIABLE FOR ANY SPECIAL, INDIRECT, INCIDENTAL OR CONSEQUENTIAL DAMAGES RESULTING FROM ANY DEFECTIVE PRODUCT COVERED BY THIS WARRANTY.

## AUTHORIZED U.S. SERVICE CENTERS

### North Region

YSI Incorporated • Repair Center • 1725 Brannum Lane • Yellow Springs, Ohio • 45387 • Phone: (800) 765-4974 • (937) 767-7241 • E-Mail: info@ysi.com

### South Region

C.C. Lynch & Associates • 212 E. 2nd Street • Suite 203 • Pass Christian, Mississippi • 39571 • Phone: (800) 333-2252 • (228) 452-4612 • Fax: (228) 452-2563

### East Region

YSI Massachusetts, Inc. • 13 Atlantis Drive • Marion, MA • 02738 • Phone: (508)748-0366 • Fax (508)748-2543

### West Region

EnviroServices & Repair • 1110 Burnett Avenue, Suite D • Concord, CA • 94520 • Phone: (800)550-5875 • Fax: (510)674-8655

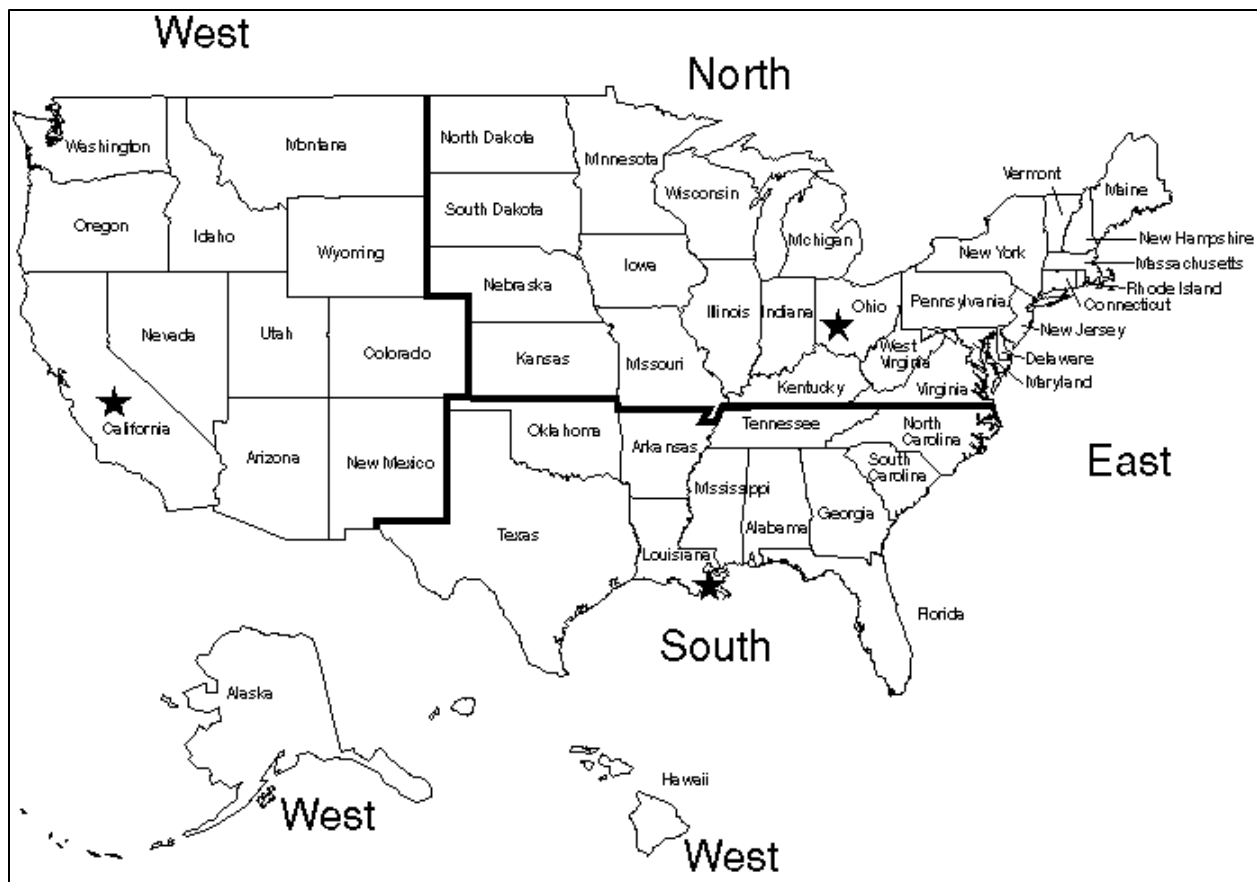

## **INTERNATIONAL SERVICE CENTERS**

---

YSI Incorporated • Repair Center • 1725 Brannum Lane • Yellow Springs, Ohio • 45387 • Phone: (937) 767-7241 • E-Mail: info@ysi.com

Lynchford House • Lynchford Lane • Farnborough • Hampshire • GU146LT • Phone: (44-1252) 514711 • Fax: (44-1252) 511855 • Tlx: 858210

Sakura – Building 6-5-6-13 • Shinjuku, Shinjuku-ku, Tokyo • 160 • Phone: (81-3) 5360-3561 • Fax: (81-3) 5360-3565

## **SPECIALTY SERVICE CENTERS**

---

### **Aquaculture**

Aquatic Eco Systems, Inc. • 1767 Benbow Court • Apopka, Florida • Phone: (407) 886-3939 • Fax: (407) 886-6787

Aquacenter • 166 Seven Oaks Road • Leland, Mississippi • 38756 • Phone: (601) 378-2861 • Fax: (601) 378-2862

### **Wastewater**

Q.C. Services • P.O. Box 68 • Harrison, Maine • 04040 • Phone: (207) 583-2980

Q.C. Services • P.O. Box 14831 • Portland, Oregon • 97293 • Phone: (503) 236-2712

## CLEANING INSTRUCTIONS

---

**NOTE: Before they can be serviced, equipment exposed to biological, radioactive, or toxic materials must be cleaned and disinfected.**

Biological contamination is presumed for any instrument, probe, or other device that has been used with body fluids or tissues, or with waste water. Radioactive contamination is presumed for any instrument, probe or other device that has been used near any radioactive source.

If an instrument, probe, or other part is returned or presented for service without a Cleaning Certificate, and if in our opinion it represents a potential biological or radioactive hazard, our service personnel reserve the right to withhold service until appropriate cleaning, decontamination, and certification has been completed. We will contact the sender for instructions as to the disposition of the equipment. Disposition costs will be the responsibility of the sender.

When service is required, either at the user's facility or at YSI, the following steps must be taken to insure the safety of our service personnel.

1. In a manner appropriate to each device, decontaminate all exposed surfaces, including any containers. 70% isopropyl alcohol or a solution of 1/4 cup bleach to 1 gallon tap water are suitable for most disinfecting. Instruments used with waste water may be disinfected with .5% Lysol if this is more convenient to the user.
2. The user shall take normal precautions to prevent radioactive contamination and must use appropriate decontamination procedures should exposure occur.
3. If exposure has occurred, the customer must certify that decontamination has been accomplished and that no radioactivity is detectable by survey equipment.
4. Any product being returned to the YSI Repair Center, should be packed securely to prevent damage.
5. Cleaning must be completed and certified on any product before returning it to YSI.

## **PACKING INSTRUCTIONS**

---

1. Clean and decontaminate items to insure the safety of the handler.
2. Complete and include the Cleaning Certificate.
3. Place the product in a plastic bag to keep out dirt and packing material.
4. Use a large carton, preferably the original, and surround the product completely with packing material.
5. Insure for the replacement value of the product.

<b><u>Cleaning Certificate</u></b>	
Organization	_____
Department	_____
Address	_____
City	_____ State _____ Zip _____
Country	_____ Phone _____
Model No. of Device	_____ Lot Number _____
Contaminant (if known)	_____
Cleaning Agent(s) used	_____
Radioactive Decontamination Certified?	
(Answer only if there has been radioactive exposure)	
_____ Yes	_____ No
Cleaning Certified By	_____
Name	Date



## **APPENDIX A      REQUIRED NOTICE**

---

The Federal Communications Commission defines this product as a computing device and requires the following notice:

This equipment generates and uses radio frequency energy and if not installed and used properly, may cause interference to radio and television reception. There is no guarantee that interference will not occur in a particular installation. If this equipment does cause interference to radio or television reception, which can be determined by turning the equipment off and on, the user is encouraged to try to correct the interference by one or more of the following measures:

- re-orient the receiving antenna
- relocate the computer with respect to the receiver
- move the computer away from the receiver
- plug the computer into a different outlet so that the computer and receiver are on different branch circuits.

If necessary, the user should consult the dealer or an experienced radio/television technician for additional suggestions. The user may find the following booklet, prepared by the Federal Communications Commission, helpful: "How to Identify and Resolve Radio-TV Interference Problems." This booklet is available from the U.S. Government Printing Office, Washington, D.C. 20402, Stock No. 0004-000-00345-4.



## APPENDIX B      ACCESSORIES AND REPLACEMENT PARTS

---

The following parts and accessories are available from YSI or any Franchise Dealer authorized by YSI.

YSI Order Number	Description
3161	Conductivity Calibrator Solution 1,000 $\mu\text{S}/\text{cm}$ (1 Quart)
3163	Conductivity Calibrator Solution 10,000 $\mu\text{S}/\text{cm}$ (1 Quart)
3165	Conductivity Calibrator Solution 100,000 $\mu\text{S}/\text{cm}$ (1 Quart)
3167	Conductivity Calibrator Solution 1,000 $\mu\text{S}/\text{cm}$ (8 pints)
3168	Conductivity Calibrator Solution 10,000 $\mu\text{S}/\text{cm}$ (8 pints)
3169	Conductivity Calibrator Solution 50,000 $\mu\text{S}/\text{cm}$ (8 pints)
5520	Carrying Case
110030	Replacement Probe & Cable Assembly (10 feet)
110031	Replacement Probe & Cable Assembly (25 feet)
110032	Replacement Probe & Cable Assembly (50 feet)
030131	Replacement Front Case Cover
055242	Replacement Rear Case Cover
055244	Replacement Battery Cover Kit
055204	Replacement Case Gasket and Screw, Model 30
055219	Storage Chamber Sponge
038213	Replacement Electrode Cleaning Brush
030133	Replacement PCB Assy., Model 30
030155	Replacement PCB Assy., Model 30M



# APPENDIX C TEMPERATURE CORRECTION

This data is for typical applications of the YSI sondes.

## A. Potassium Chloride\*\* (KCl)

Concentration: 1 mole/liter			Concentration: $1 \times 10^{-1}$ mole/liter		
°C	mS/cm	%/°C (to 25°C)	°C	mS/cm	%/°C (to 25°C)
0	65.10	1.67	0	7.13	1.78
5	73.89	1.70	5	8.22	1.80
10	82.97	1.72	10	9.34	1.83
15	92.33	1.75	15	10.48	1.85
20	101.97	1.77	20	11.65	1.88
25	111.90	1.80	25	12.86	1.90
			30	14.10	1.93
			35	15.38	1.96
			37.5	16.04	1.98
			40	16.70	1.99
			45	18.05	2.02
			50	19.43	2.04

Concentration: $1 \times 10^{-2}$ mole/liter			Concentration: $1 \times 10^{-3}$ mole/liter		
°C	mS/cm	%/°C (to 25°C)	°C	mS/cm	%/°C (to 25°C)
0	0.773	1.81	0	0.080	1.84
5	0.892	1.84	5	0.092	1.88
10	1.015	1.87	10	0.105	1.92
15	1.143	1.90	15	0.119	1.96
20	1.275	1.93	20	0.133	1.99
25	1.412	1.96	25	0.147	2.02
30	1.553	1.99	30	0.162	2.05
35	1.697	2.02	35	0.178	2.07
37.5	1.771	2.03	37.5	0.186	2.08
40	1.845	2.05	40	0.194	2.09
45	1.997	2.07	45	0.210	2.11
50	2.151	2.09	50	0.226	2.13

\*\* Charts developed by interpolating data from *International Critical Tables*, Vol. 6, pp. 229-253, McGraw-Hill Book Co., NY.

**B. Sodium Chloride\* (NaCl)**

Saturated solutions at all temperatures			Concentration: 0.5 mole/liter		
°C	mS/cm	%/°C (to 25°C)	°C	mS/cm	%/°C (to 25°C)
0	134.50	1.86	0	25.90	1.78
5	155.55	1.91	5	29.64	1.82
10	177.90	1.95	10	33.61	1.86
15	201.40	1.99	15	37.79	1.90
20	225.92	2.02	20	42.14	1.93
25	251.30	2.05	25	46.65	1.96
30	277.40	2.08	30	51.28	1.99
			35	56.01	2.01
			37.5	58.40	2.02
			40	60.81	2.02
			45	65.65	2.04
			50	70.50	2.05

Concentration: $1 \times 10^{-1}$ mole/liter			Concentration: $1 \times 10^{-2}$ mole/liter		
°C	mS/cm	%/°C (to 25°C)	°C	mS/cm	%/°C (to 25°C)
0	5.77	1.83	0	0.632	1.87
5	6.65	1.88	5	0.731	1.92
10	7.58	1.92	10	0.836	1.97
15	8.57	1.96	15	0.948	2.01
20	9.60	1.99	20	1.064	2.05
25	10.66	2.02	25	1.186	2.09
30	11.75	2.04	30	1.312	2.12
35	12.86	2.06	35	1.442	2.16
37.5	13.42	2.07	37.5	1.508	2.17
40	13.99	2.08	40	1.575	2.19
45	15.14	2.10	45	1.711	2.21
50	16.30	2.12	50	1.850	2.24

Concentration: $1 \times 10^{-3}$ mole/liter		
°C	mS/cm	%/°C (to 25°C)
0	0.066	1.88
5	0.076	1.93
10	0.087	1.98
15	0.099	2.02
20	0.111	2.07
25	0.124	2.11
30	0.137	2.15
35	0.151	2.19
37.5	0.158	2.20
40	0.165	2.22
45	0.180	2.25
50	0.195	2.29

\* Charts developed by interpolating data from the *CRC Handbook of Chemistry and Physics*, 42nd ed., p. 2606, The Chemical Rubber Company, Cleveland.

**C. Lithium Chloride\* (LiCl)**

Concentration: 1 mole/liter			Concentration: 1 x 10 <sup>-1</sup> mole/liter		
°C	mS/cm	%/°C (to 25°C)	°C	mS/cm	%/°C (to 25°C)
0	39.85	1.82	0	5.07	1.87
5	46.01	1.85	5	5.98	1.85
10	52.42	1.89	10	6.87	1.85
15	59.07	1.92	15	7.75	1.85
20	65.97	1.95	20	8.62	1.85
25	73.10	1.98	25	9.50	1.86
30	80.47	2.02	30	10.40	1.88
35	88.08	2.05	35	11.31	1.91
37.5	91.97	2.07	37.5	11.78	1.92
40	95.92	2.08	40	12.26	1.94
45	103.99	2.11	45	13.26	1.98
50	112.30	2.15	50	14.30	2.02

Concentration: 1 x 10 <sup>-2</sup> mole/liter			Concentration: 1 x 10 <sup>-3</sup> mole/liter		
°C	mS/cm	%/°C (to 25°C)	°C	mS/cm	%/°C (to 25°C)
0	0.567	1.88	0	0.059	1.93
5	0.659	1.92	5	0.068	2.03
10	0.755	1.96	10	0.078	2.12
15	0.856	2.00	15	0.089	2.19
20	0.961	2.04	20	0.101	2.25
25	1.070	2.08	25	0.114	2.28
30	1.183	2.12	30	0.127	2.31
35	1.301	2.16	35	0.140	2.32
37.5	1.362	2.18	37.5	0.147	2.32
40	1.423	2.20	40	0.154	2.31
45	1.549	2.24	45	0.166	2.29
50	1.680	2.28	50	0.178	2.25

**D. Potassium Nitrate\*\* (KNO<sub>3</sub>)**

Concentration: 1 x 10 <sup>-1</sup> mole/liter			Concentration: 1 x 10 <sup>-2</sup> mole/liter		
°C	mS/cm	%/°C (to 25°C)	°C	mS/cm	%/°C (to 25°C)
0	6.68	1.78	0	0.756	1.77
5	7.71	1.79	5	0.868	1.80
10	8.75	1.81	10	0.984	1.83
15	9.81	1.83	15	1.105	1.86
20	10.90	1.85	20	1.229	1.88
25	12.01	1.87	25	1.357	1.90
30	13.15	1.90	30	1.488	1.93
35	14.32	1.92	35	1.622	1.95
37.5	14.92	1.94	37.5	1.690	1.96
40	15.52	1.95	40	1.759	1.97
45	16.75	1.97	45	1.898	1.99
50	18.00	2.00	50	2.040	2.01

\* Charts developed by interpolating data from the *CRC Handbook of Chemistry and Physics*, 42nd ed., p. 2606, The Chemical Rubber Company, Cleveland.

\*\* Charts developed by interpolating data from *International Critical Tables*, Vol. 6, pp. 229-253, McGraw-Hill Book Co., NY.

**E. Ammonium Chloride\* (NH<sub>4</sub>Cl)**

Concentration: 1 mole/liter			Concentration: 1 x 10 <sup>-1</sup> mole/liter		
°C	mS/cm	%/°C (to 25°C)	°C	mS/cm	%/°C (to 25°C)
0	64.10	1.60	0	6.96	1.82
5	74.36	1.53	5	7.98	1.88
10	83.77	1.45	10	9.09	1.93
15	92.35	1.37	15	10.27	1.97
20	100.10	1.29	20	11.50	2.00
25	107.00	1.21	25	12.78	2.03
			30	14.09	2.06
			35	15.43	2.07
			37.5	16.10	2.08
			40	16.78	2.08
			45	18.12	2.09
			50	19.45	2.09

Concentration: 1 x 10 <sup>-2</sup> mole/liter			Concentration: 1 x 10 <sup>-3</sup> mole/liter		
°C	mS/cm	%/°C (to 25°C)	°C	mS/cm	%/°C (to 25°C)
0	0.764	1.84	0	0.078	1.88
5	0.889	1.86	5	0.092	1.90
10	1.015	1.88	10	0.105	1.91
15	1.144	1.91	15	0.119	1.93
20	1.277	1.94	20	0.133	1.95
25	1.414	1.97	25	0.148	1.98
30	1.557	2.02	30	0.162	2.01
35	1.706	2.06	35	0.178	2.04
37.5	1.782	2.08	37.5	0.186	2.06
40	1.860	2.10	40	0.194	2.07
45	2.020	2.14	45	0.210	2.11
50	2.186	2.18	50	0.227	2.15

\* Charts developed by interpolating data from the *CRC Handbook of Chemistry and Physics*, 42nd ed., p. 2606, The Chemical Rubber Company, Cleveland.

## APPENDIX D

## CONVERSION CHART

---

To Convert From	To	Equation
Feet	Meters	Multiply by 0.3048
Meters	Feet	Multiply by 3.2808399
Degrees Celsius	Degrees Fahrenheit	$9/5 \times (^{\circ}\text{C}) + 32$
Degrees Fahrenheit	Degrees Celsius	$5/9 \times (^{\circ}\text{F} - 32)$
Milligrams per liter (mg/l)	Parts per million (ppm)	Multiply by 1



## APPENDIX E GLOSSARY

---

**ampere (A)** - SI unit of electric current

**amplitude** - The maximum deviation of an alternating current from its average value during its cycle.

**ASTM** - American Society for Testing and Materials

**calibrate** - To determine, check, or rectify the graduation of any instrument giving quantitative measurements.

**calibrator solution** - A solution of known value used to calibrate.

**capacitance (C)** - The ratio of the total charge on an isolated conductor to its potential; the property of being able to collect a charge of electricity.  $C = Q/V$ .

**capacitor** - An electrical component able to accumulate and hold an electric charge.

**cell constant (K)** - The ratio of the distance between two electrodes to the area normal to the current flow.  $K=d/A$ .

**cgs** - Abbreviation for the centimeter-gram-second system of units. Mostly superseded by SI units.

**conductance (k)** - The ratio of the current in a conductor to the potential difference between its ends; the ability of a conductor to transmit current; the reciprocal of resistance. The SI unit is siemens (S), also measured in mhos.

**conductivity ( $\kappa$ )** - The ratio of the current density in a conductor to the electric field causing the current to flow; the inverse of resistivity; the conductance between opposite faces of a cube of the measured material of 1 cm (cgs units) or 1 m (SI units) edge. Measured in mhos/cm (cgs units) or S/m (SI units)

**conductivity cell** - Any cell with electrodes used to measure the conductivity of liquid.

**current (I)** - The rate of flow of an electric charge, usually expressed in amperes.

**electrode** - A conductor whereby an electric current enters or leaves a liquid, gas, or vacuum.

**ion** - Any atom or molecule that has an electric charge due to the loss or gain of valence electrons.

**mks** - Abbreviation for the meter-kilogram-second system of units.

**mho** - A unit of conductance; the reciprocal of an ohm.

**micro ( $\mu$ )** - The metric prefix indicating  $10^{-6}$ .

**milli (m)** - The metric prefix indicating  $10^{-3}$ .

**NIST** - National Institute of Standards and Technology. The US government agency that defines measurement standards in the United States.

**ohm ( $\Omega$ )** - SI unit of resistance

**OIML** - Organisation Internationale de Métrologie Légale

**polarization** - The separation of the positive and negative charges of a molecule by an external agent.

**Pyrex** - A trademark name for heat-resistant and chemical-resistant glass.

**reference voltage** - A closely controlled d.c. or a.c. voltage used as a reference.

**SI** - Système International

**siemens (S)** - SI unit of electrical conductance; the reciprocal of an ohm; equivalent to a mho.

**temperature correction** - An adjustment made to a measurement to compensate for the difference between the measured and nominal temperatures.

**temperature coefficient** - The change in any particular physical quantity per degree change in temperature.

**voltage** - Electromotive force or potential expressed in volts.

# APPENDIX F GENERAL SPECIFICATIONS

---

## Probe Operating Environment

Medium: fresh, sea, or polluted water and most other liquid solutions.

Temperature: -5 to +95°C

Depth: 0 to 10, 0 to 25, or 0-50 feet (depending on cable length)

**Meter Ambient Operating/Storage Temperature:** -10 to +50°C

**Material:** ABS, Stainless Steel, and other materials.

## Dimensions:

Height: 9.5 inches (24.13 cm)

Thickness: 2.2 inches (5.6 cm)

Width: 3.5 inches max. (8.89 cm)

Weight: 1.7 pounds (w/ 10' cable) (0.77 kg)

Display 2.3"W x 1.5"L (5.8 cm W x 3.8 cm L)

**Power:** 9 VDC - 6 AA-size Alkaline Batteries (included)

Approximately 100 hours operation from each new set of batteries

**Water Tightness:** Meets or exceeds IP65 standards

*Extensive testing of the YSI Model 30 indicates the following typical performance:*

MEASUREMENT	RANGE	RESOLUTION	ACCURACY
Conductivity	0 to 499.9 $\mu$ S/cm	0.1 $\mu$ S/cm	$\pm$ 0.5% FS*
	0 to 4999 $\mu$ S/cm	1.0 $\mu$ S/cm	$\pm$ 0.5% FS
	0 to 49.99 mS/cm	0.01 mS/cm	$\pm$ 0.5% FS
	0 to 200.0 mS/cm	0.1 mS/cm	$\pm$ 0.5% FS
Salinity	0-80 ppt	0.1 ppt	$\pm$ 2%, or $\pm$ 0.1 ppt
Temperature	-5 to 95° C	0.1° C	$\pm$ 0.1° C ( $\pm$ 1 lsd)

\* For 50 Ft. cables, specification is for specific conductance > 100  $\mu$ S/cm

**Adjustable Reference Temperature:** 15° C - 25° C

**Adjustable Temperature Compensation Factor:** 0% - 4%

**Temperature Compensation:** Automatic

**Range:** User selected or Autoranging

**Data Storage:** 50 points with ID (Model 30M only)

*Y S I incorporated*



1700/1725 Brannum Lane  
Yellow Springs, Ohio 45387 USA  
(800) 765-4974 (937) 767-7241  
FAX: (937) 767-9320  
Website: <http://www.yssi.com>  
E-Mail: [info@ysi.com](mailto:info@ysi.com)

DRW # A30136D  
May 1998  
Item # 030136